

Chip Inductor ASCH Series

**Automotive
AEC-Q200**

RoHS Compliant
Halogen Free
REACH Compliant



- Noise
Suppression
- Shield
- Multilayer
- Ceramic
- High
Frequency

Part Numbering

A	SCH	00	100505	1N0	S	CP
Grade	Series Name	Control Code	Dimensions Code (mm)	Inductance (nH)	Tolerance	Internal Code
			100505 1.0x0.5x0.5	1N0 1.0	S ±0.3nH	00 General
			160808 1.6x0.8x0.8	10N 10	J ±5%	CP Low RDC
				R10 100		

This specification applies to Wire Wound Chip Inductors for Automotive Electronics based on AEC-Q200 except for Power train and Safety.

Please be sure to request approval specifications that provide further details of the products. Kindly note that the content of these specifications are subject to change or may be discontinued without prior notice. This product may not be designed/used in medical or high risk applications without Chilisin approval. Please contact our sales department before ordering.

ASCH00100505_CP Type

■ Dimensions

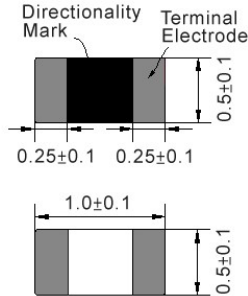

unit:mm

■ Recommended Land Pattern

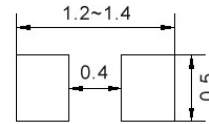

unit:mm

■ Electrical Characteristics

Part No.	Inductance	L,Q	Q	SRF	RDC	Rated Current	Tolerance
	(nH)	Test Freq.	Min.	(MHz)Min.	(Ω)Max.	(mA)Max.	(±%)
ASCH001005051N0□CP	1.0	100 MHz,200 mV	8	10000	0.07	400	±0.3nH
ASCH001005051N1□CP	1.1	100 MHz,200 mV	8	10000	0.10	400	±0.3nH
ASCH001005051N2□CP	1.2	100 MHz,200 mV	8	10000	0.09	400	±0.3nH
ASCH001005051N3□CP	1.3	100 MHz,200 mV	8	9000	0.10	400	±0.3nH
ASCH001005051N5□CP	1.5	100 MHz,200 mV	8	9000	0.10	400	±0.3nH
ASCH001005051N6□CP	1.6	100 MHz,200 mV	8	8700	0.10	400	±0.3nH
ASCH001005051N8□CP	1.8	100 MHz,200 mV	8	8700	0.10	400	±0.3nH
ASCH001005052N0□CP	2.0	100 MHz,200 mV	8	8100	0.10	400	±0.3nH
ASCH001005052N2□CP	2.2	100 MHz,200 mV	8	8100	0.12	400	±0.3nH
ASCH001005052N4□CP	2.4	100 MHz,200 mV	8	7700	0.15	400	±0.3nH
ASCH001005052N7□CP	2.7	100 MHz,200 mV	8	7700	0.15	400	±0.3nH
ASCH001005053N0□CP	3.0	100 MHz,200 mV	8	6300	0.15	400	±0.3nH
ASCH001005053N3□CP	3.3	100 MHz,200 mV	8	6300	0.15	400	±0.3nH
ASCH001005053N6□CP	3.6	100 MHz,200 mV	8	6100	0.15	400	±0.3nH
ASCH001005053N9□CP	3.9	100 MHz,200 mV	8	6100	0.18	400	±0.3nH
ASCH001005054N3□CP	4.3	100 MHz,200 mV	8	6000	0.18	400	±0.3nH
ASCH001005054N7□CP	4.7	100 MHz,200 mV	8	6000	0.18	400	±0.3nH
ASCH001005055N1□CP	5.1	100 MHz,200 mV	8	5300	0.20	400	±0.3nH
ASCH001005055N6□CP	5.6	100 MHz,200 mV	8	5100	0.20	400	±0.3nH
ASCH001005056N2□CP	6.2	100 MHz,200 mV	8	4500	0.22	400	±0.3nH
ASCH001005056N8□CP	6.8	100 MHz,200 mV	8	4550	0.24	400	5
ASCH001005057N5□CP	7.5	100 MHz,200 mV	8	4200	0.24	300	5
ASCH001005058N2□CP	8.2	100 MHz,200 mV	8	4100	0.24	300	5
ASCH001005059N1□CP	9.1	100 MHz,200 mV	8	3900	0.26	300	5
ASCH0010050510N□CP	10	100 MHz,200 mV	8	3900	0.26	300	5
ASCH0010050512N□CP	12	100 MHz,200 mV	8	3000	0.28	300	5
ASCH0010050515N□CP	15	100 MHz,200 mV	8	2500	0.32	300	5
ASCH0010050518N□CP	18	100 MHz,200 mV	8	2200	0.36	300	5
ASCH0010050522N□CP	22	100 MHz,200 mV	8	1900	0.42	300	5
ASCH0010050527N□CP	27	100 MHz,200 mV	8	1700	0.46	300	5

Note: When ordering, please specify tolerance code. Tolerance: C=±0.2nH / S=±0.3nH / J=±5% / K=±10%

1. Operating temperature range -55°C ~ 125°C
2. Applied the current to coils, the temperature rise shall not be more than 30°C
3. Residual impedance of short chip : 0nH
4. Measure Equipment:

L & Q: Agilent E4991A+Agilent 16197A
SRF: Agilent E4991A or HP19196C
RDC: HP4338B or CHEN HWA 502

Please be sure to request approval specifications that provide further details of the products. Kindly note that the content of these specifications are subject to change or may be discontinued without prior notice. This product may not be designed/used in medical or high risk applications without Chilisin approval. Please contact our sales department before ordering.

ASCH00100505_CP Type

■ Dimensions

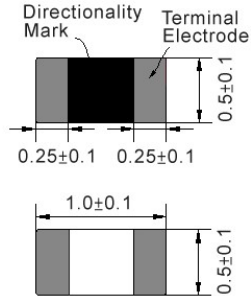

unit:mm

■ Recommended Land Pattern

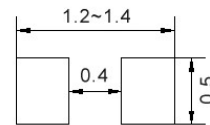

unit:mm

■ Electrical Characteristics

Part No.	Inductance	L,Q	Q	SRF	RDC	Rated Current	Tolerance
	(nH)	Test Freq.	Min.	(MHz)Min.	(Ω)Max.	(mA)Max.	(±%)
ASCH0010050533N□CP	33	100 MHz,200 mV	8	1600	0.58	200	5
ASCH0010050539N□CP	39	100 MHz,200 mV	8	1200	0.65	200	5
ASCH0010050547N□CP	47	100 MHz,200 mV	8	1000	0.72	200	5
ASCH0010050556N□CP	56	100 MHz,200 mV	8	800	0.82	200	5
ASCH0010050568N□CP	68	100 MHz,200 mV	8	800	0.92	180	5
ASCH0010050582N□CP	82	100 MHz,200 mV	8	700	1.20	150	5
ASCH00100505R10□CP	100	100 MHz,200 mV	8	900	2.00	100	5
ASCH00100505R12□CP	120	100 MHz,200 mV	8	800	2.20	100	5
ASCH00100505R15□CP	150	100 MHz,200 mV	8	700	3.50	100	5
ASCH00100505R18□CP	180	100 MHz,200 mV	8	600	3.80	100	5
ASCH00100505R22□CP	220	100 MHz,200 mV	8	500	4.20	100	5
ASCH00100505R27□CP	270	100 MHz,200 mV	8	500	4.80	100	5

Note: When ordering, please specify tolerance code. Tolerance: C=±0.2nH / S=±0.3nH / J=±5% / K=±10%

1. Operating temperature range -55°C~125°C
2. Applied the current to coils, the temperature rise shall not be more than 30°C
3. Residual impedance of short chip : 0nH
4. Measure Equipment:
L & Q: Agilent E4991A+Agilent 16197A
SRF: Agilent E4991A or HP19196C
RDC: HP4338B or CHEN HWA 502

ASCH00100505_CP Type

Characteristics Graph

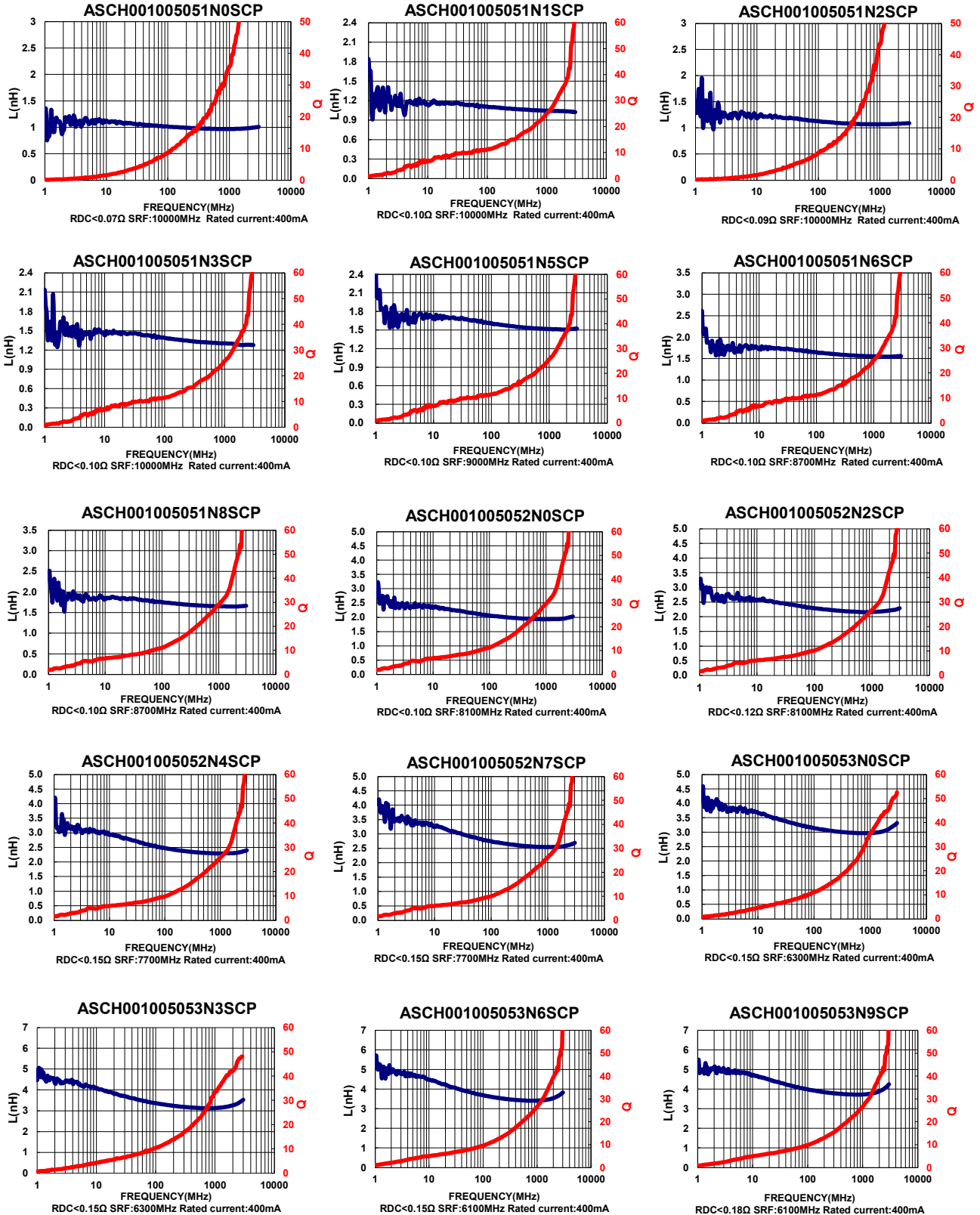

Please be sure to request approval specifications that provide further details of the products. Kindly note that the content of these specifications are subject to change or may be discontinued without prior notice. This product may not be designed/used in medical or high risk applications without Chilisin approval. Please contact our sales department before ordering.

ASCH00100505_CP Type

Characteristics Graph

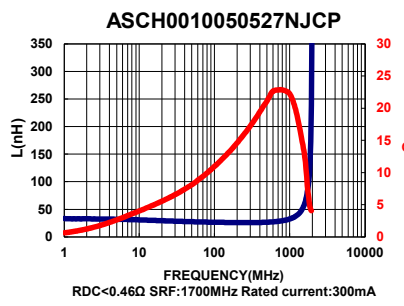
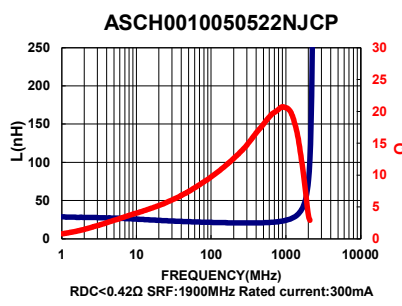
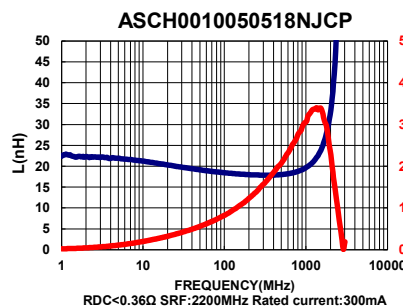
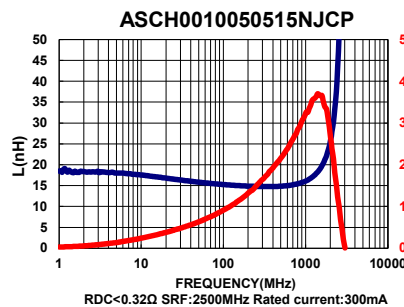
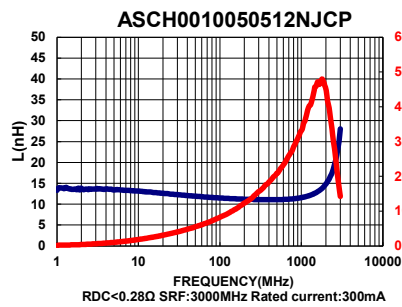
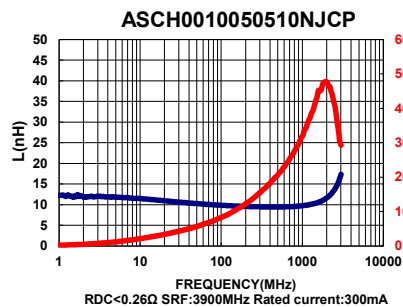
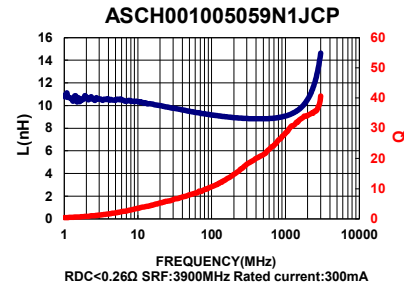
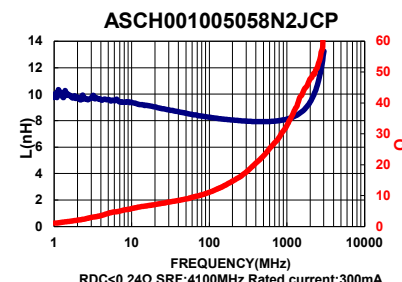
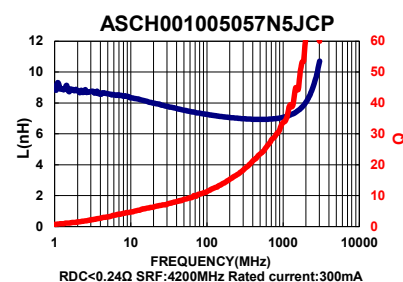
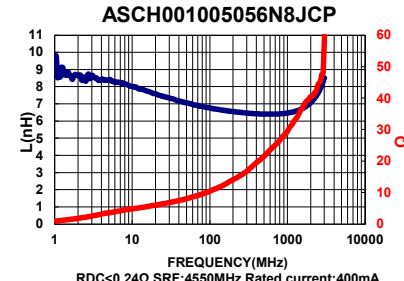
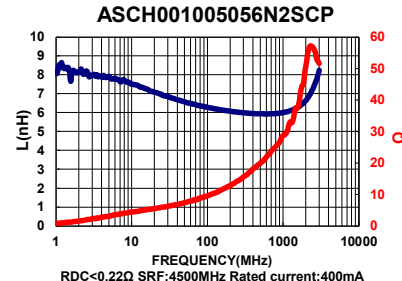
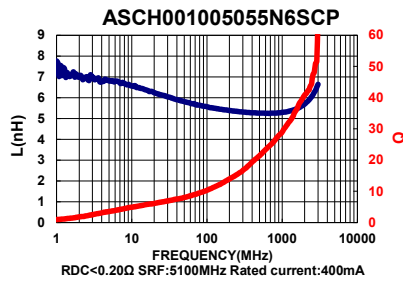
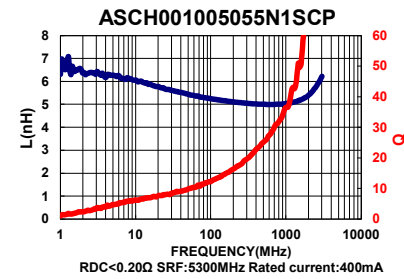
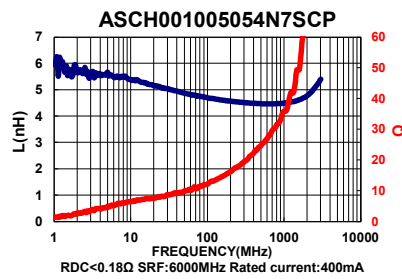
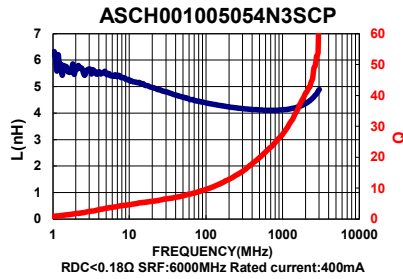

Please be sure to request approval specifications that provide further details of the products. Kindly note that the content of these specifications are subject to change or may be discontinued without prior notice. This product may not be designed/used in medical or high risk applications without Chilisin approval. Please contact our sales department before ordering.

ASCH00100505_CP Type

Characteristics Graph

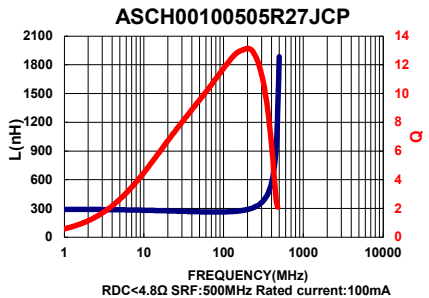
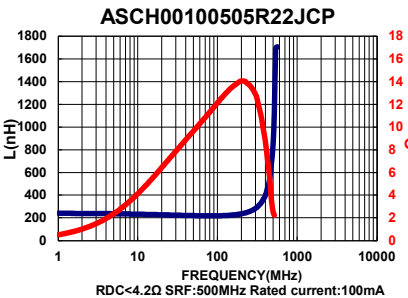
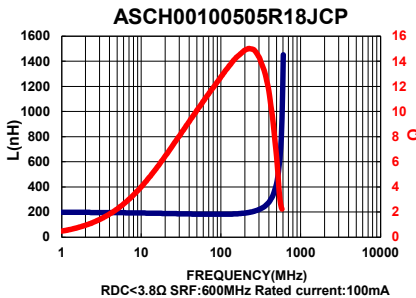
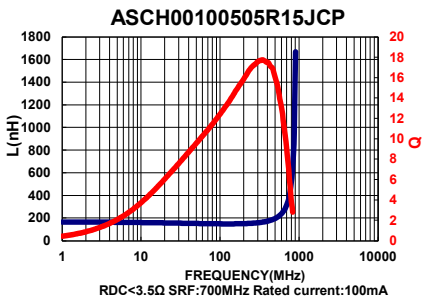
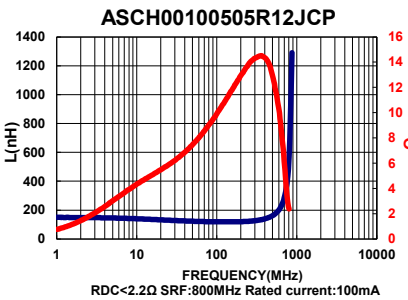
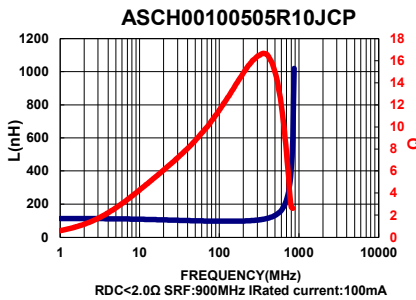
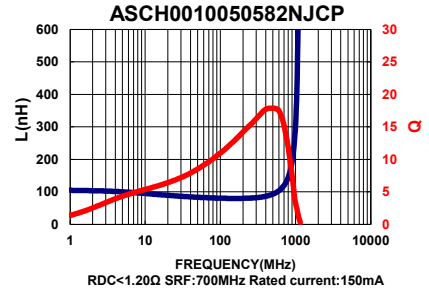
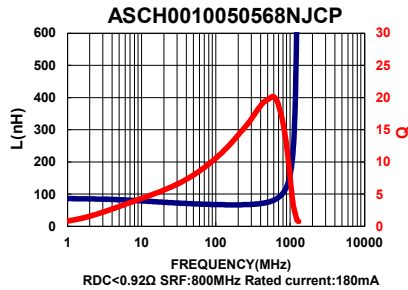
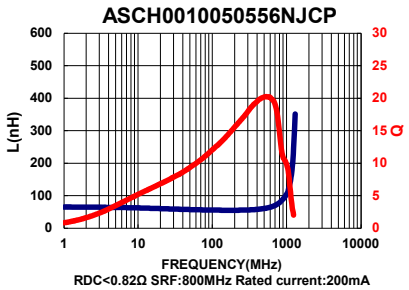
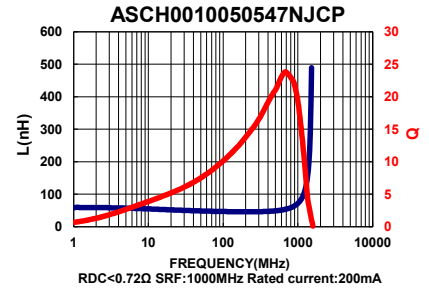
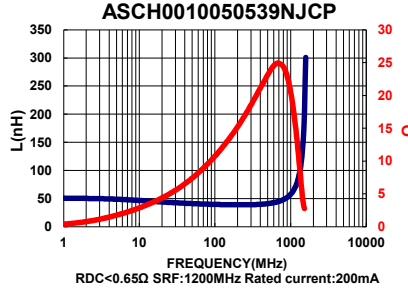
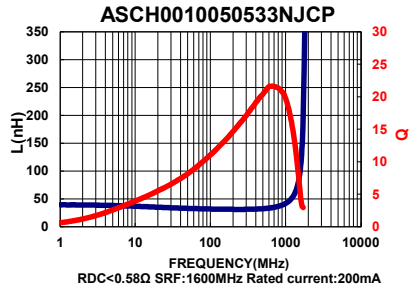

Please be sure to request approval specifications that provide further details of the products. Kindly note that the content of these specifications are subject to change or may be discontinued without prior notice. This product may not be designed/used in medical or high risk applications without Chilisin approval. Please contact our sales department before ordering.

ASCH00160808 Type

■ Dimensions

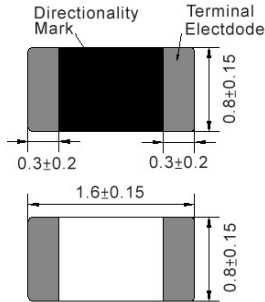

unit:mm

■ Recommended Land Pattern

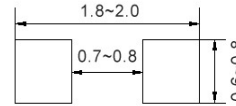

unit:mm

■ Electrical Characteristics

Part No.	Inductance	L,Q	Q	SRF	RDC	IDC	Tolerance
	(nH)	Test Freq.	Min.	(MHz)Typ.	(Ω)Max.	(mA)Max.	(±%)
ASCH001608081N0□00	1.0	100 MHz,200 mV	8	10000	0.10	600	±0.3nH
ASCH001608081N2□00	1.2	100 MHz,200 mV	8	10000	0.10	600	±0.3nH
ASCH001608081N5□00	1.5	100 MHz,200 mV	8	8000	0.10	600	±0.3nH
ASCH001608081N6□00	1.6	100 MHz,200 mV	8	8000	0.10	600	±0.3nH
ASCH001608081N8□00	1.8	100 MHz,200 mV	8	8000	0.10	600	±0.3nH
ASCH001608082N2□00	2.2	100 MHz,200 mV	8	7200	0.10	600	±0.3nH
ASCH001608082N7□00	2.7	100 MHz,200 mV	10	6200	0.10	600	±0.3nH
ASCH001608083N0□00	3.0	100 MHz,200 mV	10	5200	0.12	600	±0.3nH
ASCH001608083N3□00	3.3	100 MHz,200 mV	10	5200	0.12	600	±0.3nH
ASCH001608083N6□00	3.6	100 MHz,200 mV	10	5000	0.14	600	±0.3nH
ASCH001608083N9□00	3.9	100 MHz,200 mV	10	5000	0.14	600	±0.3nH
ASCH001608084N3□00	4.3	100 MHz,200 mV	10	4750	0.16	600	±0.3nH
ASCH001608084N7□00	4.7	100 MHz,200 mV	10	4750	0.16	600	±0.3nH
ASCH001608085N1□00	5.1	100 MHz,200 mV	10	4100	0.18	600	±0.3nH
ASCH001608085N6□00	5.6	100 MHz,200 mV	10	4100	0.18	600	±0.3nH
ASCH001608086N2□00	6.2	100 MHz,200 mV	10	3750	0.22	600	±0.3nH
ASCH001608086N8□00	6.8	100 MHz,200 mV	10	3750	0.22	600	5
ASCH001608087N5□00	7.5	100 MHz,200 mV	10	3300	0.24	600	5
ASCH001608088N2□00	8.2	100 MHz,200 mV	10	3300	0.24	600	5
ASCH0016080810N□00	10	100 MHz,200 mV	12	3000	0.26	600	5
ASCH0016080812N□00	12	100 MHz,200 mV	12	2600	0.28	600	5
ASCH0016080815N□00	15	100 MHz,200 mV	12	2500	0.32	600	5
ASCH0016080816N□00	16	100 MHz,200 mV	12	2400	0.35	600	5
ASCH0016080818N□00	18	100 MHz,200 mV	12	2400	0.35	600	5
ASCH0016080822N□00	22	100 MHz,200 mV	12	2000	0.40	500	5
ASCH0016080827N□00	27	100 MHz,200 mV	12	1900	0.45	500	5
ASCH0016080833N□00	33	100 MHz,200 mV	12	1600	0.55	400	5
ASCH0016080839N□00	39	100 MHz,200 mV	12	1400	0.60	400	5
ASCH0016080847N□00	47	100 MHz,200 mV	12	1300	0.70	400	5
ASCH0016080856N□00	56	100 MHz,200 mV	12	1100	0.75	400	5
ASCH0016080862N□00	62	100 MHz,200 mV	12	1050	0.85	400	5
ASCH0016080868N□00	68	100 MHz,200 mV	12	1050	0.85	400	5
ASCH0016080875N□00	75	100 MHz,200 mV	12	900	1.00	300	5
ASCH0016080882N□00	82	100 MHz,200 mV	12	900	1.00	300	5

Note: When ordering, please specify tolerance code. Tolerance: S=±0.3nH / J=±5%

1. Operating temperature range -55°C ~125°C
2. Applied the current to coils, the inductance shall be less than 10% initial value
3. Residual impedance of short chip : 0nH
4. Measure Equipment:

Please be sure to request approval specifications that provide further details of the products. Kindly note that the content of these specifications are subject to change or may be discontinued without prior notice. This product may not be designed/used in medical or high risk applications without Chilisin approval. Please contact our sales department before ordering.

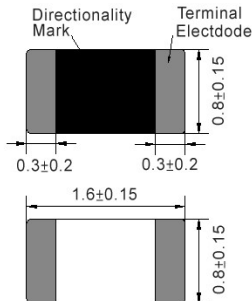
ASCH00160808 Type
■ Dimensions

unit:mm

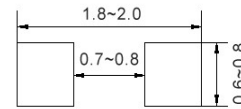
■ Recommended Land Pattern

unit:mm

■ Electrical Characteristics

Part No.	Inductance	L,Q	Q	SRF	RDC	IDC	Tolerance
	(nH)	Test Freq.	Min.	(MHz)Typ.	(Ω)Max.	(mA)Max.	(±%)
ASCH00160808R10□00	100	100 MHz,200 mV	12	770	1.20	300	5
ASCH00160808R12□00	120	50 MHz,200 mV	8	650	1.30	300	5
ASCH00160808R15□00	150	50 MHz,200 mV	8	550	1.70	250	5
ASCH00160808R18□00	180	50 MHz,200 mV	8	520	1.90	250	5
ASCH00160808R22□00	220	50 MHz,200 mV	8	500	2.00	250	5
ASCH00160808R27□00	270	50 MHz,200 mV	8	470	2.20	150	5
ASCH00160808R33□00	330	50 MHz,200 mV	8	320	2.80	100	5
ASCH00160808R39□00	390	50 MHz,200 mV	8	300	3.00	100	5

Note: When ordering, please specify tolerance code. Tolerance: S=±0.3nH / J=±5%

1. Operating temperature range -55°C ~ 125°C
2. Applied the current to coils, the inductance shall be less than 10% initial value
3. Residual impedance of short chip : 0nH
4. Measure Equipment:
 L & Q: Agilent E4991A+Agilent 16197A
 SRF: Agilent E4991A or HP19196C
 RDC: HP4338B or CHEN HWA 502

ASCH00160808 Type

Characteristics Graph

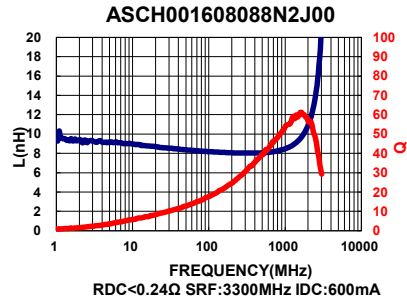
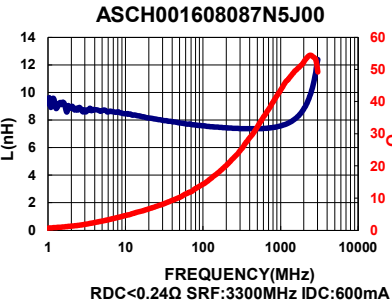
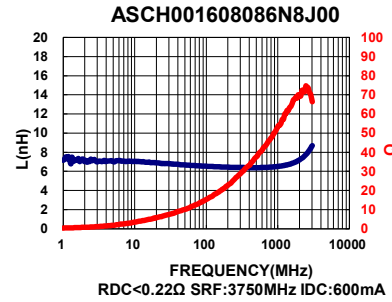
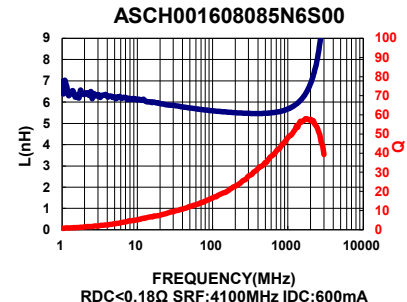
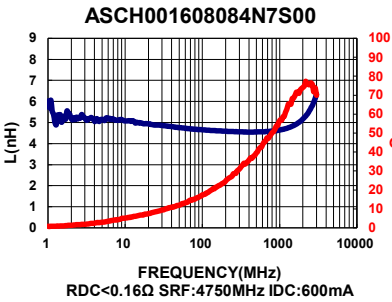
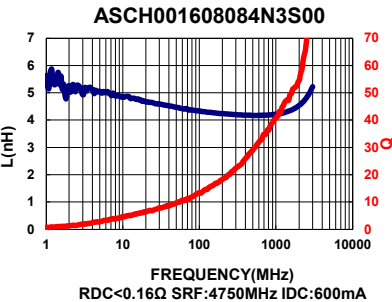
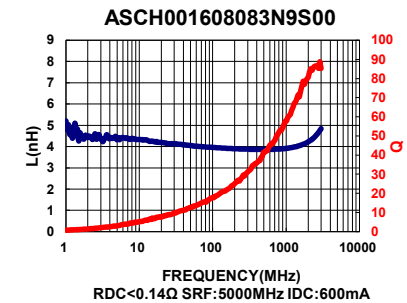
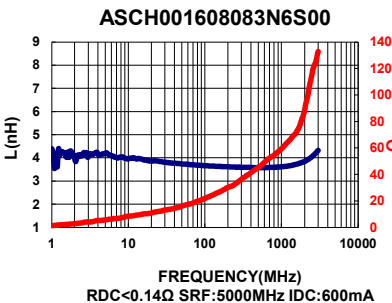
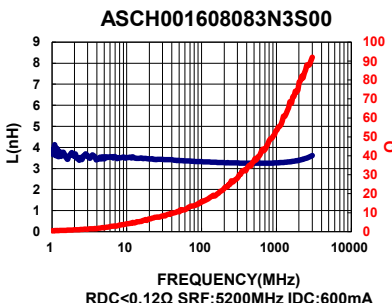
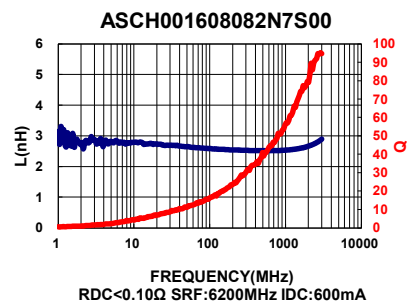
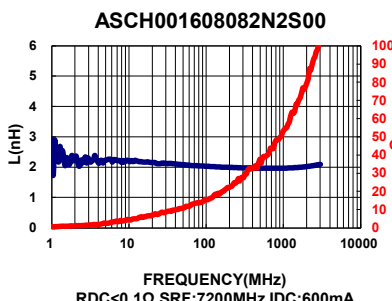
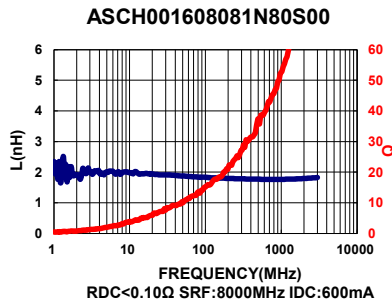
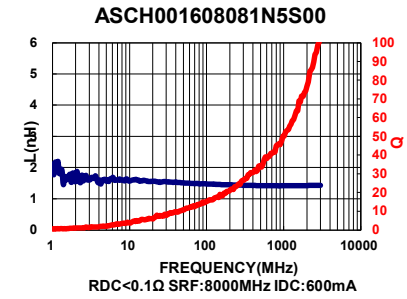
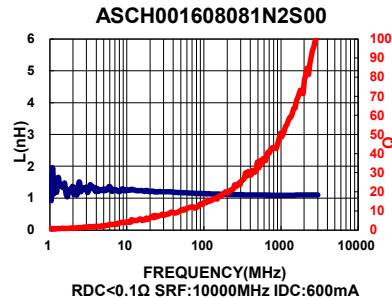
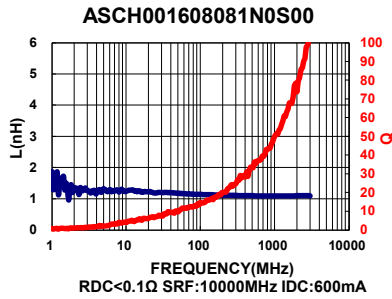

Please be sure to request approval specifications that provide further details of the products. Kindly note that the content of these specifications are subject to change or may be discontinued without prior notice. This product may not be designed/used in medical or high risk applications without Chilisin approval. Please contact our sales department before ordering.

ASCH00160808 Type

Characteristics Graph

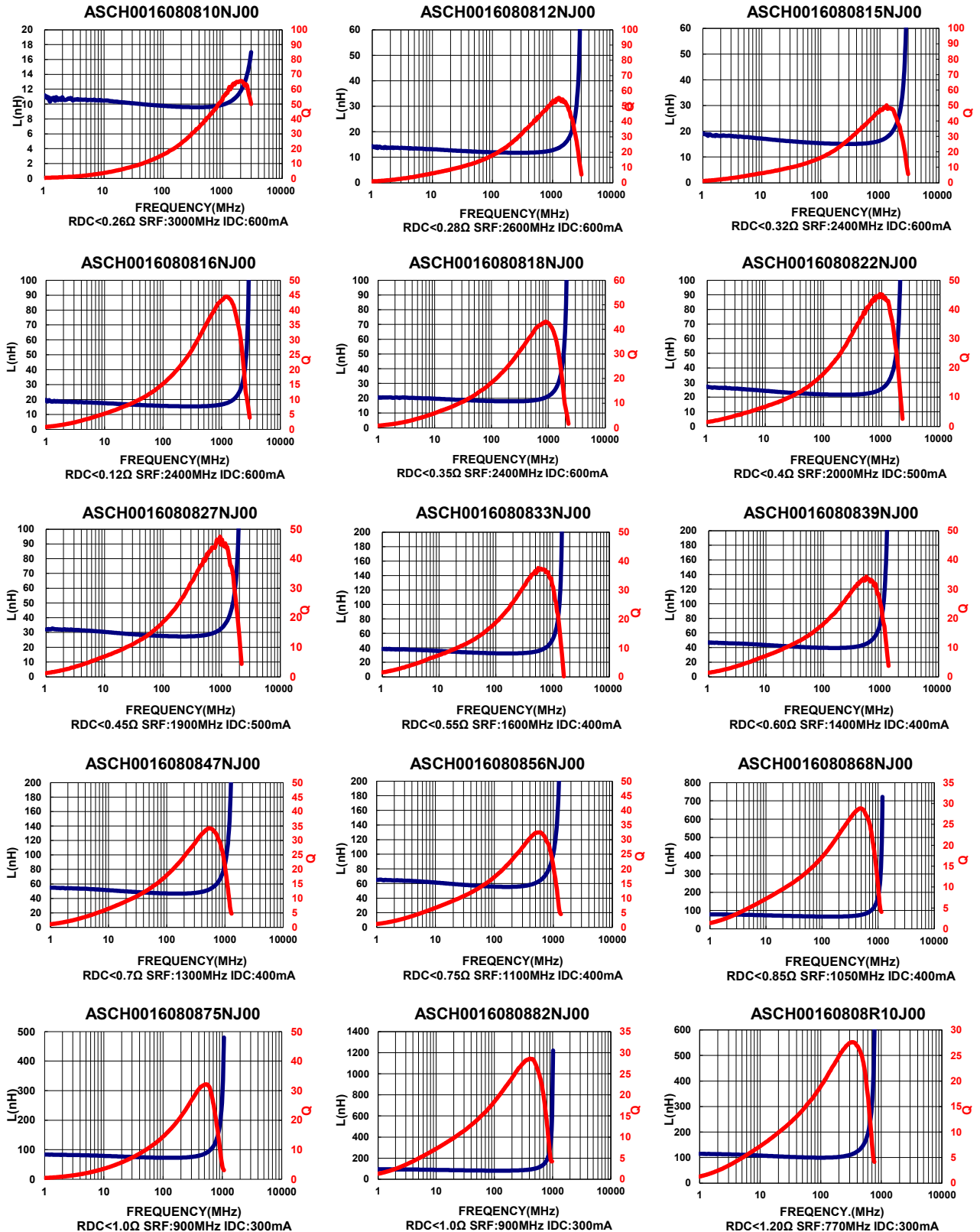

Please be sure to request approval specifications that provide further details of the products. Kindly note that the content of these specifications are subject to change or may be discontinued without prior notice. This product may not be designed/used in medical or high risk applications without Chilisin approval. Please contact our sales department before ordering.

ASCH00160808 Type

Characteristics Graph

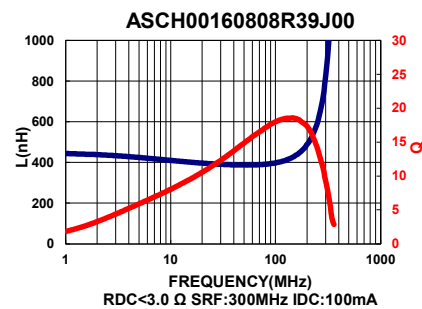
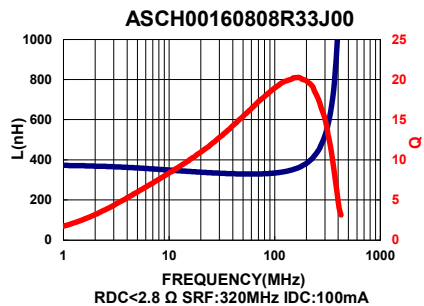
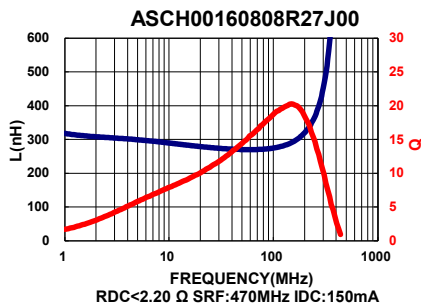
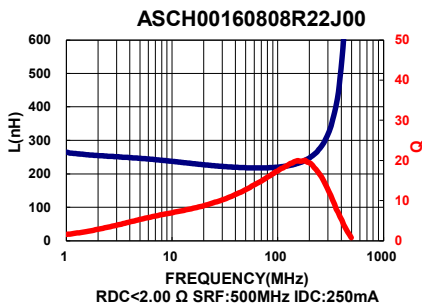
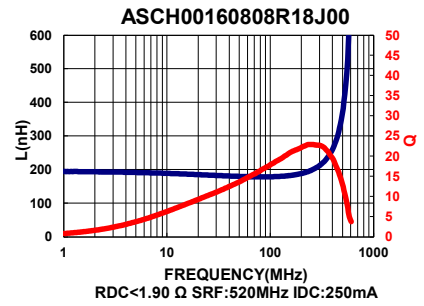
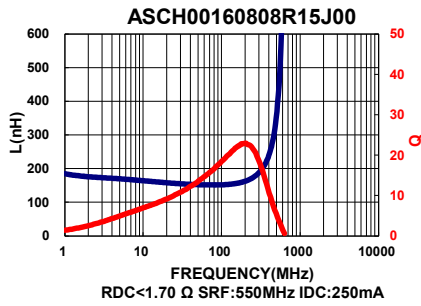
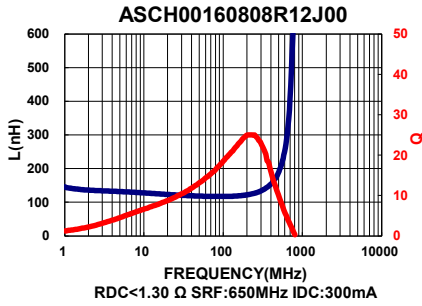

Please be sure to request approval specifications that provide further details of the products. Kindly note that the content of these specifications are subject to change or may be discontinued without prior notice. This product may not be designed/used in medical or high risk applications without Chilisin approval. Please contact our sales department before ordering.

■ Packaging

Tape Dimensions

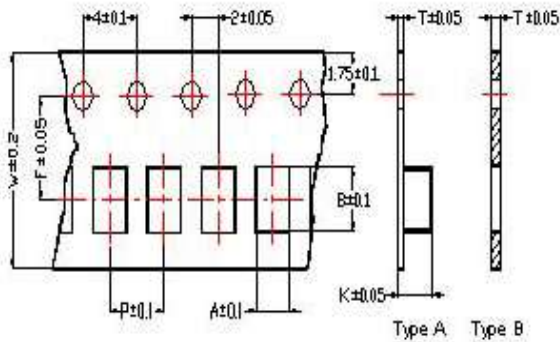

Tape Material

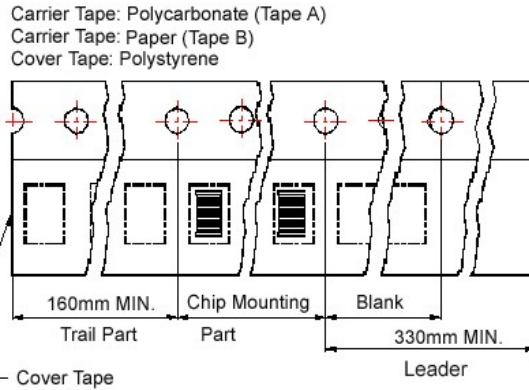

Reel Dimensions

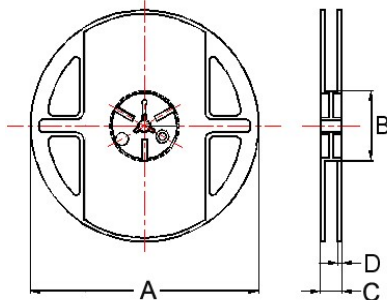

Dimensions in mm

TYPE	Tape Dimensions							Reel Dimensions				Quantity PCS / Reel
	A	B	T	W	P	F	Tape	A	B	C	D	
ASCH00100505	0.62	1.12	0.60	8	2	3.5	B	178	60	12	1.5	10000
ASCH00160808	1.00	1.80	0.95	8	4	3.5	B	178	60	12	1.5	4000

Please be sure to request approval specifications that provide further details of the products. Kindly note that the content of these specifications are subject to change or may be discontinued without prior notice. This product may not be designed/used in medical or high risk applications without Chilisin approval. Please contact our sales department before ordering.

单击下面可查看定价，库存，交付和生命周期等信息

[>>CHILISIN\(奇力新\)](#)