

**VOLTAGE RANGE: 40 - 200V**

**CURRENT: 10 A**

### Features

- High efficiency operation
- Low power loss
- Low stored charge majority carrier conduction
- High forward surge capability
- Lead free in compliance with EU RoHS 2011/65/EU directive
- Green molding compound as per IEC61249 Std..(Halogen Free)

### Mechanical Data

- Circuit figure: Common cathode
- Leads: Solderable per mil-std-202, Method 208
- Polarity: as marked
- Mounting torque: 5 in-lbs maximum
- Terminals: Puretin plated
- Weight: TO-220AB 1.85 grams

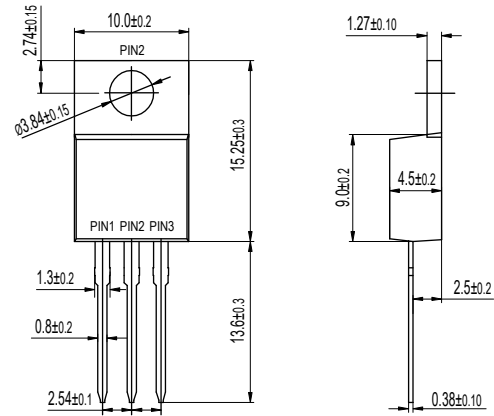
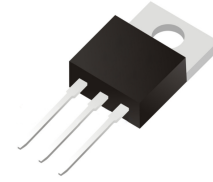

TO-220AB

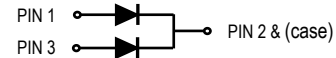

### Maximum Ratings and Electrical Characteristics $T_A = 25^\circ\text{C}$ unless otherwise specified

RATINGS	SYMBOL	MBR 1040CT	MBR 1045CT	MBR 1060CT	MBR 10100CT	MBR 10150CT	MBR 10200CT	UNIT	
Maximum repetitive reverse voltage	VRRM	40	45	60	100	150	200	V	
Maximum RMS voltage	VRMS	28	32	42	70	105	140	V	
Maximum DC blocking voltage	VDC	40	45	60	100	150	200	V	
Maximum average forward current per device per diode	I <sub>AV</sub>	10							A
		5							
Peak forward surge current, 8.3ms single half sine-wave superimposed on rated load	I <sub>FSM</sub>	125							A
Typical thermal resistance (Note 1)	R <sub>θ-JC</sub>	2.0							°C/W
Operating junction temperature range	T <sub>J</sub>	-55 to +150				-55 to +175		°C	
Storage temperature range	T <sub>STG</sub>	-55 to +175						°C	
Maximum forward voltage per leg at I <sub>F</sub> =5A	V <sub>F</sub>	0.65		0.75	0.85		0.92	V	
Maximum average reverse current at rated DC blocking voltage $T_J=25^\circ\text{C}$ $T_J=125^\circ\text{C}$	I <sub>R</sub>		0.10				0.01	mA	
			15				5		

Notes: 1. Thermal resistance from junction to case.

FIG. 1 - TYPICAL FORWARD CURRENT DERATING CURVE

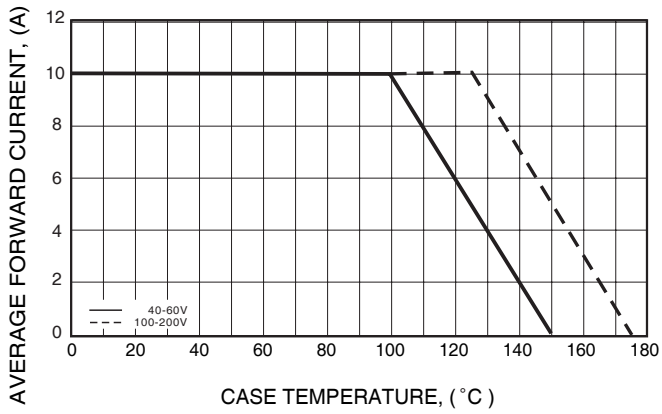

FIG. 2 - MAXIMUM NON-REPETITIVE FORWARD SURGE CURRENT

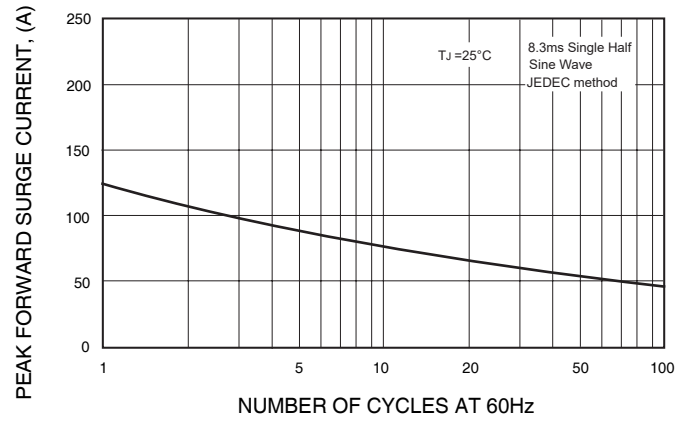

FIG. 3 - TYPICAL REVERSE CHARACTERISTICS

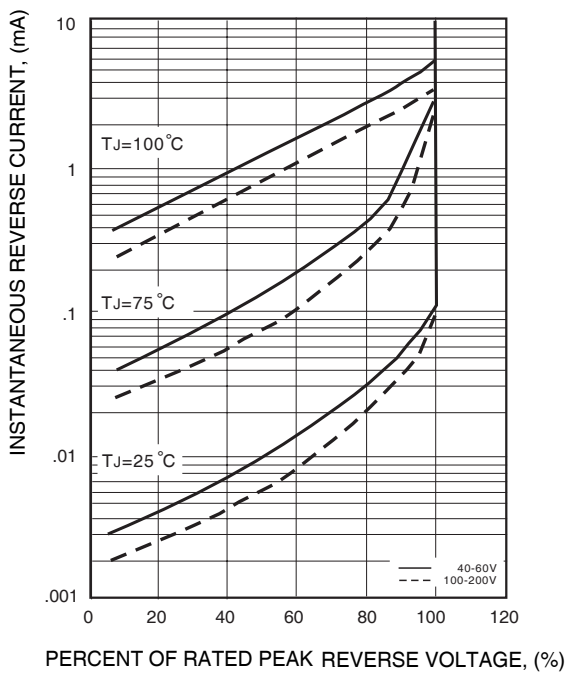
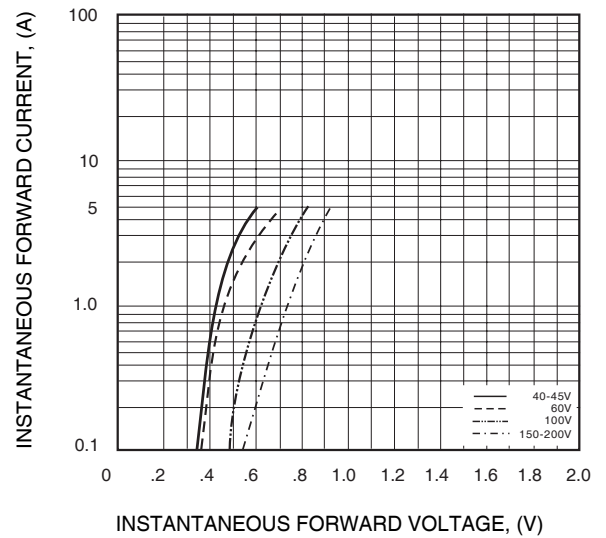

FIG. 4 - TYPICAL INSTANTANEOUS FORWARD CHARACTERISTICS



单击下面可查看定价，库存，交付和生命周期等信息

[>>SUNMATE\(森美特\)](#)