

GT25C08A



GT25C08A

Automotive 8-Kbit SPI Bus EEPROM

Copyright © 2014 Giantec Semiconductor Corp. (Giantec). All rights reserved. Giantec reserves the right to make changes to this specification and its products at any time without notice. Giantec products are not designed, intended, authorized or warranted for use as components in systems or equipment intended for critical medical or surgical equipment, aerospace or military, or other applications planned to support or sustain life. It is the customer's obligation to optimize the design in their own products for the best performance and optimization on the functionality and etc. Giantec assumes no liability arising out of the application or use of any information, products or services described herein. Customers are advised to obtain the latest version of this device specification before relying on any published information and prior placing orders for products.

Giantec Semiconductor Corp

www.giantec-semi.com

1/27



GT25C08A

Table of Contents

1. Features	4
2. General Description	4
3. Functional Block Diagram	5
4. Pin Configuration	6
4.1 8-Pin SOIC, TSSOP	6
4.2 8-Lead UDFN	6
4.3 Pin Definition	6
4.4 Pin Descriptions	6
5. Device Operation	8
5.1 Status Register	8
5.2 Op-Code Instructions	9
5.3 Write Enable	10
5.4 Write Disable	10
5.5 Read Status Register	10
5.6 Write Status Register	11
5.7 Read Data	11
5.8 Write Data	12
5.9 Identification Page	12
5.10 Delivery State	15
6. Application Recommendation	16
6.1 Operating Supply Voltage	16
6.2 Power-up conditions	16
6.3 Power-down	16
6.4 ECC (Error Correction Code) and Write cycling	16
7. Electrical Characteristics	17
7.1 Absolute Maximum Ratings	17
7.2 Operating Range	17
7.3 Capacitance	17
7.4 Reliability	17
7.5 Power Up/Down and Voltage Drop	18
7.6 DC Electrical Characteristic	19
7.7 AC Electrical Characteristic	20
7.8 Timing Diagrams	21
8. Ordering Information	22
9. Top Markings	23
9.1 SOIC Package	23
9.2 TSSOP Package	23
9.3 UDFN Package	23
10. Package Information	24



GT25C08A

10.1 SOP	24
10.2 TSSOP	25
10.3 UDFN	26



GT25C08A

1. Features

- Serial Peripheral Interface (SPI) Compatible
 - Supports Mode 0 (0,0) and Mode 3 (1,1)
- Wide-voltage Operation
 - $V_{CC} = 1.7V$ to $5.5V$
- Operating Frequency:
 - 20 MHz for $V_{CC} \geq 4.5V$
 - 10 MHz for $V_{CC} \geq 2.5V$
 - 5 MHz for $V_{CC} \geq 1.7V$
- Low power CMOS:
 - Standby current (max.): $12 \mu A$, $5.5V$
 - Operating current (max.): 6 mA, $5.5V$
- Memory organization: 8Kb (1,024 x 8)
- Page Size: 32 bytes
- Byte and Page write mode
 - Partial page writes allowed
 - Addition write lockable page (Identification Page)
- Block Write Protection
 - Protect Entire Array
- Self-timed write cycle: 4 ms (max.)
- Endurance:
 - 4 million Write cycles at $25^{\circ}C$
 - 1.2 million Write cycles at $85^{\circ}C$
 - 600 k Write cycles at $125^{\circ}C$
- Data retention
 - 50 years at $125^{\circ}C$
 - 100 years at $25^{\circ}C$
- Compliant with AEC-Q100 grade 1
- Packages: SOIC, TSSOP and UDFN
- ESD Protection: $\pm 8000V$
- Lead-free, RoHS, Halogen free, Green
- Noise immunity on inputs, besides Schmitt trigger

2. General Description

The GT25C08A is an 8-Kbit serial EEPROM Automotive grade device operating up to $125^{\circ}C$, which is compliant with the very high level of reliability defined by the automotive standard AEC-Q100 grade 1. The GT25C08A utilizes standard Serial Peripheral Interface (SPI) for communications and contains a memory array of 8Kb (1,024 x 8), which is organized in 32 bytes per page.

The EEPROM operates in a wide voltage range from $1.7V$ to $5.5V$ running up to 20MHz, which fits most application. The product provides low-power operations and low standby current. The device is offered in Lead-free, RoHS, halogen free or Green package. The available package types are 8-pin SOIC, TSSOP and UDFN.

This product has a compatible SPI interface: Chip-Select (\overline{CS}), Serial Data In (SI), Serial Data Out (SO) and Serial Clock (SCK) for high-speed communication. Furthermore, a Hold feature via \overline{HOLD} pin allows the device entering into a suspended state whenever necessary and resuming the communication without re-initializing the serial sequence. A Status Register facilitates a flexible write protection mechanism and device status monitoring.

In order to refrain the state machine from entering into a wrong state during power-up sequence or a power toggle off-on condition, a power on reset circuit is implemented. During power-up, the device does not respond to any instructions until the supply voltage (V_{CC}) has reached an acceptable stable level above the reset threshold voltage. Once V_{CC} passes the power on reset threshold, the device is reset and enters into the Standby mode. This should also avoid any inadvertent Write operations during power-up stage. During power-down process, the device will enter into standby mode, once V_{CC} drops below the power on reset threshold voltage. In addition, the device will be in standby mode after receiving the Stop command, provided that no internal write operation is in progress. Nevertheless, it is illegal to send a command unless the V_{CC} is within its operating level.

This product optionally offers an additional page (Identification Page) of 32 bytes. The Identification Page can be used to store sensitive application parameters which can be (later) permanently locked in Read-only mode.



GT25C08A

3. Functional Block Diagram

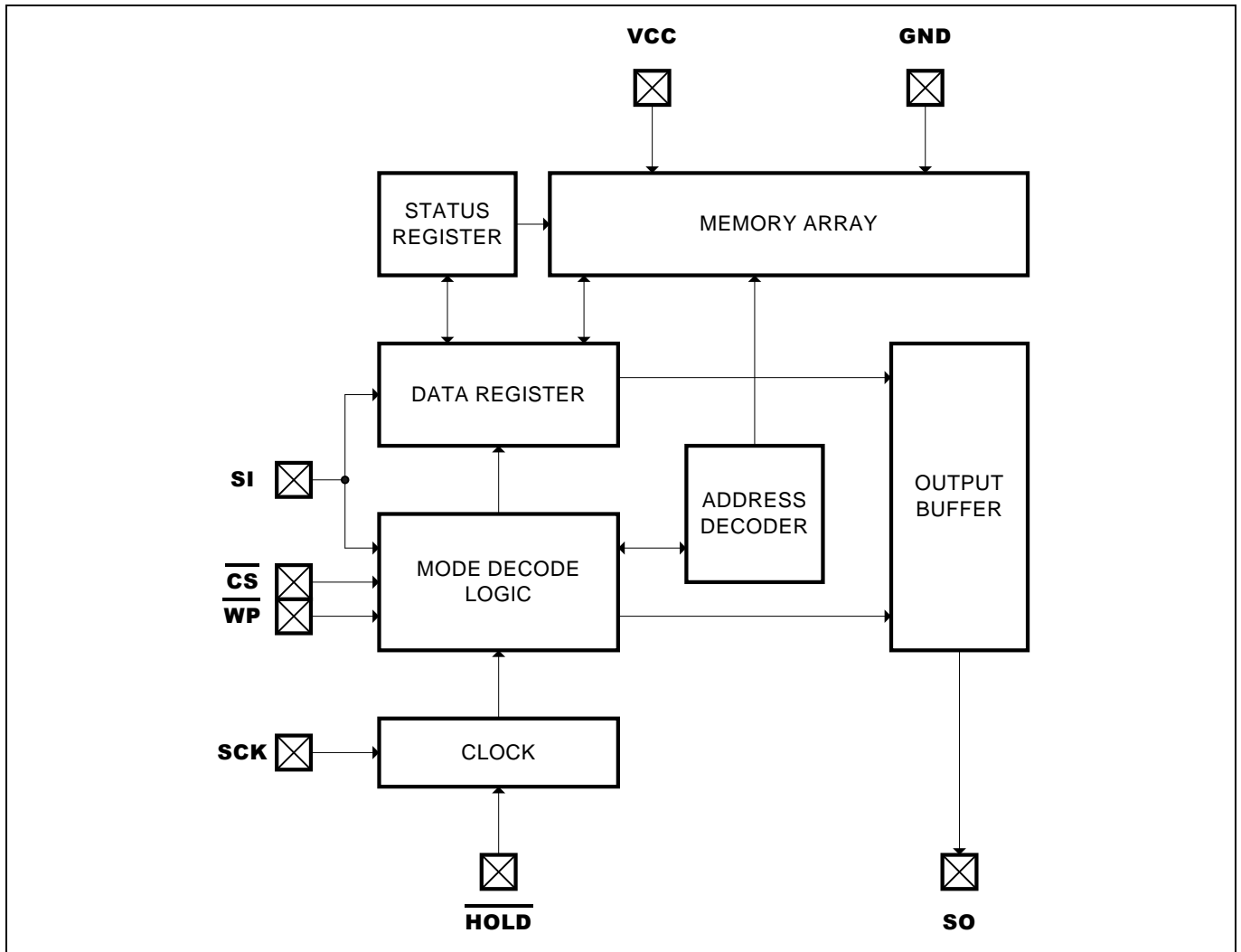

Serial Interface Description

Master:	The device that provides a clock signal.
Slave:	GT25C08A.
Transmitter/Receiver:	The GT25C08A has both data input (SI) and data output (SO).
MSB	MSB (Most Significant Bit) is the first bit being transmitted or received.
Op-Code:	Operational instruction code typically sent to the GT25C08A is the first byte of information transmitted after $\overline{\text{CS}}$ is Low. If the Op-Code is a valid instruction as listed in Table 5.4, then it will be decoded appropriately. It is prohibited to send an invalid Op-Code.



GT25C08A

4. Pin Configuration

4.1 8-Pin SOIC, TSSOP

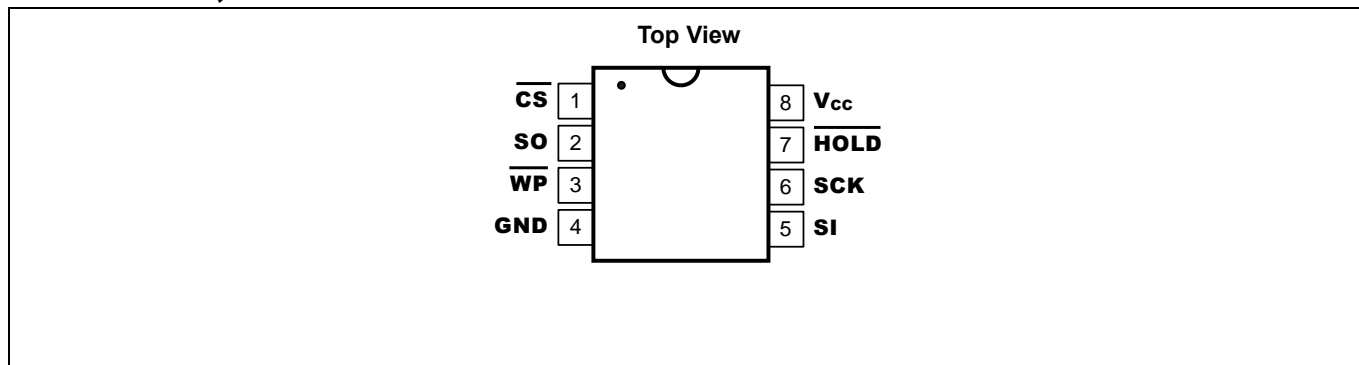

4.2 8-Lead UDFN

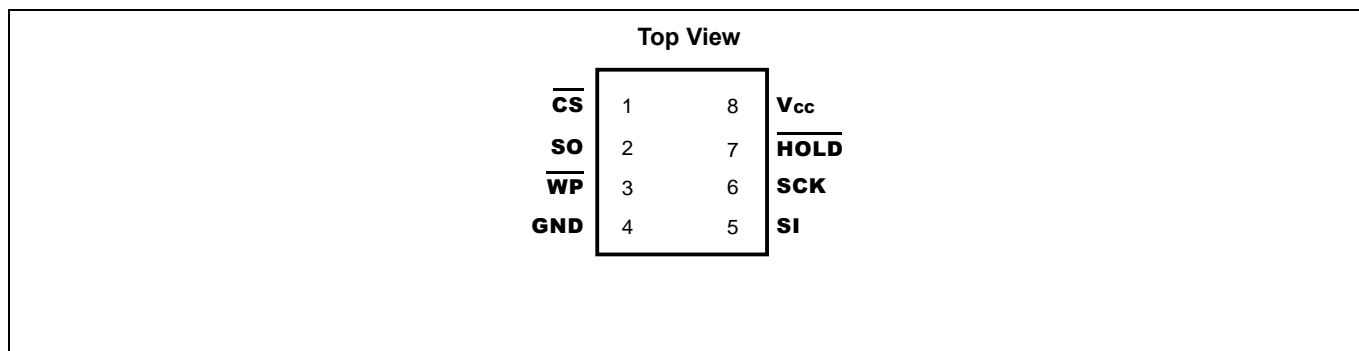

4.3 Pin Definition

Pin No.	Pin Name	I/O	Definition
1	$\overline{\text{CS}}$	I	Chip Select
2	SO	O	Serial Data Output
3	$\overline{\text{WP}}$	I	Write Protect Input
4	GND	-	Ground
5	SI	I	Serial Data Input
6	SCK	I	Serial Clock
7	HOLD	I	Hold function
8	V_{cc}	-	Supply Voltage

4.4 Pin Descriptions

Chip Select ($\overline{\text{CS}}$)

The $\overline{\text{CS}}$ pin is used to enable or disable the device. Upon power-up, $\overline{\text{CS}}$ must follow the supply voltage. When the device is ready



GT25C08A

for instruction input, this signal requires a High-to-Low transition. Once \overline{CS} is stable at Low, the device is enabled. Then the master and slave can communicate among each other through SCK, SI, and SO pins. Upon completion of transmission, \overline{CS} must be driven to High in order to stop the operation or start the internal write operation. The device will enter into standby mode, unless an internal write operation is in progress. During this mode, SO becomes high impedance.

Serial Clock (SCK)

Under the SPI modes (0, 0) and (1, 1), this clock signal provides synchronization between the master and GT25C08A. Typically, Op-Codes, addresses and data are latched from SI at the rising edge of SCK, while data from SO are clocked out at the falling edge of SCK.

Serial Data Input (SI)

Data Input pin.

Serial Data Output (SO)

Data output pin.

Write Protect (\overline{WP})

This active Low input signal is utilized to initiate Hardware Write Protection mode. This mode prevents the Block Protection bits and the WPEN bit in the Status Register from being modified. To activate the Hardware Write Protection, \overline{WP} must be Low simultaneously when WPEN is set to 1.

Hold (\overline{HOLD})

This feature is used to suspend the device in the middle of a serial sequence and temporarily ignore further communication on the bus (SI, SO, SCK). The \overline{HOLD} signal transitions must occur only when SCK is Low and be held stable during SCK transitions. Connecting \overline{HOLD} to High disables this feature.

Note:

More detail application information, please check application note.

Application note :<http://www.giantec-semi.com/Application-note.html>



5. Device Operation

5.1 Status Register

The Status Register accessible by the user consists of 8-bits data for write protection control and write status. It becomes Read-Only under any of the following conditions: Hardware Write Protection is enabled or WEN is set to 0. If neither is true, it can be modified by a valid instruction.

Table 5.1: Status Register

Bit	Symbol	Name	Description
0	$\overline{\text{RDY}}$	Ready	When $\overline{\text{RDY}} = 0$, device is ready for an instruction. When $\overline{\text{RDY}} = 1$, device is busy. As busy, device only accepts Read Status Register command.
1	WEN	Write Enable	This represents the write protection status of the device. When WEN = 0, Status Register and entire array cannot be modified, regardless the setting of WPEN, $\overline{\text{WP}}$ pin or block protection. Write Enable command (WREN) can be used to set WEN to 1. Upon power-up stage, WEN is reset to 0.
2	BP0	Block Protect Bit	Despite of the status on WPEN, $\overline{\text{WP}}$ or WEN, BP0 and BP1 configure any combinations of the four blocks being protected (Table 5.2). They are non-volatile memory and programmed to 0 by factory.
3	BP1	Block Protect Bit	
4	X	Don't Care	Values can be either 0 or 1, but are not retained. Mostly always 0, except during write operation.
5	X	Don't Care	
6	X	Don't Care	
7	WPEN	Write Protect Enable	This bit can be utilized to enable Hardware Write Protection, together with $\overline{\text{WP}}$ pin. If enabled, Status Register becomes read-only. However, the memory array is not protected by this mode. Hardware Write Protection requires the setting of $\overline{\text{WP}} = 0$ and WPEN = 1. Otherwise, it is disabled. WPEN cannot be altered from 1 to 0 if $\overline{\text{WP}}$ is already set to Low. (Table 5.3 for write protection)

Note: During internal write cycles, bits 0 to 7 are temporarily 1's.

Table 5.2: Block Protection by BP0 and BP1

Level	Status Register Bits		Array Addresses Protected
	BP1	BP0	
0	0	0	None
1	0	1	None
2	1	0	None
3 (All)	1	1	0000h-03FFh



Table 5.3: Write Protection

WPEN	\overline{WP}	Hardware Write Protection	WEN	Inside Block	Outside Block	Status Register (WPEN, BP1, BP0)
0	X	Not Enabled	0	Read-only	Read-only	Read-only
0	X	Not Enabled	1	Read-only	Unprotected	Unprotected
1	0	Enabled	0	Read-only	Read-only	Read-only
1	0	Enabled	1	Read-only	Unprotected	Read-only
X	1	Not Enabled	0	Read-only	Read-only	Read-only
X	1	Not Enabled	1	Read-only	Unprotected	Unprotected

Note: X = Don't care bit.

5.2 Op-Code Instructions

The operations of the GT25C08A are controlled by a set of instruction Op-Codes (Table 5.4) that are clocked-in serially via SI pin. To initiate an instruction, the chip select (\overline{CS}) must be Low. Subsequently, each Low-to-High transition of the clock (SCK) will latch a stable level from SI. After the 8-bit Op-Code, it may continue to latch-in an address and/or data from SI accordingly, or to output data from SO. During data output, data are latched out at the falling edge of SCK. All communications start with MSB first. Upon the transmission of the last bit but prior to any following Low-to-High transition on SCK, \overline{CS} must be brought to High in order to end the transaction and start the operation. The device will enter into Standby Mode after the operation is completed.

Table 5.4: Instruction Op-Codes ^[1,2,3]

Name	Op-Code	Operation	Address	Data (SI)	Data (SO)
WREN	0000 X110	Set Write Enable Latch	-	-	-
WRDI	0000 X100	Reset Write Enable Latch	-	-	-
RDSR	0000 X101	Read Status Register	-	-	D ₇ -D ₀ -
WRSR	0000 X001	Write Status Register	-	D ₇ -D ₀	-
READ	0000 X011	Read Data from Array	A ₁₂ -A ₀	-	D ₇ -D ₀ , ...
WRITE	0000 X010	Write Data to Array	A ₁₂ -A ₀	D ₇ -D ₀ , ...	-
RDID	1000 X011	Read Identification Page	A ₄ -A ₀	-	D ₇ -D ₀
WRID	1000 X010	Write Identification Page	A ₄ -A ₀	D ₇ -D ₀	-
RDLS	1000 X011	Read the Identification Page Lock Status	-	-	-
LID	1000 X010	Lock the Identification Page	-	-	-

Notes: ^[1] X = Don't care bit. However, it is recommended to be "0".

^[2] Some address bits may be don't care (Table 5.5).

^[3] It is strongly recommended that an appropriate format of Op-Code must be entered. Otherwise, it may cause unexpected phenomenon to be occurred. Nevertheless, it is illegal to input invalid any Op-Code.

Table 5.5: Address Key

Instructions	MSB Address Byte								LSB Address Byte							
	b15	b14	b13	b12	b11	b10	b9	b8	b7	b6	b5	b4	b3	b2	b1	b0
WRITE or READ	x	x	X	A12	A11	A10	A9	A8	A7	A6	A5	A4	A3	A2	A1	A0
WRID or RDID	x	x	x	x	x	0	x	x	x	x	x	A4	A3	A2	A1	A0



GT25C08A

LID or RDLS	x	x	x	x	x	1	x	x	x	x	x	x	x	x	x	x
-------------	---	---	---	---	---	---	---	---	---	---	---	---	---	---	---	---

Note: 'x' is don't care

5.3 Write Enable

When V_{CC} is initially applied, the device powers up with both status register and entire array in a write-disabled state. Upon completion of Write Disable (WRDI), Write Status Register (WRSR) or Write Data to Array (WRITE), the device resets the WEN bit in the Status Register to 0. Prior to any data modification, a Write Enable (WREN) instruction is necessary to set WEN to 1 (Figure. 5-1).

Figure 5-1. WREN Sequence

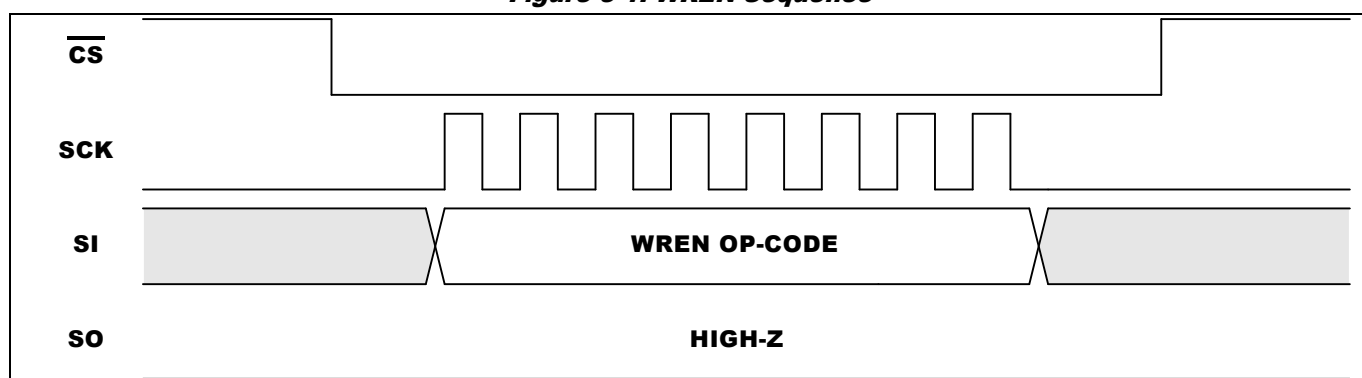

5.4 Write Disable

The device can be completely protected from modification by resetting WEN to 0 through the Write Disable (WRDI) instruction (Figure. 5-2).

Figure 5-2. WRDI Sequence

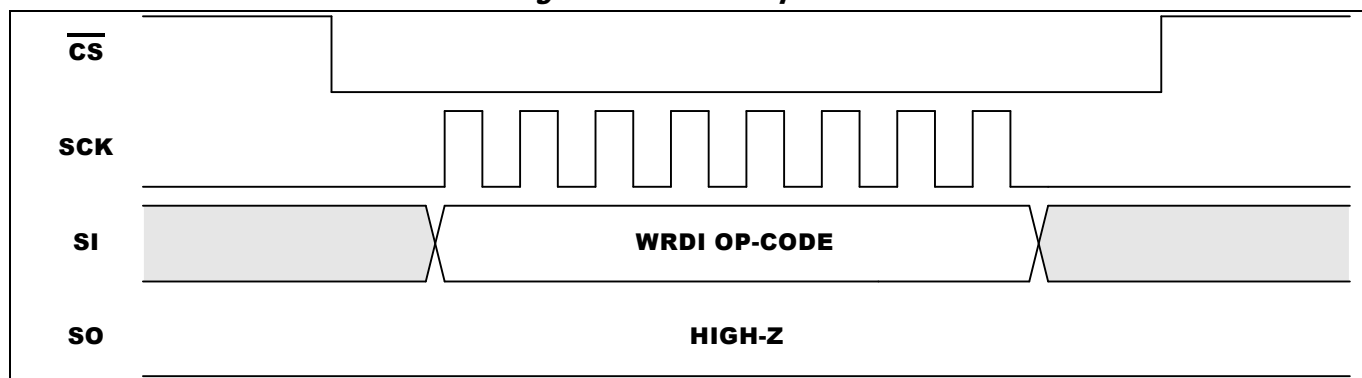

5.5 Read Status Register

The Read Status (RDSR) instruction reviews the status of Write Protect Enable, Block Protection setting (Table 5.2), Write Enable state and \overline{RDY} status. RDSR is the only instruction accepted when a write cycle is underway. It is recommended that the status of Write Enable and \overline{RDY} be checked, especially prior to an attempted modification of data. These 8 bits information can be repeatedly output on SO after the initial Op-Code (Figure. 5-3).

Figure 5-3. RDSR Sequence



GT25C08A

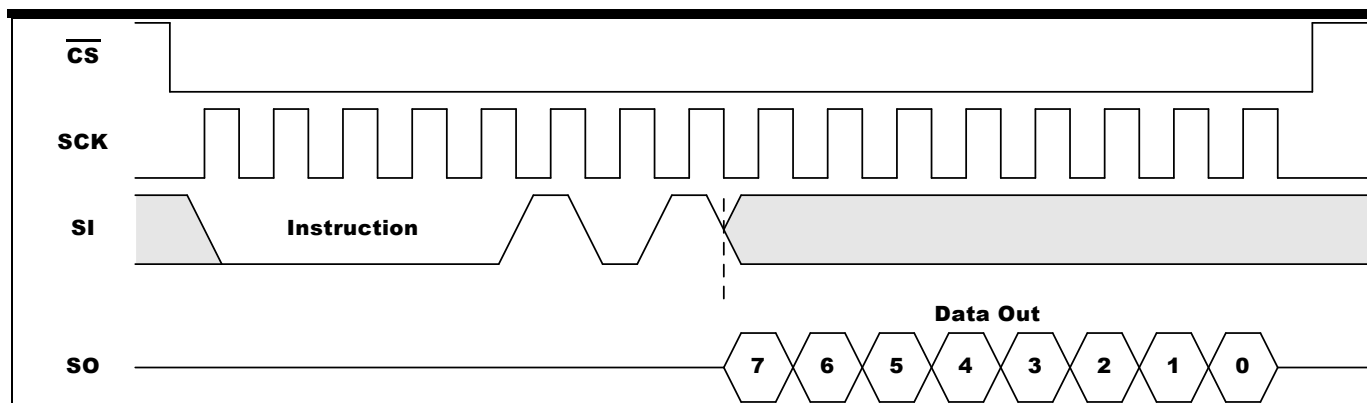

5.6 Write Status Register

The Write Status Register (WRSR) instruction allows the user to choose a Block Protection setting and set or reset the WPEN bit. The values of the other data bits incorporated into WRSR can be 0 or 1 and are not stored in the Status Register. WRSR will be ignored unless both following conditions are true: a) WEN = 1, due to a prior WREN instruction; and b) Hardware Write Protection is not enabled (Table 5.3). Except for $\overline{\text{RDY}}$ status, the values in the Status Register remain unchanged until the moment when the write cycle is completed and the register is updated. Note that WPEN can be changed from 1 to 0 only if $\overline{\text{WP}}$ is already set High. Once completed, WEN is reset for complete chip write protection (Fig. 5-4).

Figure 5-4. WRSR Sequence

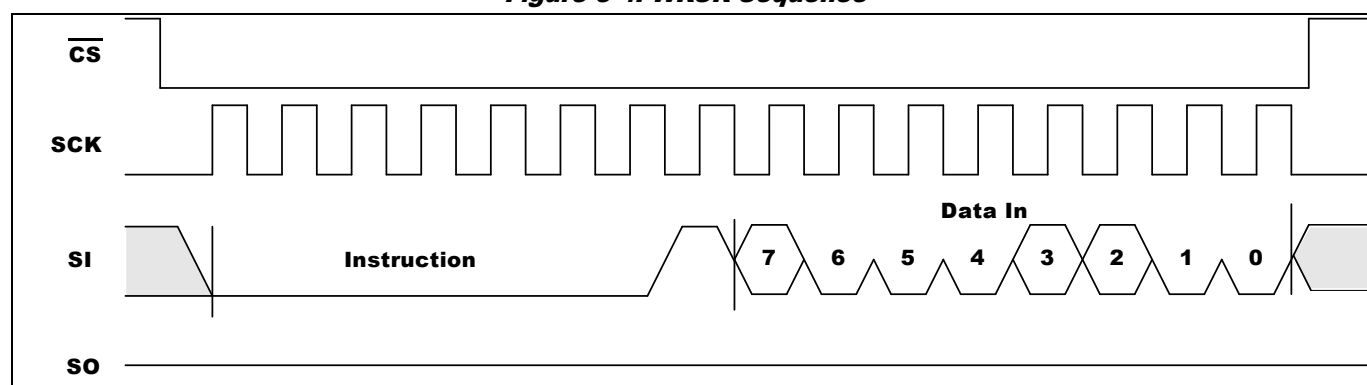

5.7 Read Data

This instruction includes an Op-Code and 16-bit address, then results the selected data to be shifted out from SO. Following the first data byte, additional sequential data can be output. If the data byte of the last address is initially output, then address will rollover to the first address in the array, and the output could loop indefinitely. At any time, a rising $\overline{\text{CS}}$ signal ceases the operation (Figure. 5-5).

Figure 5-5. READ Sequence



GT25C08A

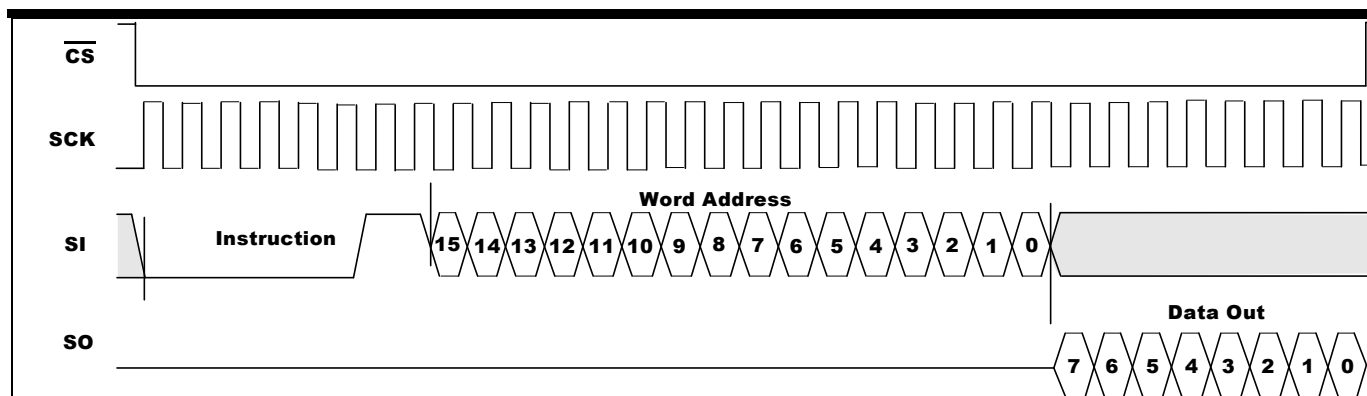

5.8 Write Data

The WRITE instruction contains an Op-Code, a 16-bit address and the first data byte. Additional data bytes may be supplied sequentially after the first byte. Each WRITE instruction can affect up to 32 bytes of data in a page. Each page has a starting address XXXXXXXX XXX00000 and an ending address XXXXXXXX XXX11111. After the last byte of data in a page is input, the address rolls over to the beginning of the same page. If more than 32 bytes of data is input during a single instruction, then only the last 32 bytes will be retained, but the initial data will be overwritten.

The contents of the array defined by Block Protection cannot be modified as long as that block configuration is selected. The contents of the array outside the Block Protection can only be modified if Write Enable (WEN) is set to 1. Therefore, it may be necessary that a WREN instruction is initiated prior to WRITE. Once Write operation is completed, WEN is reset for complete chip write protection (Figure. 5-6). Besides, Hardware Write Protection has no effect on the memory array.

Figure 5-6. WRITE Sequence

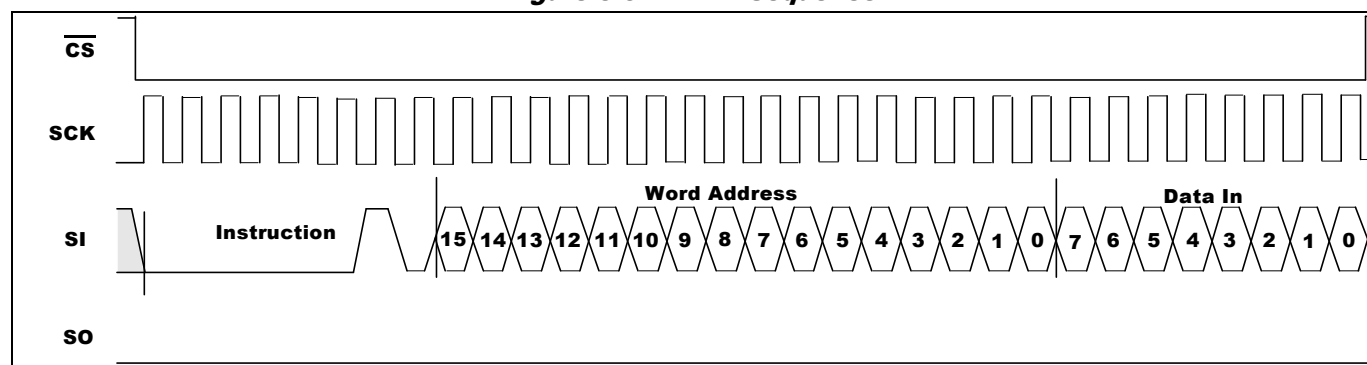

5.9 Identification Page

The GT25C08A optionally offers an additional Identification Page (32 bytes) in addition to the 8 Kbit memory, The Identification page contains two fields:

- Device identification: the three first byte are programmed by Giantec with the Device identification code, as shown in below Table.
- Application parameters: the bytes after the Device identification code are available for application specific data.

If the end application does not need to read the Device identification code, this field can be overwritten and used to store application-specific data. Once the application-specific data are written in the Identification page, the whole Identification page



GT25C08A

should be permanently locked in Read-only mode.

Address in Identification Page	Content	Value
00h	Giantec Manufacturer coder	C3h
01h	SPI Family code	00h
02h	Memory Density code	0Ch

5.9.1 Write Identification Page

The Identification Page (32 bytes) is an additional page which can be written and (later) permanently locked in Read-only mode. Writing this page is achieved with the Write Identification Page instruction (see Table 5.4), the Chip Select signal (\overline{CS}) is first driven low. The bits of the instruction byte, address byte, and at least one data byte are then shifted in on Serial Data input (SI). Address bit A10 must be 0, address bits [A15:A11] and [A9:A5] are Don't Care, the [A4:A0] address bits define the byte address inside the identification page. The instruction sequence is shown in Figure 5-7.

Figure 5-7. Write Identification Page Sequence

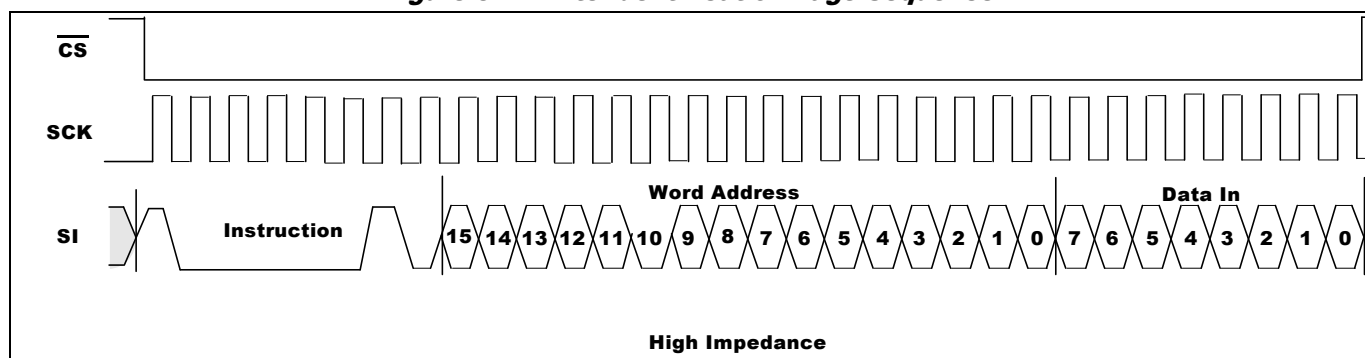

5.9.2 Lock Identification Page

The Lock ID instruction permanently locks the Identification Page in read-only mode. Before this instruction can be accepted, a Write Enable (WREN) instruction must have been executed. The Lock ID instruction is issued by driving Chip Select (\overline{CS}) low, sending the instruction code, the address and a data byte on Serial Data input (SI), and driving Chip Select (\overline{CS}) high. In the address sent, A10 must be equal to 1, all other address bits are Don't Care. The data byte sent must be equal to the binary value xxxx xx1x, where x = Don't Care.

Chip Select (\overline{CS}) must be driven high after the rising edge of Serial Clock (SCK) that latches in the eighth bit of the data byte, and before the next rising edge of Serial Clock (SCK). Otherwise, the Lock ID instruction is not executed. Driving Chip Select (\overline{CS}) high at a byte boundary of the input data triggers the self-timed write cycle whose duration is T_{WR} . The instruction sequence is shown in Figure 5-8.

The instruction is not accepted, and so not executed, under the following conditions:

- If the Write Enable Latch (WEL) bit has not been set to 1 (by previously executing a Write Enable instruction).
- If Status register bits (BP1, BP0) = (1,1).
- If a write cycle is already in progress.
- If the device has not been deselected, by Chip Select (\overline{CS}) being driven high, at a byte boundary (after the eighth bit, b0, of the last data byte that was latched in).

If the Identification page is locked by the Lock Status bit



The Lock Identification Page instruction (Lock ID) permanently locks the Identification page in Read-only mode. The Lock ID instruction is similar to Byte Write (into memory array) with the following specific conditions:

- Address bit A10 must be '1'; all other address bits are don't care.
- The data byte must be equal to the binary value xxxx xx1x, where x is don't care.

Figure 5-8. Lock ID Sequence

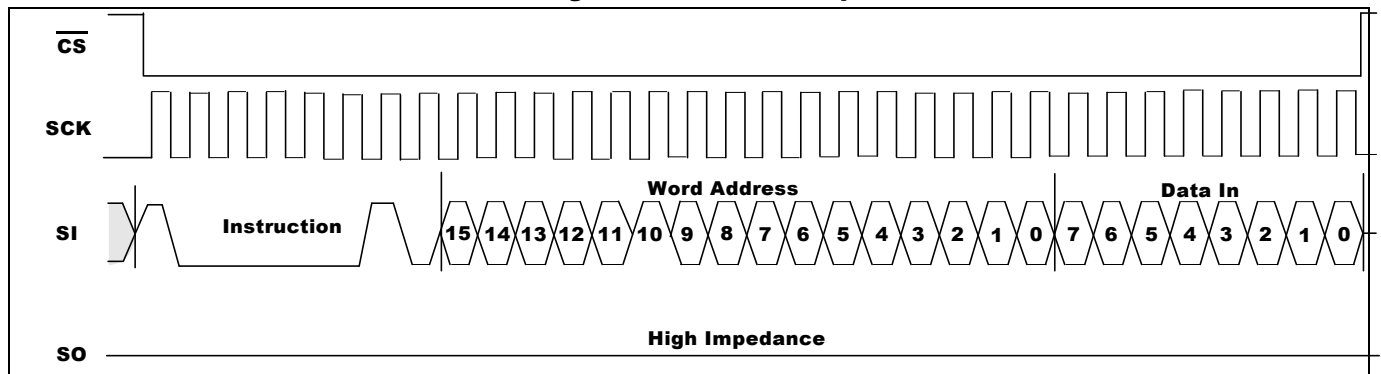

5.9.3 Read Identification Page

The Identification Page (32 bytes) is an additional page which can be written and (later) permanently locked in Read-only mode. Reading this page is achieved with the Read Identification Page instruction (see Table 5.4).

The Chip Select signal (\overline{CS}) is first driven low, the bits of the instruction byte and address bytes are then shifted in, on Serial Data input (SI). Address bit A10 must be 0, address bits [A15:A11] and [A9:A5] are Don't Care, and the data byte pointed to by [A4:A0] is shifted out on Serial Data output (SO). If Chip Select (\overline{CS}) continues to be driven low, the internal address register is automatically incremented, and the byte of data at the new address is shifted out.

The number of bytes to read in the ID page must not exceed the page boundary (32 bytes). There is no roll over feature in ID page. The read cycle is terminated by driving Chip Select (\overline{CS}) high. The rising edge of the Chip Select (\overline{CS}) signal can occur at any time during the cycle. The first byte addressed can be any byte within any page (Figure. 5-9).

The instruction is not accepted, and is not executed, if a write cycle is currently in progress.

Figure 5-9. Read Identification Page Sequence

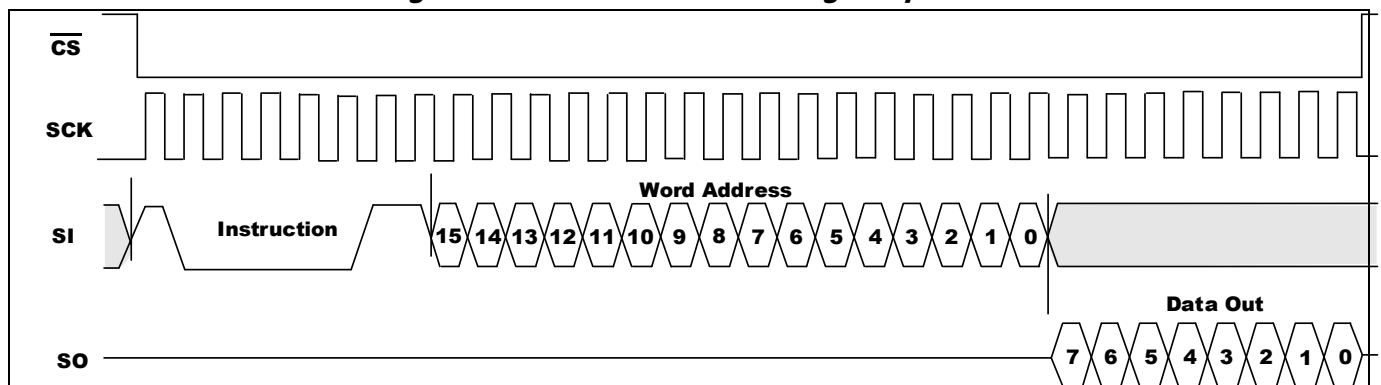



GT25C08A

5.9.4 Read the lock status

The Read Lock Status instruction is used to read the lock status.

To send this instruction to the device, Chip Select (\overline{CS}) first has to be driven low. The bits of the instruction byte and address bytes are then shifted in (MSB first) on Serial Data input (SI). Address bit A10 must be 1; all other address bits are Don't Care (it might be easier to define these bits as 0, as shown in Table 5.5). The Lock bit is the LSB (Least Significant Bit) of the byte read on Serial Data output (SO). It is at '1' when the lock is active and at '0' when the lock is not active. If Chip Select (\overline{CS}) continues to be driven low, the same data byte is shifted out.

The read cycle is terminated by driving Chip Select (\overline{CS}) high. The instruction sequence is shown in Figure 14.

The Read Lock Status instruction is not accepted and not executed if a Write cycle is currently in progress.

Figure 5-10. Read Lock Status Sequence

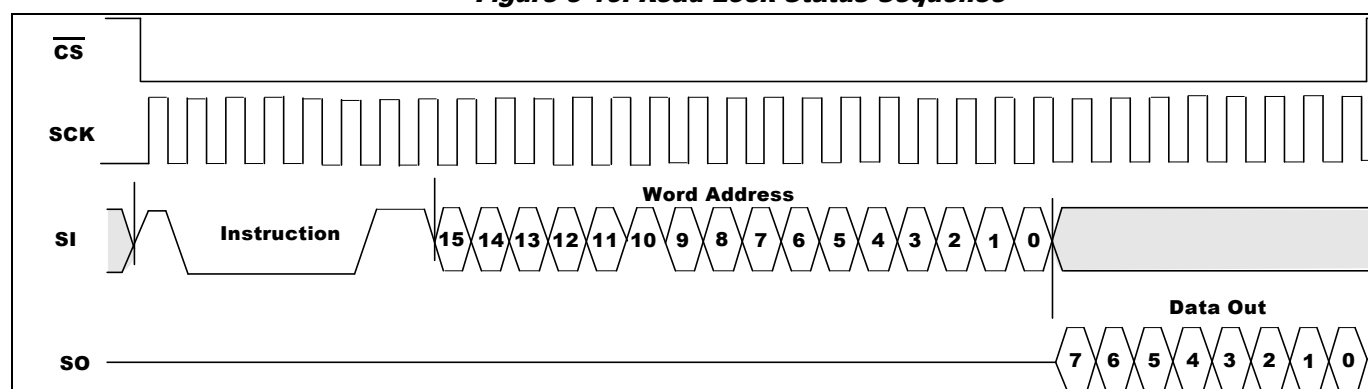

5.10 Delivery State

GT25C08A is shipped erased status with all bytes value as FFh.



GT25C08A

6. Application Recommendation

6.1 Operating Supply Voltage

Prior to selecting the memory and issuing instructions to it, a valid and stable VCC voltage within the specified [VCC(min), VCC(max)] range must be applied. This voltage must remain stable and valid until the end of the transmission of the instruction and, for a Write instruction, until the completion of the internal Write cycle (tW).

In order to filter out small ripples on VCC, it is recommended to connect a decoupling capacitor (typically 0.1 μ f) between VCC and GND.

6.2 Power-up conditions

During power ramp up, once VCC level reaches the power on reset threshold, the EEPROM internal logic is reset to a known state. While VCC reaches the stable level above the minimum operation voltage, the EEPROM can be operated properly.

Therefore, in a good power on reset, VCC should always begin at 0V and rise straight to its normal operating level, instead of being at an uncertain level. Only after a good power on reset, can EEPROM work normally.

At power-up, the device does not respond to any instruction until VCC reaches the internal threshold voltage (this threshold is defined in the DC characteristic Table as V_{RES}).

When VCC passes over the POR threshold, the device is reset and in the following state:

- in the Standby power mode
- deselected

As soon as the VCC voltage has reached a stable value within the [VCC(min), VCC(max)] range, the device is ready for operation.

6.3 Power-down

During power-down (continuous decrease in the VCC supply voltage below the minimum VCC operating voltage), the device must be in Standby power mode (that is after a STOP condition or after the completion of the Write cycle tW if an internal Write cycle is in progress).

6.4 ECC (Error Correction Code) and Write cycling

The Error Correction Code (ECC) is an internal logic function which is transparent for the SPI communication protocol.

The ECC logic is implemented on each group of four EEPROM bytes ^[1]. Inside a group, if a single bit out of the four bytes happens to be erroneous during a Read operation, the ECC detects this bit and replaces it with the correct value. The read reliability is therefore much improved.

Even if the ECC function is performed on groups of four bytes, a single byte can be written independently. In this case, the ECC function also writes the three other bytes located in the same group ^[1]. As a consequence, the maximum cycling budget is defined at group level and the cycling can be distributed over the 4 bytes of the group: the sum of the cycles seen by byte0, byte1, byte2 and byte3 of the same group must remain below the maximum value defined in 7.4 Reliability.

Note: 1. A group of four bytes is located at addresses [4*N, 4*N+1, 4*N+2, 4*N+3], where N is an integer.



GT25C08A

7. Electrical Characteristics

7.1 Absolute Maximum Ratings

Symbol	Parameter	Value	Unit
V _S	Supply Voltage	-0.5 to V _{CC} + 1	V
V _P	Voltage on Any Pin	-0.5 to V _{CC} + 1	V
T _{STG}	Storage Temperature	-65 to +150	°C
I _{OUT}	Output Current	5	mA
V _{ESD}	Electrostatic pulse (Human Body model)	±8000	V

Note: Stress greater than those listed under Absolute Maximum Ratings may cause permanent damage to the device. This is a stress rating only and functional operation of the device at these or any other condition outside those indicated in the operational sections of this specification is not implied. Exposure to absolute maximum rating conditions for extended periods may affect reliability.

7.2 Operating Range

Range	Ambient Temperature (T _A)	V _{CC}
Automotive Grade 1	-40°C to +125°C	1.7V to 5.5V

7.3 Capacitance

Symbol	Parameter ^[1, 2]	Conditions	Max.	Unit
C _{IN}	Input Capacitance	V _{IN} = 0V	6	pF
C _{I/O}	Input / Output Capacitance	V _{I/O} = 0V	8	pF

Notes: ^[1] Tested initially and after any design or process changes that may affect these parameters and not 100% tested.

^[2] Test conditions: T_A = 25°C, f = 1 MHz, V_{CC} = 5.0V.

7.4 Reliability

Symbol	Parameter	Condition	Min.	Unit
End	Endurance	T _a =+25°C	4 million	Program / Erase Cycles
		T _a =+85°C	1.2 million	
		T _a =+125°C	600 k	
DR	Data Retention	T _a =+25°C	100	Years
		T _a =+125°C	50	



GT25C08A

7.5 Power Up/Down and Voltage Drop

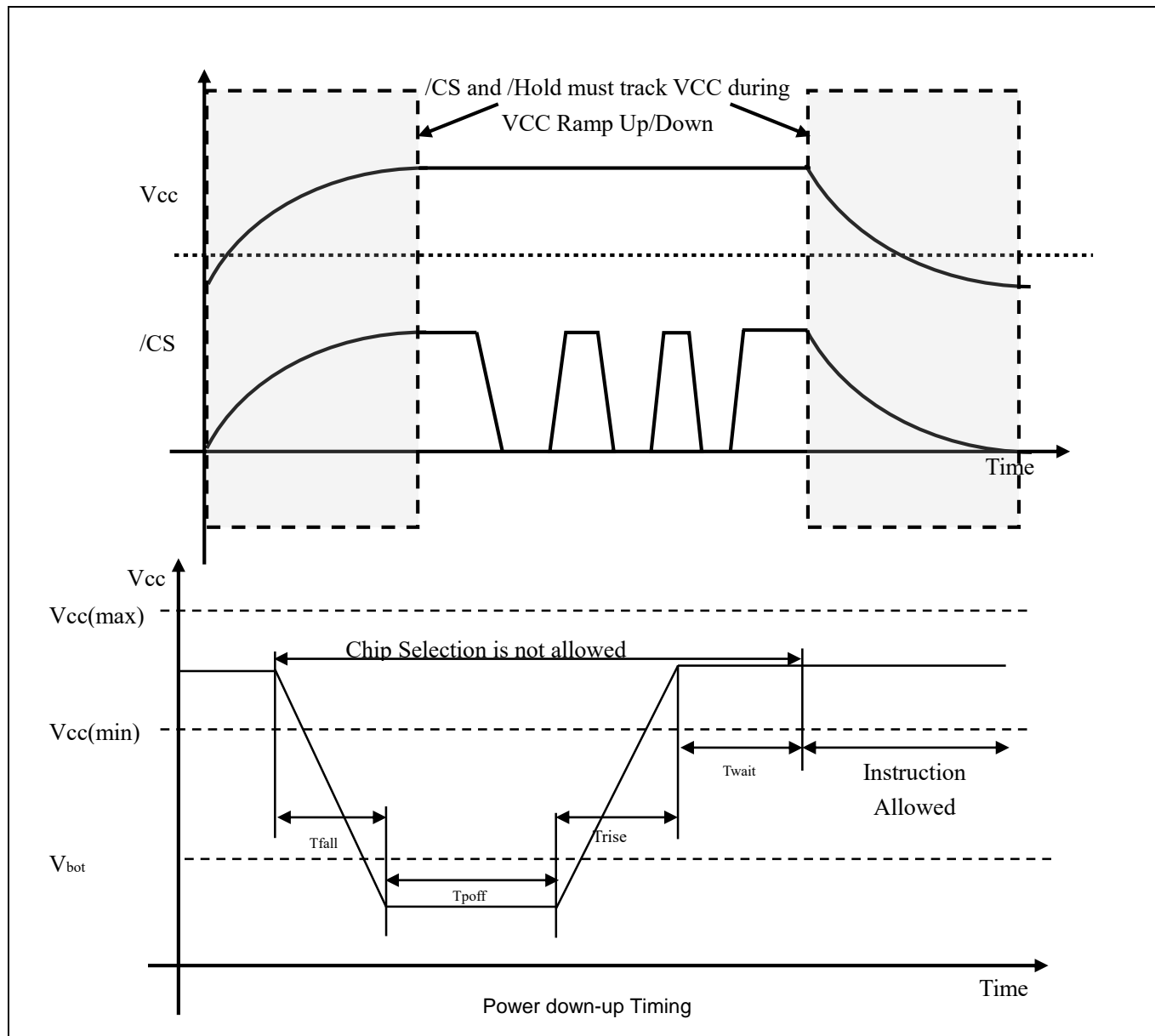

Symbol	Parameter	min	max	unit
V _{bot}	VCC at power off		0.2	V
T _{fall}	VCC min to V _{bot}	1		ms
T _{poFF}	VCC at power off time	20		ms
T _{rise}	V _{bot} to VCC min		3	ms
T _{wait}	VCC Min to Instruction	2		ms

* All parameters may be changed after the design or process change.



GT25C08A

7.6 DC Electrical Characteristic

Symbol	Parameter	Vcc	Test Conditions	Min.	Max.	Unit
V _{CC}	Supply Voltage			1.7	5.5	V
V _{IH}	Input High Voltage			0.7* VCC	V _{CC} +0.5	V
V _{IL}	Input Low Voltage			-0.3	0.3* VCC	V
I _{LI}	Input Leakage Current		V _{IN} = 0V To V _{CC}	-2	2	μA
I _{LO}	Output Leakage Current		V _{OUT} = 0V To V _{CC} , \overline{CS} = V _{CC}	-2	2	μA
V _{OH}	Output High Voltage	1.7	I _{OH} = -0.1mA	0.8*VCC	—	V
		2.5	I _{OH} = -0.4mA	0.8*V _{CC}	—	V
		5	I _{OH} = -2 mA	0.8*V _{CC}	—	V
V _{OL}	Output Low Voltage	1.7	I _{OL} = 0.15 mA	—	0.2	V
		2.5	I _{OL} = 1.5 mA	—	0.4	V
		5	I _{OL} = 2 mA	—	0.4	V
I _{CC}	Operating Current	1.7	Read/Write at 5 MHz, SO=Open	—	3	mA
		2.5	Read/Write at 10 MHz, SO=Open	—	4	mA
		5	Read/Write at 20 MHz, SO=Open	—	6	mA
I _{SB}	Standby Current	1.7	V _{IN} = V _{CC} or GND, \overline{CS} = V _{CC}	—	5	μA
		2.5	V _{IN} = V _{CC} or GND, \overline{CS} = V _{CC}	—	8	μA
		5	V _{IN} = V _{CC} or GND, \overline{CS} = V _{CC}	—	12	μA



GT25C08A

7.7 AC Electrical Characteristic

Symbol	Parameter ^[1]	1.7V ≤ V _{CC} < 2.5V		2.5V ≤ V _{CC} < 4.5V		4.5V ≤ V _{CC} ≤ 5.5V		Unit
		Min.	Max.	Min.	Max.	Min.	Max.	
F _{SCK}	SCK Clock Frequency	0	5	0	10	0	20	MHz
T _{RI}	Input Rise Time	—	1	—	1	—	1	μs
T _{FI}	Input Fall Time	—	1	—	1	—	1	μs
T _{WH}	SCK High Time	80	—	40	—	20	—	ns
T _{WL}	SCK Low Time	80	—	40	—	20	—	ns
T _{CS}	$\overline{\text{CS}}$ High Time	100	—	50	—	25	—	ns
T _{CSS}	$\overline{\text{CS}}$ Setup Time	100	—	50	—	25	—	ns
T _{CSH}	$\overline{\text{CS}}$ Hold Time	100	—	50	—	25	—	ns
T _{SU}	Data In Setup Time	20	—	10	—	5	—	ns
T _H	Data In Hold Time	20	—	10	—	5	—	ns
T _{HD}	HOLD Setup Time	20	—	10	—	5	—	ns
T _{CD}	HOLD Hold Time	20	—	10	—	5	—	ns
T _V ^[2]	Output Valid	0	80	0	40	0	20	ns
T _{HO}	Output Hold Time	0	—	0	—	0	—	ns
T _{LZ}	HOLD to Output Low Z	0	80	0	40	0	25	ns
T _{HZ}	HOLD to Output High Z	—	80	—	40	—	40	ns
T _{DIS}	Output Disable Time	—	80	—	40	—	40	ns
T _{WC}	Write Cycle Time	—	4	—	4	—	4	ms

Notes: ^[1] The parameters are characterized but not 100% tested.

^[2]C_L = 30pF (typical)



GT25C08A

7.8 Timing Diagrams

Figure 7-1. Synchronous Data Timing

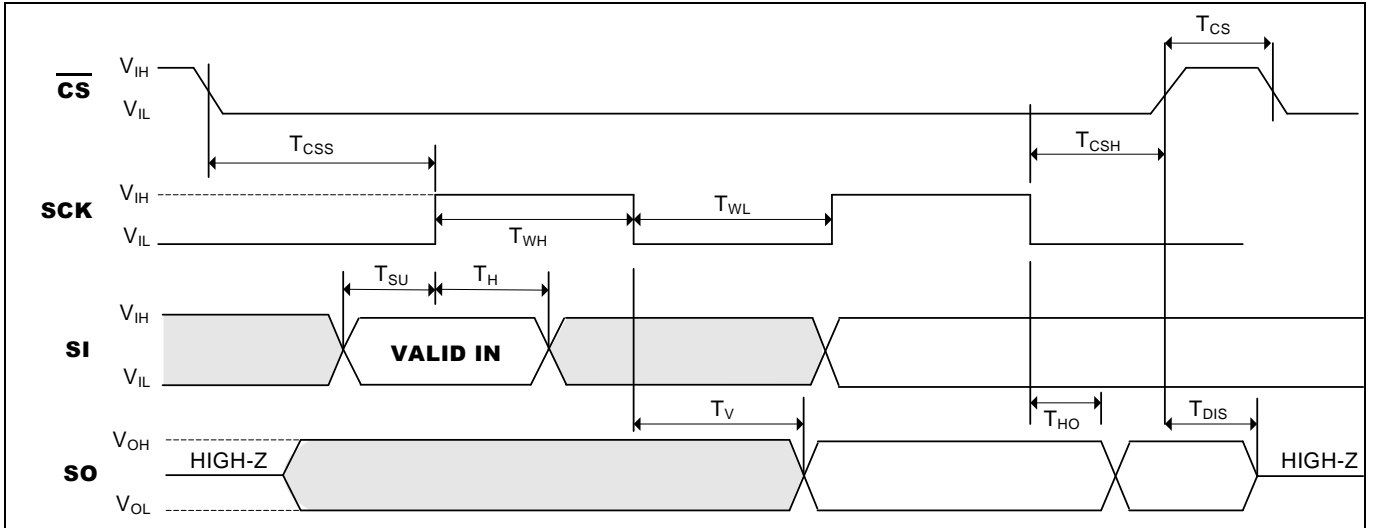
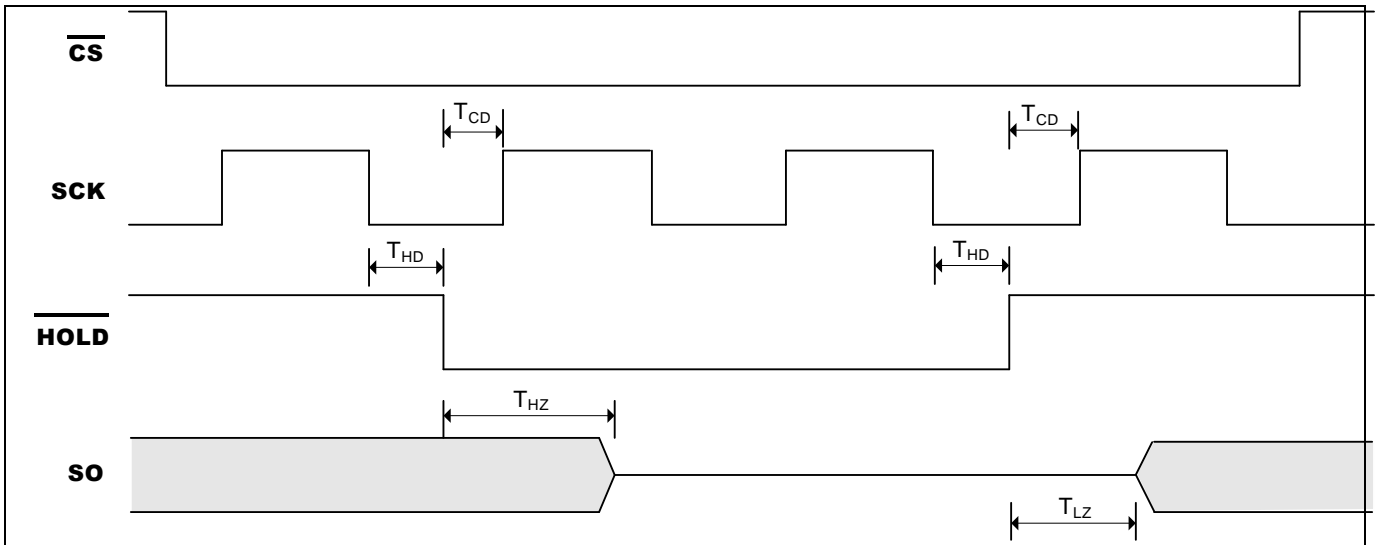

Figure 7-2. HOLD Timing





GT25C08A

8. Ordering Information

Voltage Range	Part Number*	Package (8-pin)*
1.7V to 5.5V	GT25C08A-2GLA1-TR	150-mil SOIC
	GT25C08A-2ZLA1-TR	3 x 4.4 mm TSSOP
	GT25C08A-2UDLA1-TR	2 x 3 x 0.55 mm UDFN

Rule:

Device Type GT25C = SPI EEPROM
Device Density 08A = 8K-bit Product version A
Operating Voltage 2 = 1.7/1.8-5.5V 3 = 2.3/2.5-5.5V
Package G = SOP8 150mil Z = TSSOP8 UD = UDFN8 2*3mm
Pb Status L = green status (HF, Meet reach, Rohs, etc.)
Temperature Range A1 = Automotive Grade1 (-40C ~ +125°C) A2 = Automotive Grade1 (-40C ~ +105°C)
Packing TR = Tape & Reel

Note:

1. Contact Giantec Sales Representatives for availability and other package information.
2. The product is packed in tape and reel "-TR" (4K per reel), except UDFN is 5K per reel.
3. Refer to Giantec website for related declaration document on lead free, RoHS, halogen free or Green, whichever is applicable.



GT25C08A

9. Top Markings

9.1 SOIC Package

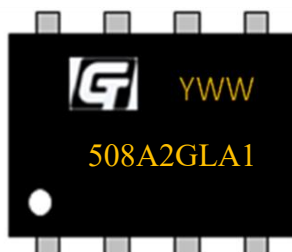

G: Giantec Logo
508A2GLA1: GT25C08A-2GLA1-TR
YWW: Date Code, Y=year, WW=week

9.2 TSSOP Package

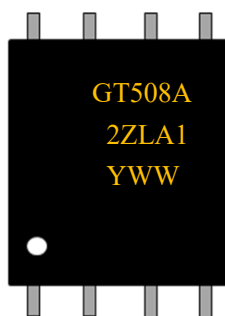

GT: Giantec Logo
508A2ZLA1: GT25C08A-2ZLA1-TR
YWW: Date Code, Y=year, WW=week

9.3 UDFN Package



GT: Giantec Logo
53A1: GT25C08A-2UDLA1-TR
YWW: Date Code, Y=year, WW=week



GT25C08A

10. Package Information

10.1 SOP

8L 150mil SOIC Package Outline

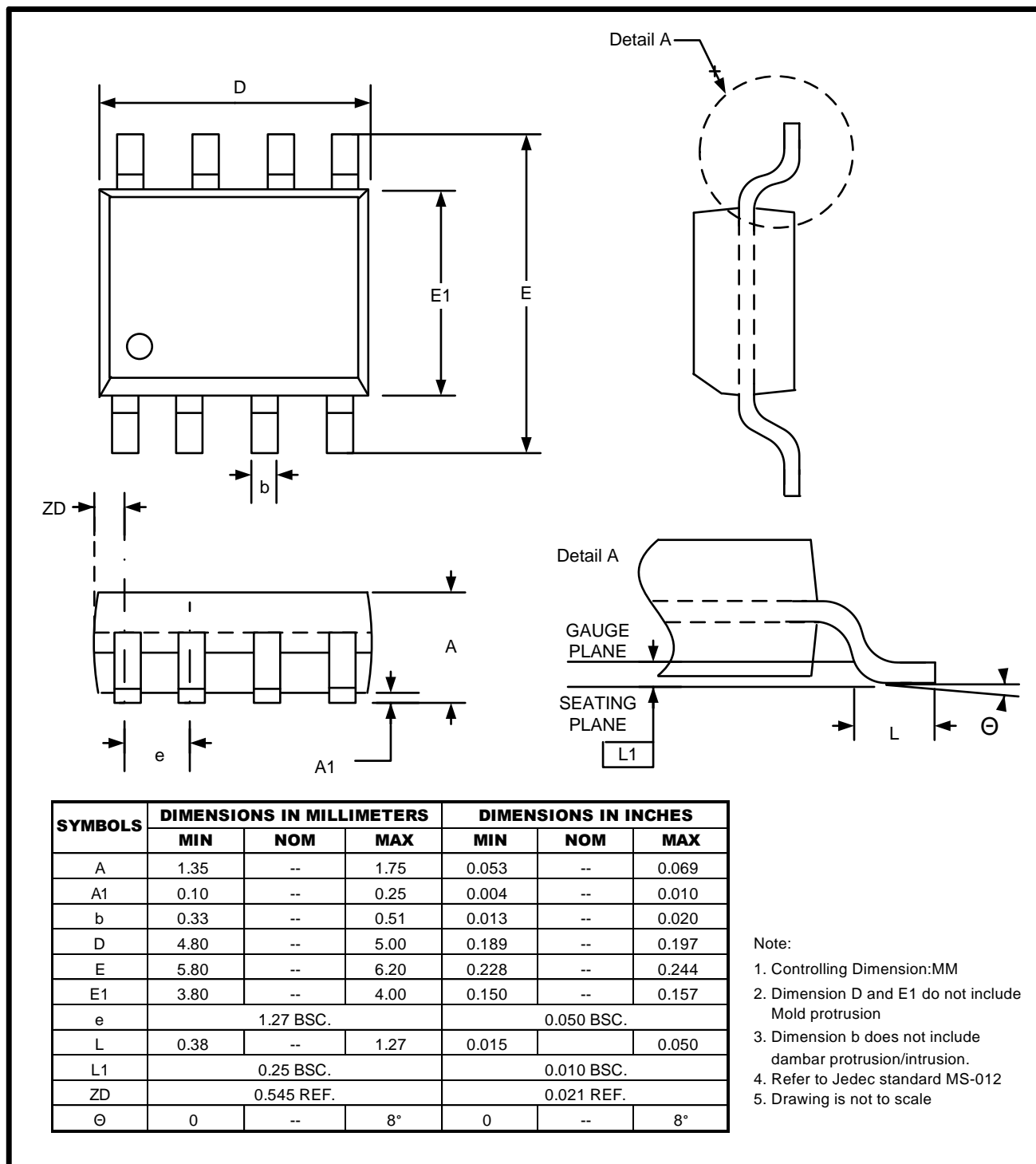



GT25C08A

10.2 TSSOP

8L 3x4.4mm TSSOP Package Outline

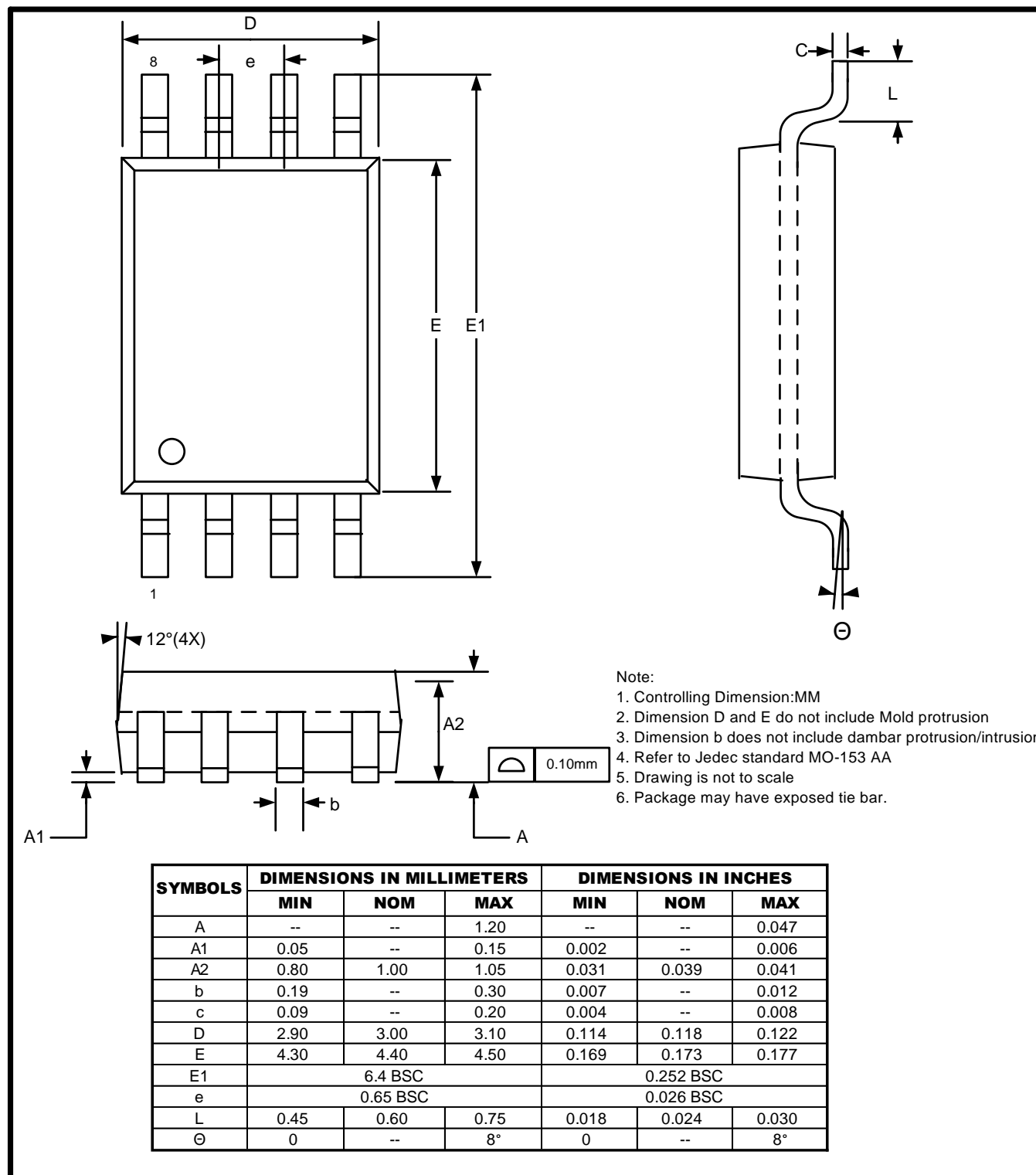



GT25C08A

10.3 UDFN

8L 2x3mm UDFN Package Outline

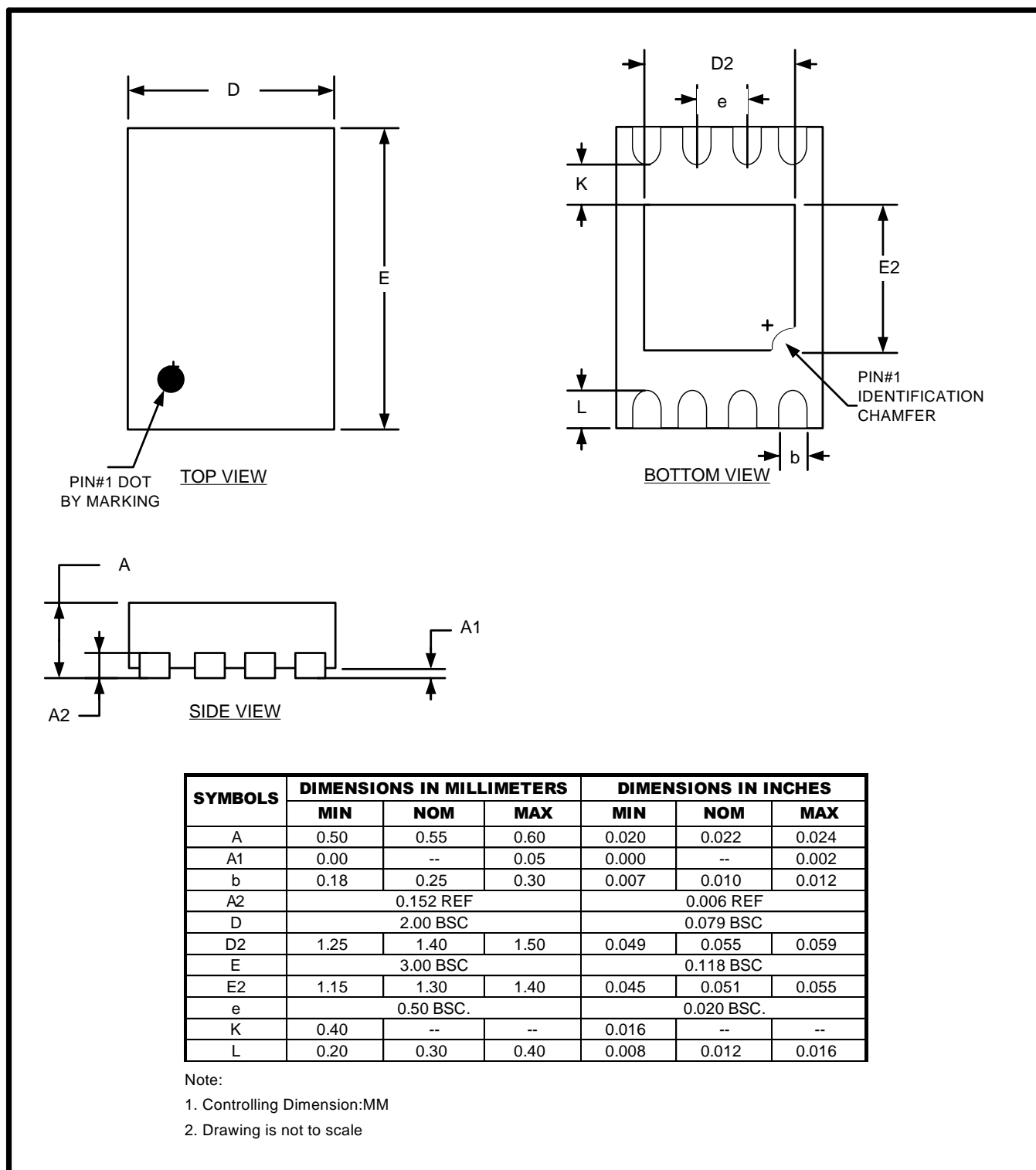



GT25C08A

11. Revision History

Revision	Date	Descriptions
A0	Apr. 2021	Initial version
A1	May. 2022	Update Logo and other

单击下面可查看定价，库存，交付和生命周期等信息

[>>Giantec\(聚辰半导体\)](#)