

Rockchip RK860 Datasheet

**Revision 1.3
Feb.2022**

Revision History

Date	Revision	Description
2022-02-23	1.3	1, Modify Package Thermal Characteristics description 2, Modify more description of the output current capability
2021-10-11	1.2	Update RK860-3 description
2021-06-23	1.1	Update Thermal Management information
2021-05-11	1.0	Initial release

Warranty Disclaimer

Rockchip Electronics Co.,Ltd makes no warranty, representation or guarantee (expressed, implied, statutory, or otherwise) by or with respect to anything in this document, and shall not be liable for any implied warranties of non-infringement, merchantability or fitness for a particular purpose or for any indirect, special or consequential damages.

Information furnished is believed to be accurate and reliable. However, Rockchip Electronics Co., Ltd assumes no responsibility for the consequences of use of such information or for any infringement of patents or other rights of third parties that may result from its use.

Rockchip Electronics Co.,Ltd's products are not designed, intended, or authorized for using as components in systems intended for surgical implant into the body, or other applications intended to support or sustain life, or for any other application in which the failure of the Rockchip Electronics Co.,Ltd's product could create a situation where personal injury or death may occur, should buyer purchase or use Rockchip Electronics Co.,Ltd's products for any such unintended or unauthorized application, buyers shall indemnify and hold Rockchip Electronics Co.,Ltd and its officers, employees, subsidiaries, affiliates, and distributors harmless against all claims, costs, damages, expenses, and reasonable attorney fees arising out of, either directly or indirectly, any claim of personal injury or death that may be associated with such unintended or unauthorized use, even if such claim alleges that Rockchip Electronics Co.,Ltd was negligent regarding the design or manufacture of the part.

Copyright and Patent Right

Information in this document is provided solely to enable system and software implementers to use Rockchip Electronics Co., Ltd 's products. There are no expressed or implied copyright licenses granted hereunder to design or fabricate any integrated circuits or integrated circuits based on the information in this document.

Rockchip Electronics Co.,Ltd does not convey any license under its patent rights nor the rights of others.

All copyright and patent rights referenced in this document belong to their respective owners and shall be subject to corresponding copyright and patent licensing requirements.

Trademarks

Rockchip and Rockchip™ logo and the name of Rockchip Electronics Co.,Ltd's products are trademarks of Rockchip Electronics Co.,Ltd. and are exclusively owned by Rockchip Electronics Co.,Ltd. References to other companies and their products use trademarks owned by the respective companies and are for reference purpose only.

Confidentiality

The information contained herein (including any attachments) is confidential. The recipient hereby acknowledges the confidentiality of this document, and except for the specific purpose, this document shall not be disclosed to any third party.

Reverse engineering or disassembly is prohibited.

ROCKCHIP ELECTRONICS CO., LTD. RESERVES THE RIGHT TO MAKE CHANGES IN ITS PRODUCTS OR PRODUCT SPECIFICATIONS WITH THE INTENT TO IMPROVE FUNCTION OR DESIGN AT ANY TIME AND WITHOUT NOTICE AND IS NOT REQUIRED TO UNDATE THIS DOCUMENTATION TO REFLECT SUCH CHANGES.

Copyright © 2022 Rockchip Electronics Co.,Ltd.

All rights reserved. No part of this publication may be reproduced, stored in a retrieval system, or transmitted in any form or by any means, electric or mechanical, by photocopying, recording, or otherwise, without the prior written consent of Rockchip Electronics Co.,Ltd.

Chapter 1 Introduction

1.1 Overview

The RK860 is a high efficiency 2.4MHz synchronous step down DC/DC regulator IC capable of delivering up to 7A output current. It can operate over a wide input voltage range from 2.7V to 5.5V. And, it integrates a main switch and a synchronous switch with both very low $R_{DS(ON)}$ to minimize the conduction loss. The output voltage can be programmed from 0.7125V to 1.5V with 12.5mV/step or 0.5V to 1.5V with 6.25mV/step through I²C interface.

The RK860 is in a space saving, low profile WLCSP 1.65mm*2.05mm-20 package.

1.2 Feature

- Input voltage range: 2.7V-5.5V
- 2.4MHz switching frequency minimizes the external components
- Typical 70uA quiescent current when $V_{IN}=3.8V$ and $Temp=25^{\circ}C$
- Low $R_{DS(ON)}$ for internal switches(PFET/NFET):24mohm/16ohm @ $V_{IN}=3.8V$
- Programmable output voltage:0.7125V to 1.5V with 12.5mV/step or 0.5V to 1.5V with 6.25mV/step
- 7A continuous output current capability
- Capable for 0.24uH inductor and 22uF*2 ceramic capacitor
- Hic-cup mode protection for hard short condition
- Integrate inner protection: Cycle by cycle OCP and V_{IN} -OVP/UVLO/DIE-TSD
- RoHS compliant and Halogen free
- Compact package: WLCSP 1.65*2.05-20

1.3 Typical Application Diagrams

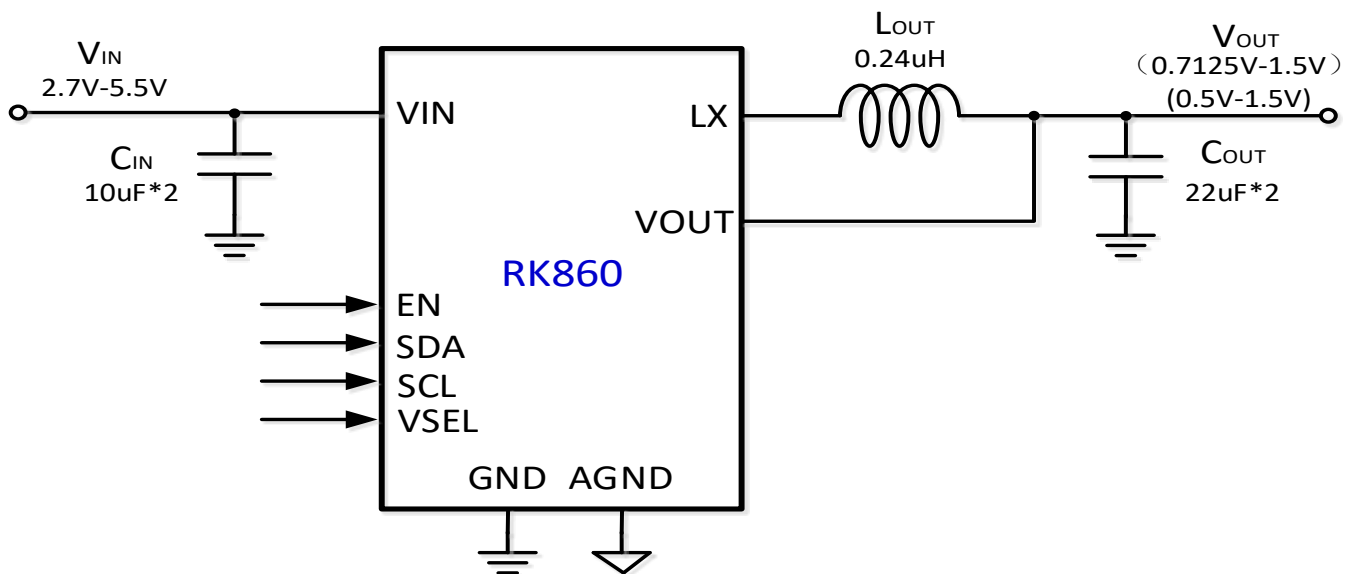

Fig. 1-1 RK860 Application

1.4 Pin Assignment

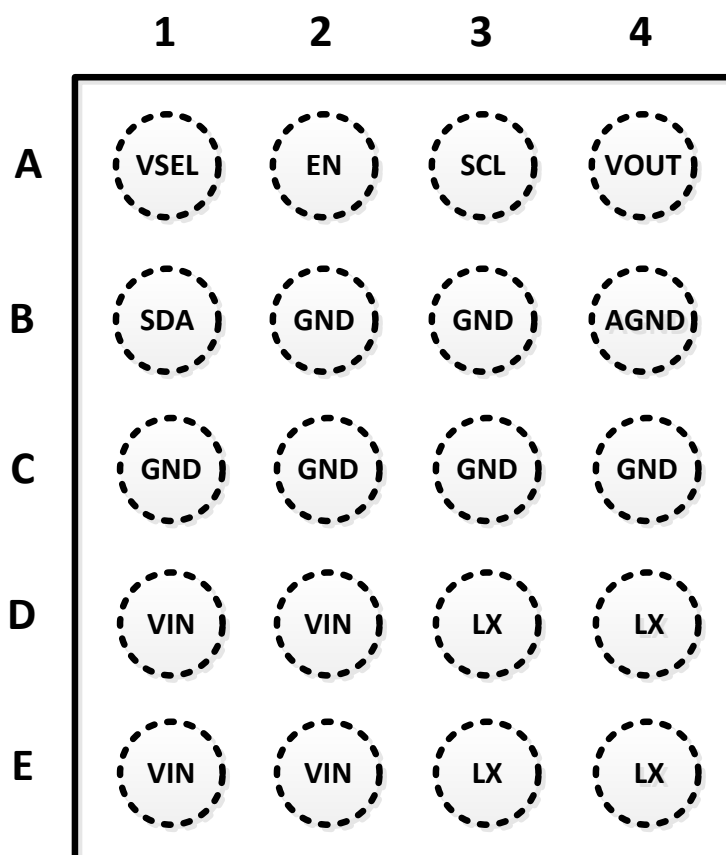

Fig. 1-2 Pin Assignment (Top view)

1.5 Pinout Number Order

Number	Name	Function	I/O
D1,D2,E1,E2	VIN	Power input pins. These pins must be decoupled to ground by 2 10uF ceramic capacitor as input filter at least.The input capacitor should be placed as close as possible between VIN and GND pins.	Power
D3,D4,E3,E4	LX	Switching node pin. Connect these pins to switching node of inductor.	Output
B2,B3,C1,C2,C3,C4	GND	Power ground pins.	Ground
B4	AGND	Analog ground pin.	
A1	VSEL	Voltage select pin. When this pin is low, V _{OUT} is set by the VSEL0 register. When this pin is high, V _{OUT} is set by the VSEL1 register.	Input
A2	EN	Enable control pin. Active high. Do not leave it floating.	Input
A3	SCL	I ² C interface clock line.	Input
B1	SDA	I ² C interface Bi-directional Data line. (Open darin)	I/O
A4	VOUT	Sense pin for output. Connect to the output capacitor side	Output

Chapter 2 Electrical Characteristics

Note 1. Stresses beyond the "Absolute Maximum Ratings" may cause permanent damage to the device. These are stress ratings only. Functional operation of the device at these or any other conditions beyond those indicated in the operational sections of the specification is not implied. Exposure to absolute maximum rating conditions for extended periods may affect device reliability.

Note 2: The device is not guaranteed to function outside its operating conditions.

2.1 Absolute Maximum Ratings(Note 1)

Parameter	Value	Units
Voltage range on pins VIN:	6.0	V
Voltage range on other pins	VIN+0.6	V
Continuous power dissipation, PD @ TA=25°C, WCSP4*5-20	0.5	W
Junction temperature range, T _j	-40~150	°C
Lead Temperature(soldering 10 sec), T _{SOLDER}	260	°C
Storage temperature range, T _s	-65~150	°C
ESD Susceptibility		
ESD HBM	2000	V
ESD CDM	1000	V

2.2 Recommended Operating Conditions(Note 2)

Parameter	Symbol	value	Units
Supply Input Voltage	V _{IN}	2.7~5.5	V
Output Voltage	V _{OUT}	0.5~1.5	V
Inductor	L	0.22~0.47	uH
Input Capacitor	C _{IN}	>10	uF
Output Capacitor	C _{OUT}	44~88	uF
Junction temperature range	T _j	-40~125	°C
Ambient temperature range	T _a	-40~85	°C

2.3 Electrical Characteristics

(With typical application circuit shown in below part, V_{IN}=3.8V, V_{OUT}=1.0V, L=0.24uH, C_{OUT}=22uF*2, T_A=25°C unless otherwise specified.)

PARAMETERS	SYMBOL	Note	MIN	TYP	MAX	UNIT
The UVLO threshold voltage of VIN	V _{IN_UVLO}	Vin rising		2.55	2.65	V
The UVLO Hysteresis voltage of VIN	V _{IN_UVLO_HYS}	Vin falling		150		mV
The OVP threshold voltage of VIN	V _{IN_OV}	Vin rising		6		V
The OVP Hysteresis voltage of VIN	V _{IN_OV_HYS}	Vin falling		200		mV
Quiescent Current	I _q	No switching, vfb=105%Vref.		70		uA
Shutdown current	I _{sd}	EN=L		0.1		uA
Software shutdown current	I _{sd_soft}	EN=H, BUCK_EN=L		25		uA

PARAMETERS	SYMBOL	Note	MIN	TYP	MAX	UNIT
Internal soft-start time	Tss	Vout=1.0V, from BUCK_EN rising edge to Vout>92%.		260		uS
Oscillator Frequency	Fclk	PWM mode or FPWM mode	2.2	2.4	2.6	MHz
Discharge resistance	Rdisc	EN=L/BUCK_EN=0		150		Ω
Input logic high threshold of signal (EN/VSEL)	VIH		1.1			V
	VIL				0.4	V
Input logic high threshold of signal (SDA/SCL)	VIH		1.26			V
	VIL				0.54	V
Vout Accuracy when FPWM	V _{REG1} (The output Voltage error)	Forced PWM, VOUT=1.0V	-0.6		+0.6	%
Vout Accuracy when PFM	V _{REG2} (The output Voltage error)	Auto PFM, VOUT=1.0V	-1.5		1.5	%
PMOS RDS(ON)	RDS(ON)P	VIN PIN to LX PIN, VIN=3.8V		24		m Ω
NMOS RDS(ON)	RDS(ON)N	LX PIN to GND PIN, VIN=3.8V		16		m Ω
Maximum current of PMOS	Ipeak		8.5			A
Maximum current of NMOS	Ivalley		7.0			A
Thermal shutdown temperature	TSD	Rising TSD threshold		150		$^{\circ}$ C
Thermal shutdown Hysteresis	TSD_HYS			25		$^{\circ}$ C

Chapter 3 Chip Version Description

DIE-ID	I2C-ADDR (7-bit)	Vout Range/V	Default Vout/V	STEP/ mV	DIE_ID
RK860-0	40H	0.7125-1.5	1.0	12.5	0X8
RK860-1	41H	0.7125-1.5	1.0	12.5	0X8
RK860-2	42H	0.5-1.5	0.8	6.25	0XA
RK860-3	43H	0.5-1.5	0.8	6.25	0XA

Chapter 4 Register Description

VSEL0_A

Address: (0x00)

Bit	Attr	Reset Value	Description
7	RW	0x1	BUCK_EN0: Software buck enable. 1:enable BUCK work; 0:shut off BUCK (When external EN pin is low. The regulator is off. When external EN pin is high, BUCK_EN bit takes precedent.)
6	RW	0x0	MODE0: 0=Allow auto-PFM mode during light load 1=Forced PWM mode
5:0	RW	0x17	NSEL0 : 12.5mV/step (just for DIE_ID=0X8) 000000=0.7125V; 000001=0.7250V; 000010=0.7375V; 010111=1.0000V; 111111=1.5V;

VSEL1_A

Address: (0x01)

Bit	Attr	Reset Value	Description
7	RW	0x1	BUCK_EN1: Software buck enable. 1:enable BUCK-LOOP work; 0:shut off BUCK-LOOP (When external EN pin is low. The regulator is off. When external EN pin is high, BUCK_EN bit takes precedent.)
6	RW	0x0	MODE1: 0=Allow auto-PFM mode during light load 1=Forced PWM mode
5:0	RW	0x17	NSEL1 : 12.5mV/step (just for DIE_ID=0X8) 000000=0.7125V; 000001=0.7250V; 000010=0.7375V; 010111=1.0000V; 111111=1.5V;

Control_Register

Address: (0x02)

Bit	Attr	Reset Value	Description
7	RW	0x1	Output Discharge: 0=discharge resistor is disabled. 1=discharge resistor is enabled.
6:4	RW	0x0	Slew Rate: Set the slew rate for positive voltage transitions. 000 = 10mV/0.15us 001 = 10mV/0.3us 010 = 10mV/0.6us 011 = 10mV/1.2us 100 = 10mV/2.4us 101 = 10mV/4.8us 110 = 10mV/9.6us 111 = 10mV/19.2us
3:0	RW	0x0	Always reads back 0. RESET: Setting to 1 resets all registers to default values.

ID1 Register

Address: (0x03)

Bit	Attr	Reset Value	Description
7:5	R	0x4	VENDOR: IC vendor Rockchip code.
4	R	0x0	Reserved: Always reads back 0.
3:0	R	0x8/0xA	DIE_ID: 0x8: Output Voltage from 0.7125V to 1.5V with 12.5mV/step 0xA: Output Voltage from 0.5V to 1.5V with 6.25mV/step

ID2 Register

Address: (0x04)

Bit	Attr	Reset Value	Description
7:4	R	0x0	Reserved: Always reads back 0.
3:0	R	NA	NA

PGOOD Register

Address: (0x05)

Bit	Attr	Reset Value	Description
7	R	0x0	PGOOD: 1:Buck is enabled and soft-start is completed. (Vout>92% normal set-value) 0: Vout is abnormal

Bit	Attr	Reset Value	Description
6	R	0x0	TSD: thermal shut down BUCK. 1: Tdie>150'C, 0: Tdie<125'C
5	R	0x0	IOVP: Over input voltage shut-off protection state. 1: VIN>6V, 0: VIN<5.8V
4	R	0x0	UVLO: Input voltage under-lock state. 1: VIN<2.4V, 0:VIN>2.55V
3:0	R	0x0	Reserved

VSEL0_B Register

Address: (0x06)

Bit	Attr	Reset Value	Description
7:0	R/W	0x30	NSEL0: when VSEL=L option just for DIE_ID=0XA 00,000,000 = 0.5V 00,000,001 = 0.50625V 00,000,010 = 0.51250V 00,110,000 = 0.8V 10,100,000 =1.5V >10,100,000=1.5V

VSEL1_B Register

Address: (0x07)

Bit	Attr	Reset Value	Description
7:0	R/W	0x30	NSEL1: when VSEL=H option just for DIE_ID=0XA 00,000,000 = 0.5V 00,000,001 = 0.50625V 00,000,010 = 0.51250V 00,110,000 = 0.8V 10,100,000 =1.5V >10,100,000=1.5V

Chapter 5 Typical Performance Characteristics

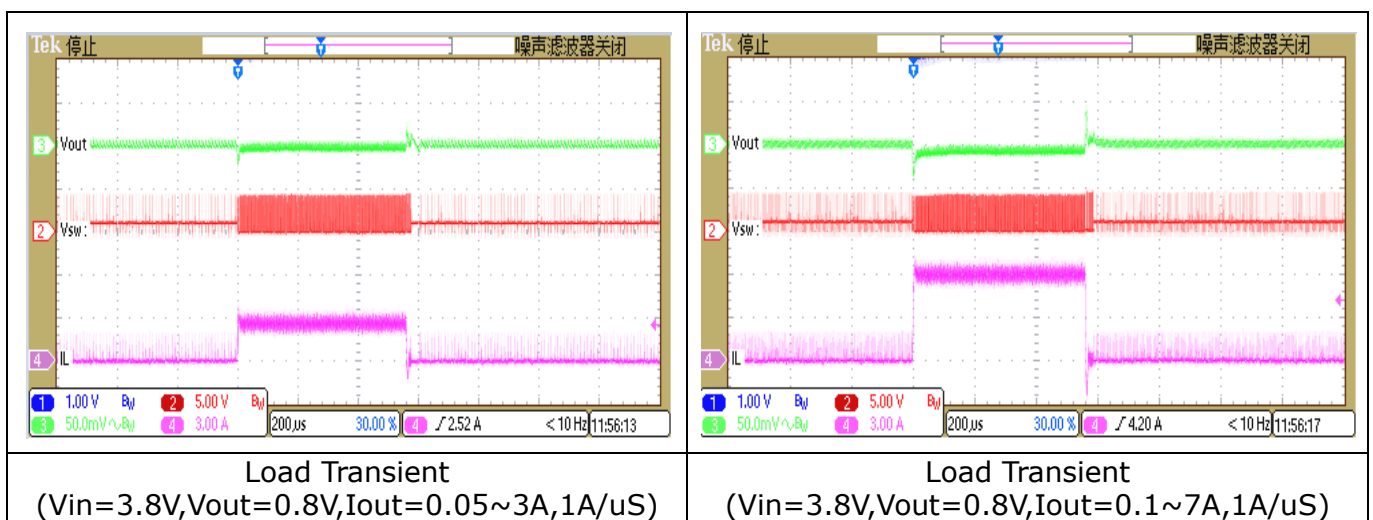
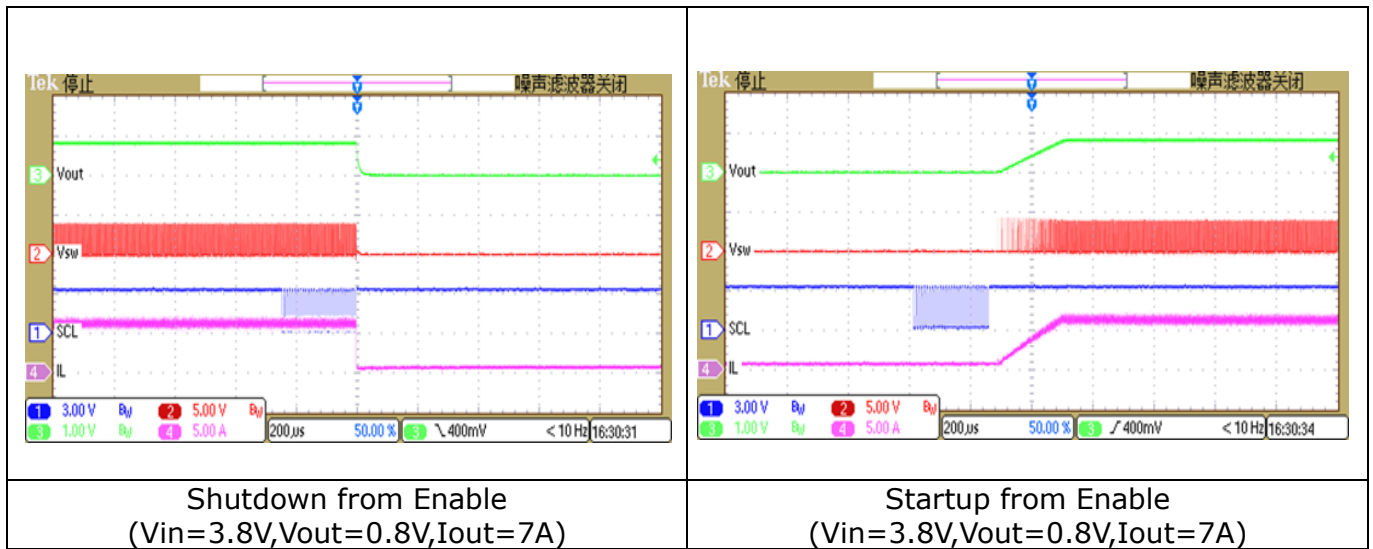
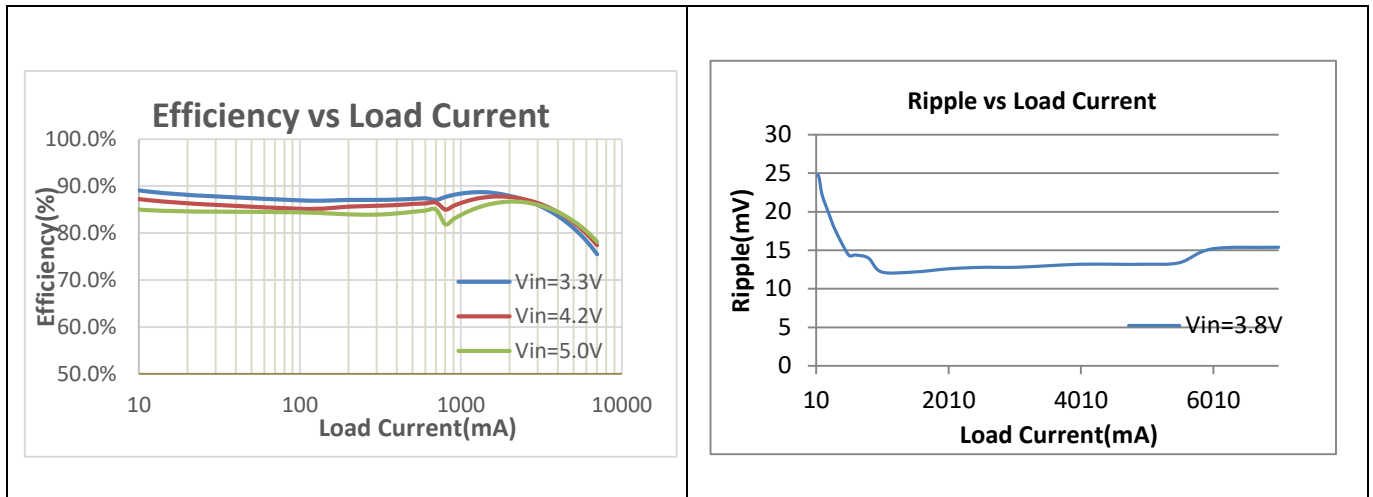

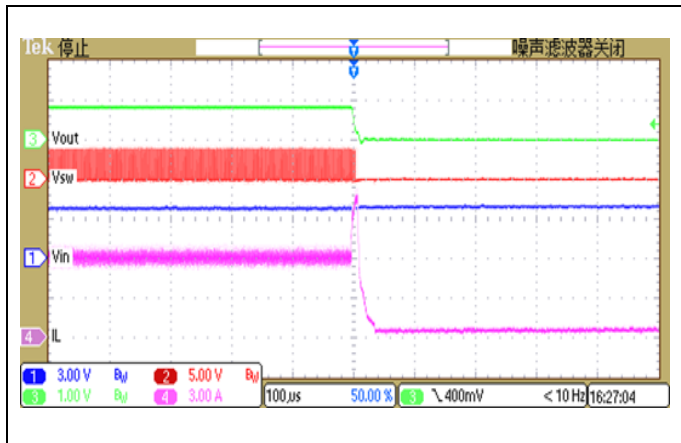

Short Circuit Protection
($V_{in}=3.8V, V_{out}=0.8V, I_{out}=7A \sim \text{short}$)

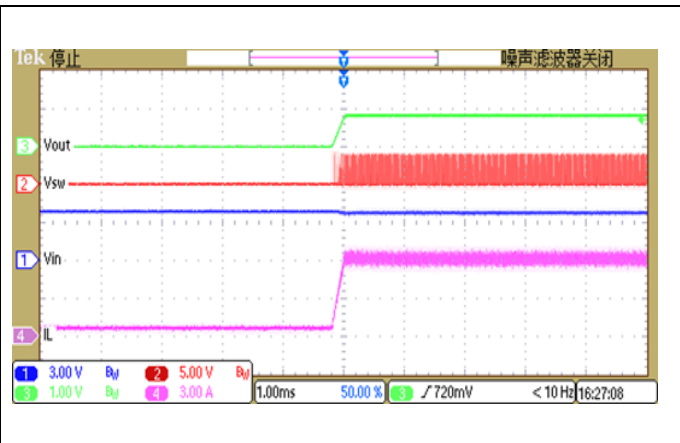

Short Circuit Protection
($V_{in}=3.8V, V_{out}=0.8V, I_{out}=\text{short} \sim 7A$)

Chapter 6 Package information

6.1 Ordering information

Orderable Device	RoHS status	Package	Package Qty
RK860-0	RoHS pass	WLCSP20(pitch 0.4mm)	5000 pcs/tape
RK860-1	RoHS pass	WLCSP20(pitch 0.4mm)	5000 pcs/tape
RK860-2	RoHS pass	WLCSP20(pitch 0.4mm)	5000 pcs/tape
RK860-3	RoHS pass	WLCSP20(pitch 0.4mm)	5000 pcs/tape

6.2 Top Marking

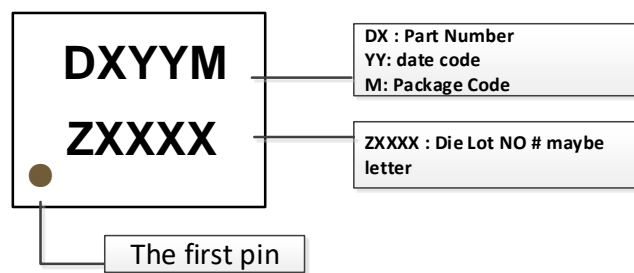

6.3 Dimension

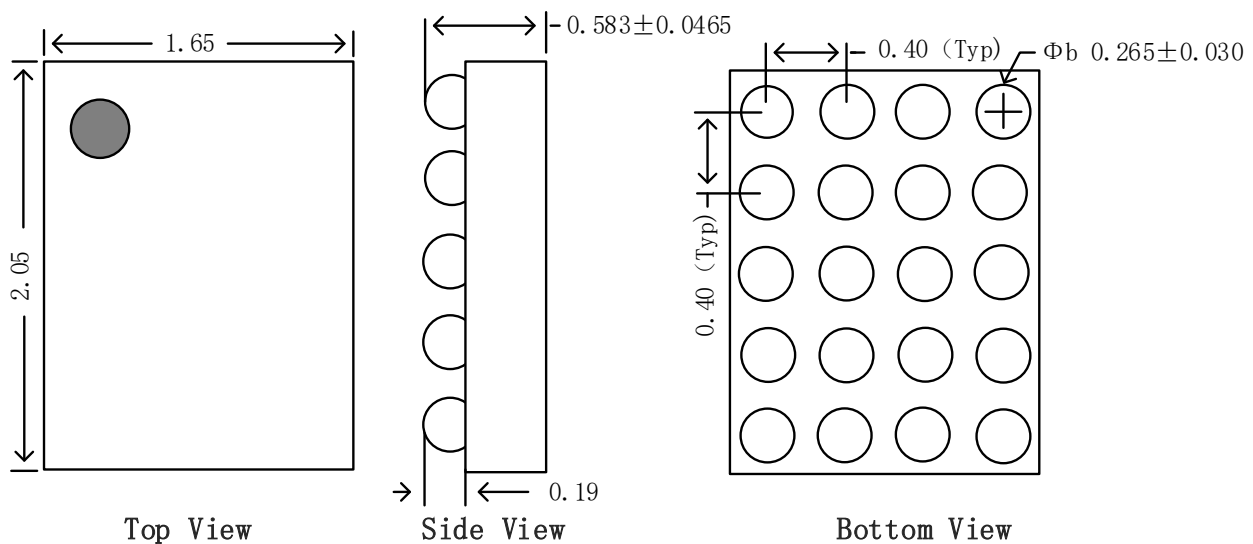

Notes: All dimension in MM

Fig. 6-1 WLCSP20 (Pitch is 0.4mm)

Note:

- Coplanarity applies to leads, corner leads and die attach pad.
- Dimension ϕb applies to metalized terminal and is measured between 0.15mm and 0.30mm from the terminal tip. If the terminal has the optional radius on the other end of the terminal, the dimension ϕb should not be measure in that radius area.
- 0.15mm of dimension ϕb is recommended in PCB layout.

Chapter 7 Thermal Management

7.1 Overview

For reliability and operability concerns, the absolute maximum junction temperature of RK860 has to be below 150°C.

Depending on the thermal mechanical design (Smartphone, Tablet, Personal Navigation Device, etc), the system thermal management software and worst case thermal applications, the junction temperature might be exposed to higher values than those specified above.

Therefore, it is recommended to perform thermal simulations at device level (Smartphone, Tablet, Personal Navigation Device, etc) with the measured power of the worst case UC of the device.

7.2 Package Thermal Characteristics

Table 1-1 provides the thermal resistance characteristics for the package used on this device.

Table 1-1 Thermal Resistance Characteristics

PACKAGE (WLCSP20)	Continuous power dissipation, PD @ TA=25°C,WCSF4*5- 20(W)	θ_{JA} , 2-layer PCB Thermal resistance from junction to ambient θ_{JA} (°C/ W)	θ_{JC} , 2-layer PCB Thermal resistance from junction to component θ_{JC} (°C/W)
RK860	0.5	64.44	17.76

Table 1-2 SnPb Eutectic Process-Classification Temperatures (TC)

Package Thickness	Volume mm³ <350	Volume mm³ ≥350
<2.5 mm	235 °C	220°C
≥2.5 mm	220 °C	220°C

Table 1-3 Pb-Free Process-Classification Temperatures (TC)

Package Thickness	Volume mm³ <350	Volume mm³ 350-2000	Volume mm³ >2000
<1.6 mm	260 °C	260 °C	260°C
1.6 mm-2.5 mm	260°C	250 °C	245°C
>2.5 mm	250 °C	245 °C	245°C

Note 1: At the discretion of the device manufacturer, but not the board assembler/user, the maximum peak package body temperature (TP) can exceed the values specified in Tables 1-2 or 1-3. The use of a higher Tp does not change the classification temperature (Tc).

Note 2: Package volume excludes external terminals (e.g., balls, bumps, lands, leads) and/or nonintegral heat sinks.

Note 3: The maximum component temperature reached during reflow depends on package thickness and volume. The use of convection reflow processes reduces the thermal gradients between packages. However, thermal gradients due to differences in thermal mass of SMD packages may still exist.

Note 4: Moisture sensitivity levels of components intended for use in a Pb-free assembly process shall be evaluated using the Pb-free classification temperatures and profiles defined in Tables 4.2 and 1-4, whether or not Pb-free.

Note 5: SMD packages classified to a give moisture sensitivity level by using Procedures or Criteria defined within any previous version of J-STD-020, JESD22-A112(rescinded),IPC-SM-786 (rescinded) do not need to be reclassified to the current revision unless a change in classification level or a higher peak classification temperature is desired.

Table 1-4 Classification Reflow Profiles

Profile Feature	Sn-Pb Eutectic Assembly	Pb-Free Assembly
Preheat & Soak		
Temperature min (T _{smin})	100°C	150°C
Temperature max(T _{smax})	150°C	200°C
Time (T _{smin} to T _{smax})(t _s)	60-120 seconds	60-120 seconds
Average ramp-up rate (T _{smax} to T _p)	3 °C /second max.	3 °C /second max.
Liquidous temperature (TL)	183 °C60-150 seconds	217 °C 60-150 seconds
Time at liquidous (tL)		
Peak package body temperature (T _p)*	See classification temp in Table 4.1	See classification temp in Table 4.2
Time(tp)* * within 5°C of the specified classification temperature (T _c)	20** seconds	30** seconds
Average ramp-down rate (T _p to T _{smax})	6°C /second max.	6 °C /second max.
Time 25 °C to peak temperature	6 minutes max.	8 minutes max.
*Tolerance for peak profile temperature (T _p) is defined as a supplier minimum and a user maximum.		
** Tolerance for time at peak profile temperature (T _p) is defined as a supplier minimum and a user maximum.		

Note 1: All temperatures refer to the center of the package, measured on the package body surface that is facing up during assembly reflow(e.g.,live-bug). If

parts are reflowed in other than the normal live-bug assembly reflow orientation (i.e.,dead-bug), T_p shall be within ±2 °C of the live-bug T_p and still meet the T_c requirements, otherwise, the profile shall be adjusted to achieve the latter. To accurately measure actual peak package body temperature refer to JEP140 for recommended thermocouple use.

Note 2: Reflow profiles in this document are for classification/preconditioning and are not meant to specify board assembly profiles. Actual board assembly

profiles should be developed based on specific process needs and board designs and should not exceed the parameters in Table 1-4.

For example, if T_c is 260 °C and time T_p is 30 seconds, this means the following for the supplier and the user.

For a supplier. The peak temperature must be at least 260 °C. The time above 255 C must be at least 30 seconds.

For a user: The peak temperature must not exceed 260 °C. The time above 255 °C must not exceed 30 seconds.

Note 3: All components in the test load shall meet the classification profile requirements.

Note 4: SMD packages classified to a given moisture sensitivity level by using Procedures or Criteria defined within any previous version of ,J-STD-020

JESD22-A112 (rescinded), IPC-SM-786(rescinded) do not need to be reclassified to the current revision unless a change in classification level or a higher peak classification temperature is desired.

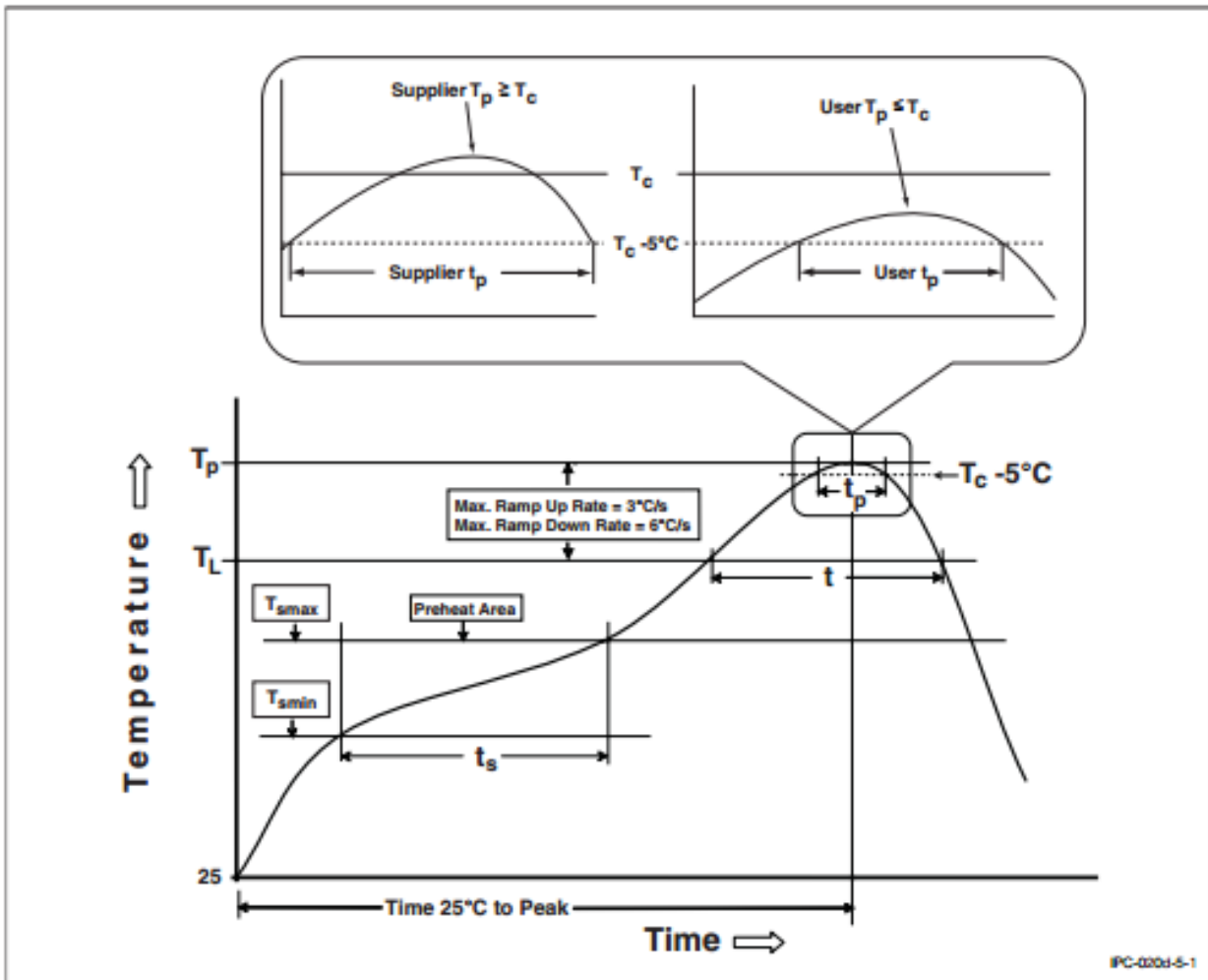

Figure 5-1 Classification Profile

单击下面可查看定价，库存，交付和生命周期等信息

[>>ROCKCHIP\(瑞芯微\)](#)