

Chip Bead ABNQ Series

**Automotive
AEC-Q200**

RoHS Compliant
Halogen Free
REACH Compliant



Noise
Suppression

Shield

Multilayer

Ferrite

High speed
Signal line

Part Numbering

A	BNQ	00	100505	121	Y	00
Grade	Series Name	Control Code	Dimensions Code (mm)	Impedance (Ω)	Tolerance	Internal Code
			100505 1.0x0.5x0.5	600 60	Y ±25%	
			160808 1.6x0.8x0.8	121 120		
				102 1000		

This specification applies to Multilayer Chip ferrite Bead for Automotive Electronics based on AEC-Q200 except for Power train and Safety.

ABNQ00100505 Type

■ Dimensions

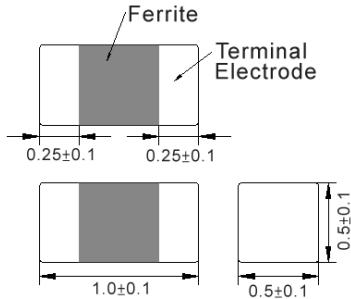

unit:mm

■ Recommended Land Pattern

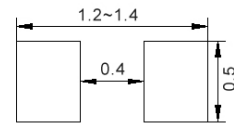

unit:mm

■ Electrical Characteristics

Part No.	Impedance (Ω)	Test Freq.	RDC (Ω)Max.	Rated Current (mA)Max.
ABNQ00100505100Y00	10	100 MHz,200 mV	0.10	500
ABNQ00100505470Y00	47	100 MHz,200 mV	0.30	400
ABNQ00100505750Y00	75	100 MHz,200 mV	0.30	400
ABNQ00100505121Y00	120	100 MHz,200 mV	0.40	350
ABNQ00100505221Y00	220	100 MHz,200 mV	0.60	200
ABNQ00100505601Y00	600	100 MHz,200 mV	1.20	200

Note: When ordering, please specify tolerance code. Tolerance: Y=±25%

1. Operating temperature range - 55°C ~ 125°C
2. Rate Current : Applied the current to coils, the temperature rise shall not be more than 30°C
3. Measure Equipment:
Z: HP4291A
RDC: HP4338B or CHEN HWA 502

ABNQ00100505 Type

Characteristics Graph

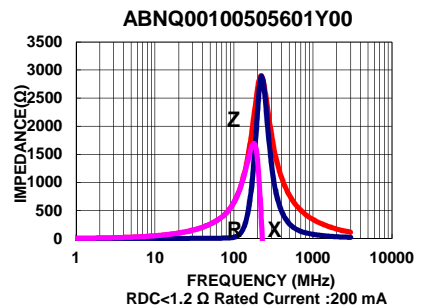
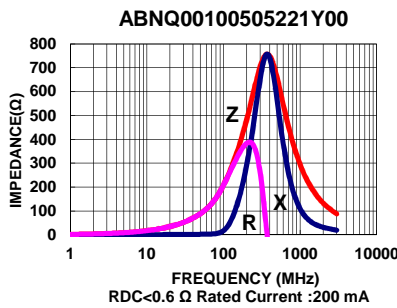
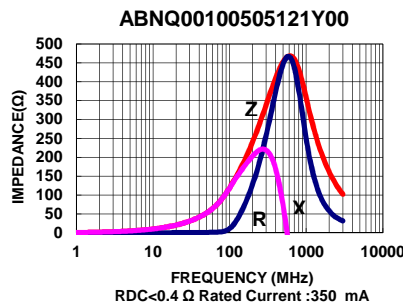
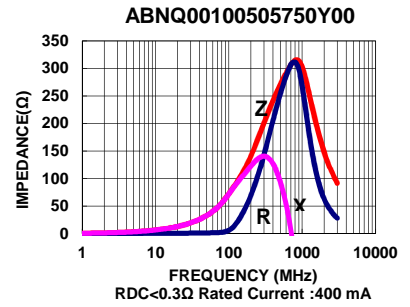
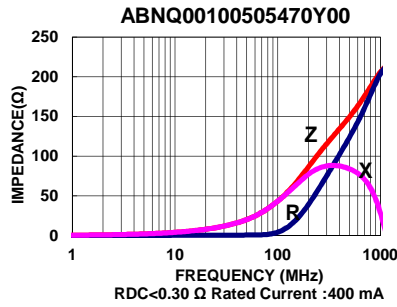
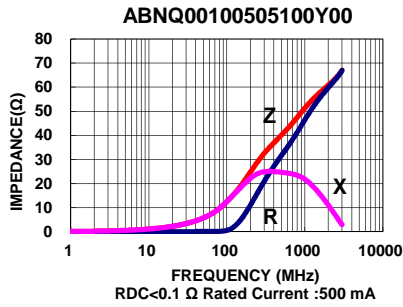

Please be sure to request approval specifications that provide further details of the products. Kindly note that the content of these specifications are subject to change or may be discontinued without prior notice. This product may not be designed/used in medical or high risk applications without Chilisin approval. Please contact our sales department before ordering.

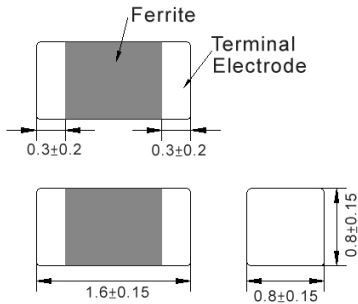
ABNQ00160808 Type
■ Dimensions

unit:mm

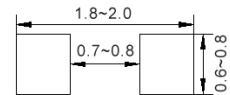
■ Recommended Land Pattern

unit:mm

■ Electrical Characteristics

Part No.	Impedance (Ω)	Test Freq.	RDC (Ω)Max.	Rated Current (mA)Max.
ABNQ00160808600Y00	60	100 MHz,200 mV	0.25	500
ABNQ00160808121Y00	120	100 MHz,200 mV	0.30	400
ABNQ00160808221Y00	220	100 MHz,200 mV	0.35	400
ABNQ00160808301Y00	300	100 MHz,200 mV	0.40	400
ABNQ00160808601Y00	600	100 MHz,200 mV	0.50	200
ABNQ00160808102Y00	1000	100 MHz,200 mV	0.60	200

Note: When ordering, please specify tolerance code. Tolerance: Y=±25%

1. Operating temperature range - 55°C ~ 125°C
2. Rate Current : Applied the current to coils, the temperature rise shall not be more than 30°C
3. Measure Equipment:
 Z: HP4291A
 RDC: HP4338B or CHEN HWA 502

ABNQ00160808 Type

Characteristics Graph

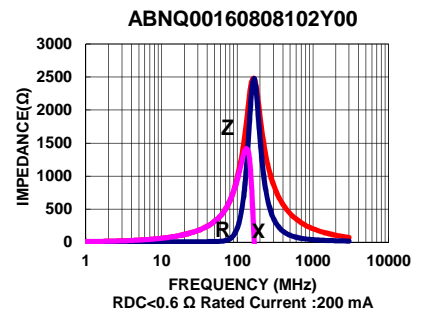
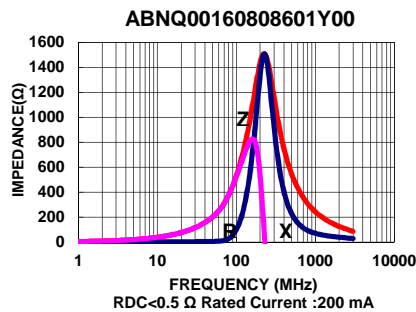
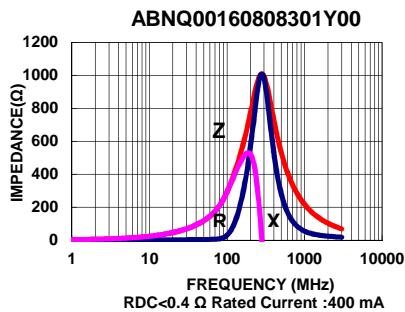
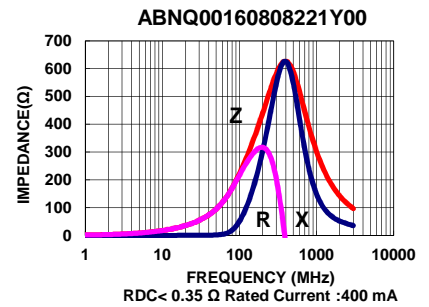
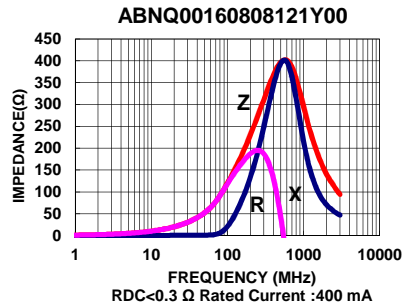
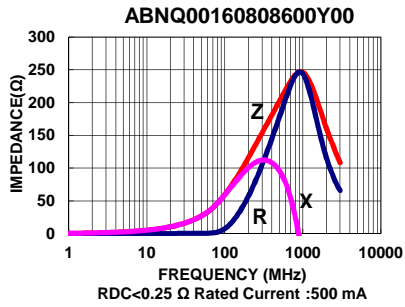

Please be sure to request approval specifications that provide further details of the products. Kindly note that the content of these specifications are subject to change or may be discontinued without prior notice. This product may not be designed/used in medical or high risk applications without Chilisin approval. Please contact our sales department before ordering.

■ Packaging

Tape Dimensions

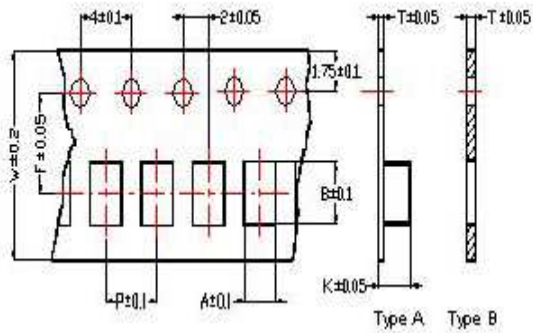

Tape Material

Carrier Tape: Polycarbonate (Tape A)
Carrier Tape: Paper (Tape B)
Cover Tape: Polystyrene

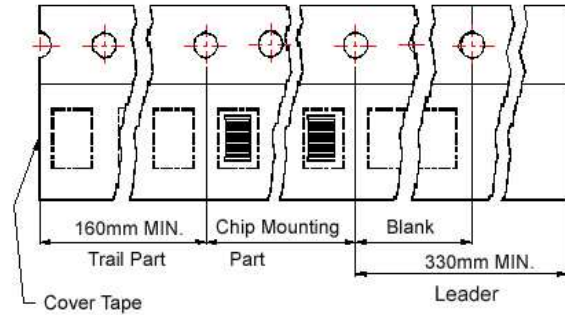

Reel Dimensions

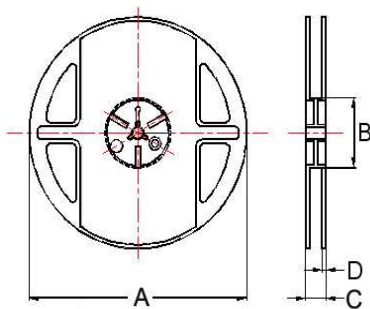

Dimensions in mm

TYPE	Tape Dimensions								Reel Dimensions				Quantity
	A	B	T	W	P	F	K	Tape	A	B	C	D	PCS / Reel
ABNQ00100505	0.62	1.12	0.60	8	2	3.5	-	B	178	60	12	2	10000
ABNQ00160808	1.05	1.85	0.95	8	4	3.5	-	B	178	60	12	2	4000

Please be sure to request approval specifications that provide further details of the products. Kindly note that the content of these specifications are subject to change or may be discontinued without prior notice. This product may not be designed/used in medical or high risk applications without Chilisin approval. Please contact our sales department before ordering.

单击下面可查看定价，库存，交付和生命周期等信息

[>>CHILISIN\(奇力新\)](#)