

**CoolSiC™ 2000 V SiC Trench MOSFET : Silicon Carbide MOSFET with .XT interconnection technology**

**Features**

- $V_{DS} = 2000\text{ V}$  at  $T_{vj} = 25^\circ\text{C}$
- $I_{DCC} = 89\text{ A}$  at  $T_c = 25^\circ\text{C}$
- $R_{DS(on)} = 24\text{ m}\Omega$  at  $V_{GS} = 18\text{ V}$ ,  $T_{vj} = 25^\circ\text{C}$
- Very low switching losses
- Benchmark gate threshold voltage,  $V_{GS(th)} = 4.5\text{ V}$
- Robust body diode for hard commutation
- .XT interconnection technology for best-in-class thermal performance

**Potential applications**

- String inverter
- Solar power optimizer
- EV-Charging

**Product validation**

- Qualified for industrial applications according to the relevant tests of JEDEC47/20/22
- Please also note the application note AN2019-05 for power and thermal cycling

**Description**

- 1 – drain
- 2 – source
- 3 – Kelvin sense contact
- 4 – gate

Note: the source and sense pins are not exchangeable, their exchange might lead to malfunction (only for 4pin, TO263-7L)

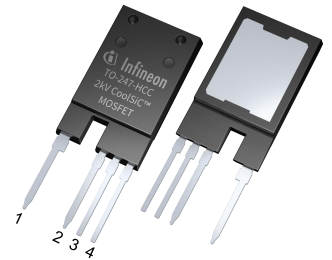

- Halogen-free
- Green
- Lead-free
- RoHS

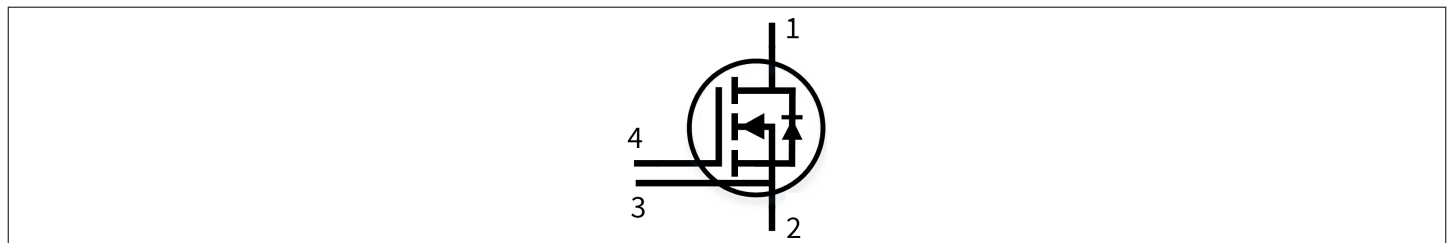

Type	Package	Marking
IMYH200R024M1H	PG-TO247-4-PLUS-NT14	20M1H024

## Table of contents

	<b>Description</b> .....	1
	<b>Features</b> .....	1
	<b>Potential applications</b> .....	1
	<b>Product validation</b> .....	1
	<b>Table of contents</b> .....	2
<b>1</b>	<b>Package</b> .....	3
<b>2</b>	<b>MOSFET</b> .....	3
<b>3</b>	<b>Body diode (MOSFET)</b> .....	6
<b>4</b>	<b>Characteristics diagrams</b> .....	7
<b>5</b>	<b>Package outlines</b> .....	13
<b>6</b>	<b>Testing conditions</b> .....	14
	<b>Revision history</b> .....	15
	<b>Disclaimer</b> .....	16

## 1 Package

**Table 1** Characteristic values

Parameter	Symbol	Note or test condition	Values			Unit
			Min.	Typ.	Max.	
Storage temperature	$T_{stg}$		-55		150	°C
Soldering temperature	$T_{sold}$	wave soldering 1.6 mm (0.063 in.) from case for 10 s			260	°C
Thermal resistance, junction-ambient	$R_{th(j-a)}$				62	K/W
MOSFET/body diode thermal resistance, junction-case	$R_{th(j-c)}$			0.20	0.26	K/W

## 2 MOSFET

**Table 2** Maximum rated values

Parameter	Symbol	Note or test condition	Values	Unit	
Drain-source voltage	$V_{DSS}$	$T_{vj} \geq 25\text{ °C}$	2000	V	
Continuous DC drain current for $R_{th(j-c,max)}$ , limited by $T_{vj(max)}$	$I_{DDC}$	$V_{GS} = 18\text{ V}$	$T_c = 25\text{ °C}$	89	A
			$T_c = 100\text{ °C}$	63	
Peak drain current, $t_p$ limited by $T_{vj(max)}$	$I_{DM}$	$V_{GS} = 18\text{ V}$	189	A	
Gate-source voltage, max. transient voltage <sup>1)</sup>	$V_{GS}$	$t_p \leq 0.5\ \mu\text{s}$ , $D < 0.01$	-10/23	V	
Gate-source voltage, max. static voltage	$V_{GS}$		-7/20	V	
Power dissipation, limited by $T_{vj(max)}$	$P_{tot}$	$T_c = 25\text{ °C}$	576	W	
		$T_c = 100\text{ °C}$	288		

1) **Important note:** The selection of positive and negative gate-source voltages impacts the long-term behavior of the device. The design guidelines described in Application Note AN2018-09 must be considered to ensure sound operation of the device over the planned lifetime.

**Table 3** Recommended values

Parameter	Symbol	Note or test condition	Values	Unit
Recommended turn-on gate voltage	$V_{GS(on)}$		15...18	V
Recommended turn-off gate voltage	$V_{GS(off)}$		-5...0	V

**Table 4** Characteristic values

Parameter	Symbol	Note or test condition	Values			Unit	
			Min.	Typ.	Max.		
Drain-source on-state resistance	$R_{DS(on)}$	$I_D = 40\text{ A}$	$T_{vj} = 25\text{ °C}$ , $V_{GS(on)} = 18\text{ V}$		24	33	mΩ
			$T_{vj} = 100\text{ °C}$ , $V_{GS(on)} = 18\text{ V}$		41		
			$T_{vj} = 175\text{ °C}$ , $V_{GS(on)} = 18\text{ V}$		72		
			$T_{vj} = 25\text{ °C}$ , $V_{GS(on)} = 15\text{ V}$		27	35	
Gate-source threshold voltage	$V_{GS(th)}$	$I_D = 24\text{ mA}$ , $V_{DS} = V_{GS}$ (tested after 1 ms pulse at $V_{GS} = 20\text{ V}$ )	$T_{vj} = 25\text{ °C}$	3.5	4.5	5.5	V
			$T_{vj} = 175\text{ °C}$		3.6		
Zero gate-voltage drain current	$I_{DSS}$	$V_{DS} = 2000\text{ V}$ , $V_{GS} = 0\text{ V}$	$T_{vj} = 25\text{ °C}$			400	μA
			$T_{vj} = 175\text{ °C}$		10		
Gate leakage current	$I_{GSS}$	$V_{DS} = 0\text{ V}$	$V_{GS} = 23\text{ V}$			100	nA
			$V_{GS} = -10\text{ V}$			-100	
Forward transconductance	$g_{fs}$	$I_D = 40\text{ A}$ , $V_{DS} = 20\text{ V}$		20			S
Internal gate resistance	$R_{G,int}$	$f = 100\text{ kHz}$ , $V_{AC} = 25\text{ mV}$		6			Ω
Input capacitance	$C_{iss}$	$V_{DD} = 1200\text{ V}$ , $V_{GS} = 0\text{ V}$ , $f = 100\text{ kHz}$ , $V_{AC} = 25\text{ mV}$		4850			pF
Output capacitance	$C_{oss}$	$V_{DD} = 1200\text{ V}$ , $V_{GS} = 0\text{ V}$ , $f = 100\text{ kHz}$ , $V_{AC} = 25\text{ mV}$		161			pF
Reverse transfer capacitance	$C_{rss}$	$V_{DD} = 1200\text{ V}$ , $V_{GS} = 0\text{ V}$ , $f = 100\text{ kHz}$ , $V_{AC} = 25\text{ mV}$		11			pF
$C_{oss}$ stored energy	$E_{oss}$	$V_{DD} = 1200\text{ V}$ , $V_{GS} = 0\text{ V}$ , $f = 100\text{ kHz}$ , $V_{AC} = 25\text{ mV}$		109			μJ
Total gate charge	$Q_G$	$V_{DD} = 1200\text{ V}$ , $I_D = 40\text{ A}$ , $V_{GS} = -2/18\text{ V}$ , turn-on pulse		137			nC
Plateau gate charge	$Q_{GS(pl)}$	$V_{DD} = 1200\text{ V}$ , $I_D = 40\text{ A}$ , $V_{GS} = -2/18\text{ V}$ , turn-on pulse		38			nC
Gate-to-drain charge	$Q_{GD}$	$V_{DD} = 1200\text{ V}$ , $I_D = 40\text{ A}$ , $V_{GS} = -2/18\text{ V}$ , turn-on pulse		22			nC
Turn-on delay time	$t_{d(on)}$	$V_{DD} = 1200\text{ V}$ , $I_D = 40\text{ A}$ , $V_{GS} = -2/18\text{ V}$ , $R_{GS(on)} = 2\text{ Ω}$ , $R_{GS(off)} = 2\text{ Ω}$ , $L_\sigma = 15\text{ nH}$ , diode: body diode at $V_{GS} = -2\text{ V}$	$T_{vj} = 25\text{ °C}$		19		ns
			$T_{vj} = 175\text{ °C}$		23		

(table continues...)

**Table 4 (continued) Characteristic values**

Parameter	Symbol	Note or test condition	Values			Unit
			Min.	Typ.	Max.	
Rise time	$t_r$	$V_{DD} = 1200\text{ V}, I_D = 40\text{ A},$ $V_{GS} = -2/18\text{ V},$ $R_{GS(on)} = 2\ \Omega,$ $R_{GS(off)} = 2\ \Omega, L_\sigma = 15\text{ nH},$ diode: body diode at $V_{GS} = -2\text{ V}$	$T_{vj} = 25\text{ }^\circ\text{C}$		11	ns
			$T_{vj} = 175\text{ }^\circ\text{C}$		14	
Turn-off delay time	$t_{d(off)}$	$V_{DD} = 1200\text{ V}, I_D = 40\text{ A},$ $V_{GS} = -2/18\text{ V},$ $R_{GS(on)} = 2\ \Omega,$ $R_{GS(off)} = 2\ \Omega, L_\sigma = 15\text{ nH},$ diode: body diode at $V_{GS} = -2\text{ V}$	$T_{vj} = 25\text{ }^\circ\text{C}$		40	ns
			$T_{vj} = 175\text{ }^\circ\text{C}$		58	
Fall time	$t_f$	$V_{DD} = 1200\text{ V}, I_D = 40\text{ A},$ $V_{GS} = -2/18\text{ V},$ $R_{GS(on)} = 2\ \Omega,$ $R_{GS(off)} = 2\ \Omega, L_\sigma = 15\text{ nH},$ diode: body diode at $V_{GS} = -2\text{ V}$	$T_{vj} = 25\text{ }^\circ\text{C}$		16	ns
			$T_{vj} = 175\text{ }^\circ\text{C}$		18	
Turn-on energy	$E_{on}$	$V_{DD} = 1200\text{ V}, I_D = 40\text{ A},$ $V_{GS} = -2/18\text{ V},$ $R_{GS(on)} = 2\ \Omega,$ $R_{GS(off)} = 2\ \Omega, L_\sigma = 15\text{ nH},$ diode: body diode at $V_{GS} = -2\text{ V}$	$T_{vj} = 25\text{ }^\circ\text{C}$		1150	$\mu\text{J}$
			$T_{vj} = 175\text{ }^\circ\text{C}$		2140	
Turn-off energy	$E_{off}$	$V_{DD} = 1200\text{ V}, I_D = 40\text{ A},$ $V_{GS} = -2/18\text{ V},$ $R_{GS(on)} = 2\ \Omega,$ $R_{GS(off)} = 2\ \Omega, L_\sigma = 15\text{ nH},$ diode: body diode at $V_{GS} = -2\text{ V}$	$T_{vj} = 25\text{ }^\circ\text{C}$		400	$\mu\text{J}$
			$T_{vj} = 175\text{ }^\circ\text{C}$		435	
Total switching energy	$E_{tot}$	$V_{DD} = 1200\text{ V}, I_D = 40\text{ A},$ $V_{GS} = -2/18\text{ V},$ $R_{GS(on)} = 2\ \Omega,$ $R_{GS(off)} = 2\ \Omega, L_\sigma = 15\text{ nH},$ diode: body diode at $V_{GS} = -2\text{ V}$	$T_{vj} = 25\text{ }^\circ\text{C}$		2100	$\mu\text{J}$
			$T_{vj} = 175\text{ }^\circ\text{C}$		3675	
Virtual junction temperature	$T_{vj}$			-55	175	$^\circ\text{C}$

*Note:* The chip technology was characterized up to 100 kV/ $\mu\text{s}$ . The measured  $dV/dt$  was limited by measurement test setup and package.

Dynamic test circuit see Fig. F.

### 3 Body diode (MOSFET)

**Table 5** Maximum rated values

Parameter	Symbol	Note or test condition	Values	Unit	
Drain-source voltage	$V_{DSS}$	$T_{vj} \geq 25\text{ °C}$	2000	V	
Continuous reverse drain current for $R_{th(j-c,max)}$ , limited by $T_{vj(max)}$	$I_{SDC}$	$V_{GS} = 0\text{ V}$	$T_c = 25\text{ °C}$	91	A
			$T_c = 100\text{ °C}$	69	
Peak reverse drain current, $t_p$ limited by $T_{vj(max)}$	$I_{SM}$	$V_{GS} = 0\text{ V}$	128	A	

**Table 6** Characteristic values

Parameter	Symbol	Note or test condition	Values			Unit	
			Min.	Typ.	Max.		
Drain-source reverse voltage	$V_{SD}$	$I_{SD} = 40\text{ A}, V_{GS} = 0\text{ V}$	$T_{vj} = 25\text{ °C}$		3.7	5.5	V
			$T_{vj} = 100\text{ °C}$		3.6		
			$T_{vj} = 175\text{ °C}$		3.5		
MOSFET forward recovery charge	$Q_{fr}$	$V_{DD} = 1200\text{ V}, I_{SD} = 40\text{ A}, V_{GS} = -2\text{ V}, R_{GS(on)} = 2\text{ }\Omega, Q_{fr}$ includes also $Q_C$	$T_{vj} = 25\text{ °C}$		1000		nC
			$T_{vj} = 175\text{ °C}$		1975		
MOSFET peak forward recovery current	$I_{frm}$	$V_{DD} = 1200\text{ V}, I_{SD} = 40\text{ A}, V_{GS} = -2\text{ V}, di_{SD}/dt = 1500\text{ A}/\mu\text{s}, Q_{fr}$ includes also $Q_C$	$T_{vj} = 25\text{ °C}$		27		A
			$T_{vj} = 175\text{ °C}$		32		
MOSFET forward recovery energy	$E_{fr}$	$V_{DD} = 1200\text{ V}, I_{SD} = 40\text{ A}, V_{GS} = -2\text{ V}, R_{GS(on)} = 2\text{ }\Omega, Q_{fr}$ includes also $Q_C$	$T_{vj} = 25\text{ °C}$		550		$\mu\text{J}$
			$T_{vj} = 175\text{ °C}$		1100		
Virtual junction temperature	$T_{vj}$		-55		175	$\text{°C}$	

## 4 Characteristics diagrams

### Reverse bias safe operating area (RBSOA)

$$I_{DS} = f(V_{DS})$$

$$T_{vj} \leq 175\text{ °C}, V_{GS} = 0/18\text{ V}, T_c = 25\text{ °C}$$

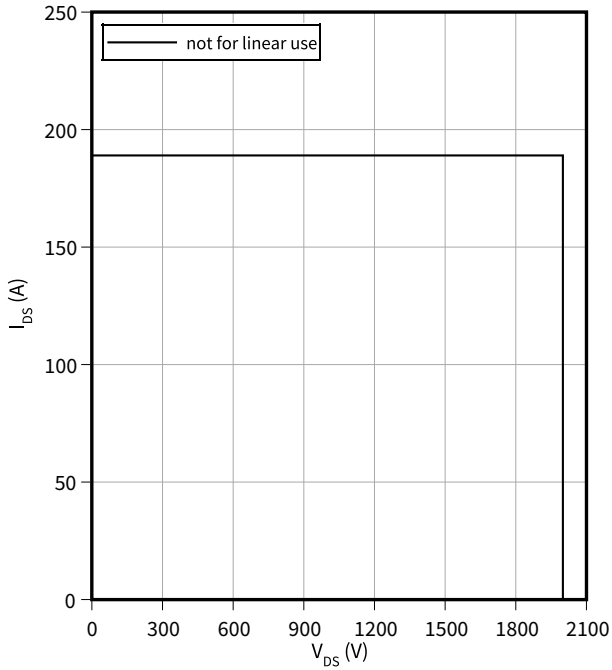

### Power dissipation as a function of case temperature limited by bond wire

$$P_{tot} = f(T_c)$$

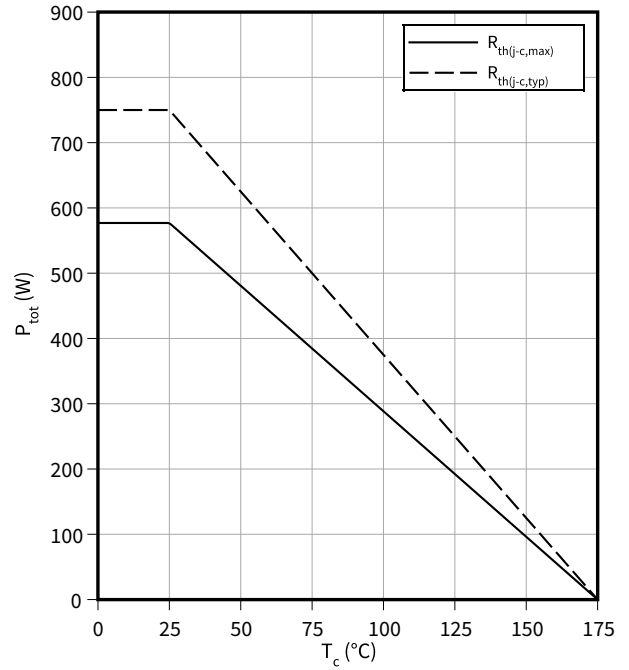

### Maximum DC drain to source current as a function of case temperature limited by bond wire

$$I_{DS} = f(T_c)$$

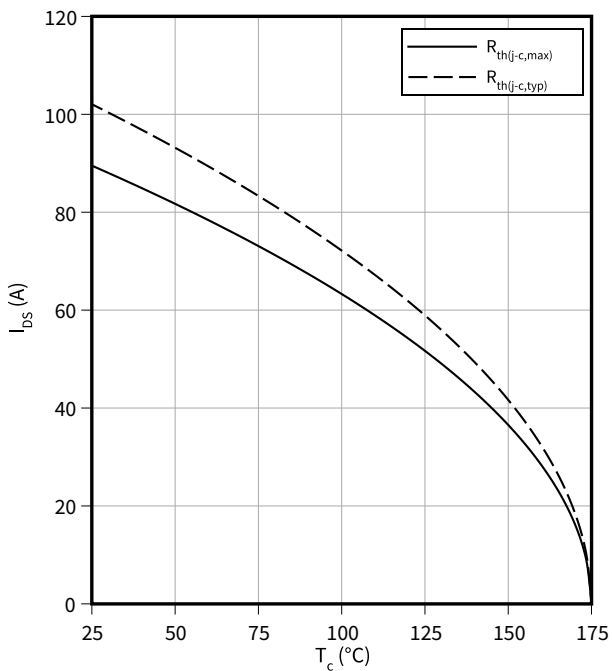

### Maximum source to drain current as a function of case temperature limited by bond wire

$$I_{SD} = f(T_c)$$

$$V_{GS} = 0\text{ V}$$

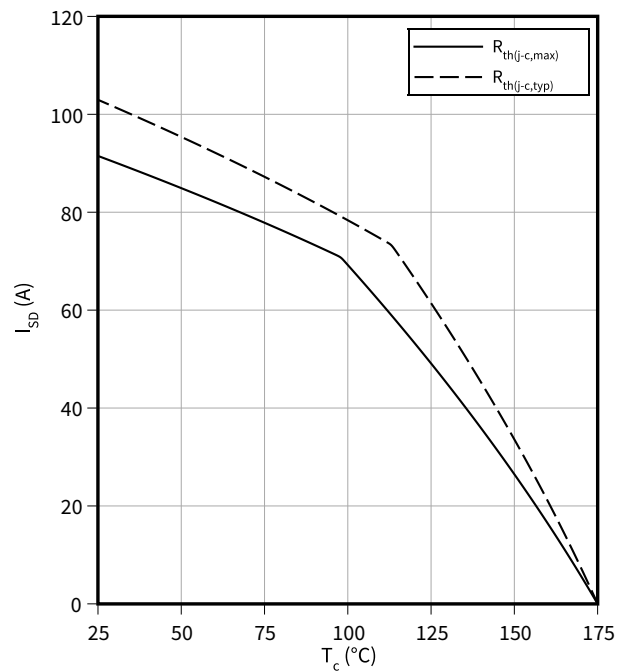

4 Characteristics diagrams

**Typical transfer characteristic**

$I_{DS} = f(V_{GS})$   
 $V_{DS} = 20\text{ V}, t_p = 20\ \mu\text{s}$

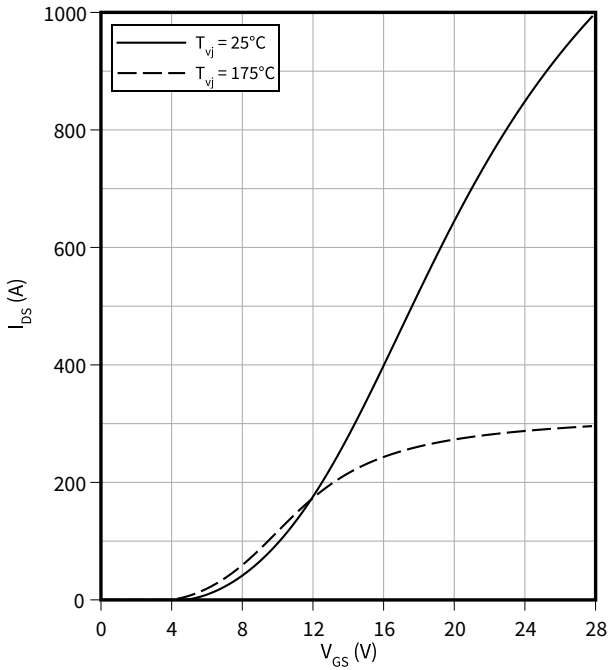

**Typical gate-source threshold voltage as a function of junction temperature**

$V_{GS(th)} = f(T_{vj})$   
 $I_D = 24\text{ mA}$

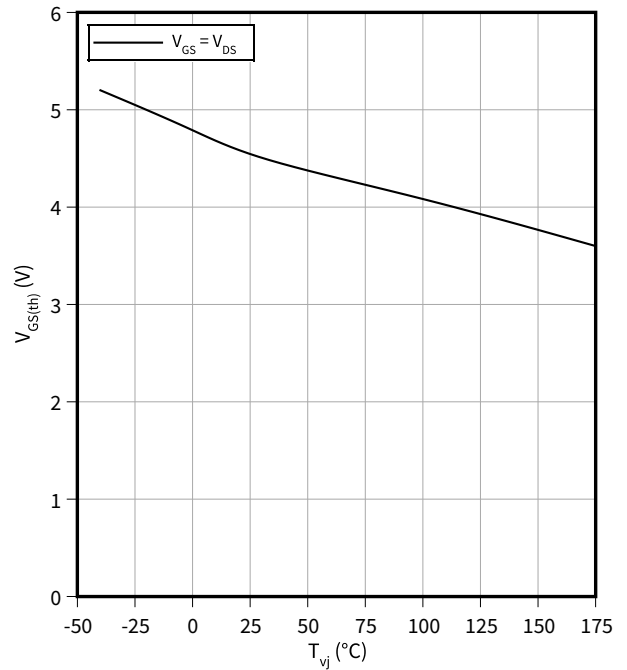

**Typical output characteristic,  $V_{GS}$  as parameter**

$I_{DS} = f(V_{DS})$   
 $T_{vj} = 25\ ^\circ\text{C}, t_p = 20\ \mu\text{s}$

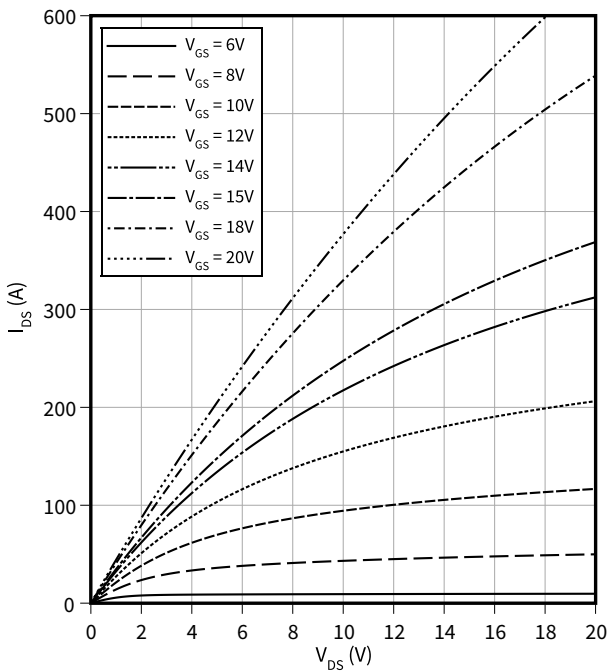

**Typical output characteristic,  $V_{GS}$  as parameter**

$I_{DS} = f(V_{DS})$   
 $T_{vj} = 175\ ^\circ\text{C}, t_p = 20\ \mu\text{s}$

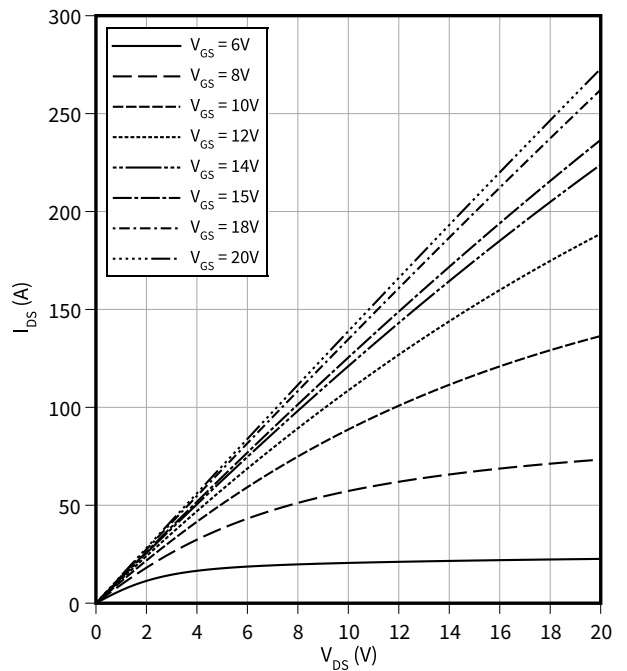



4 Characteristics diagrams

**Typical on-state resistance as a function of junction temperature**

$R_{DS(on)} = f(T_{vj})$   
 $I_D = 40\text{ A}$

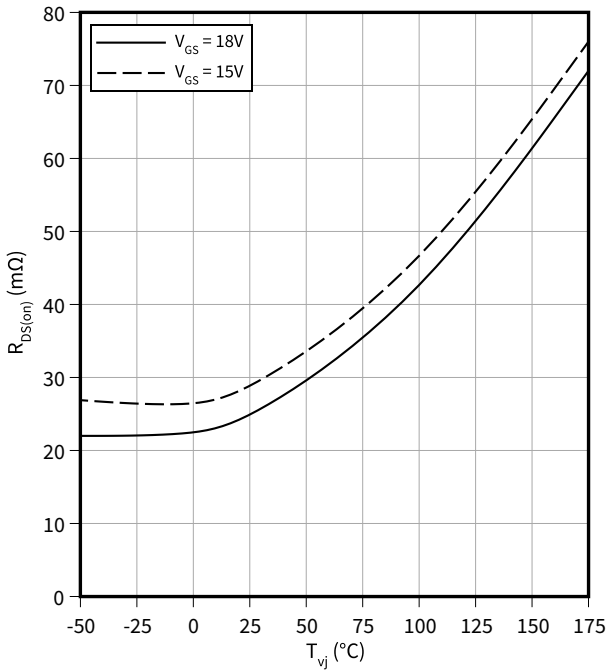

**Typical gate charge**

$V_{GS} = f(Q_G)$   
 $I_D = 40\text{ A}, V_{DS} = 1200\text{ V}$

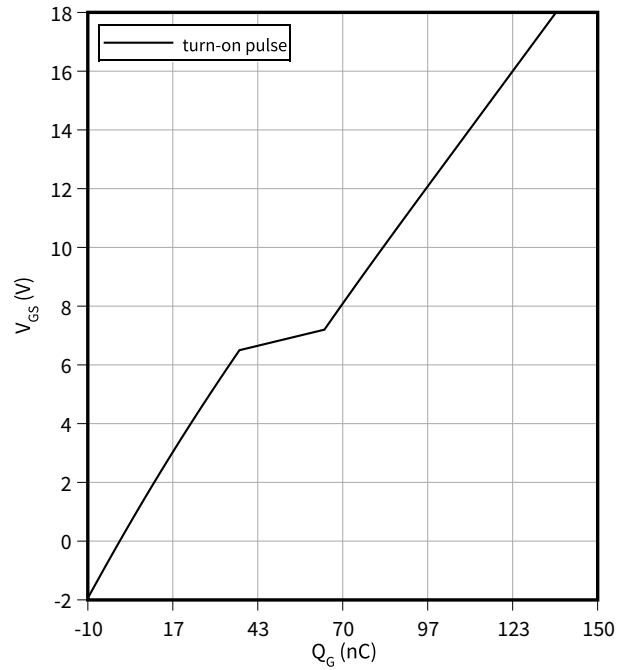

**Typical capacitance as a function of drain-source voltage**

$C = f(V_{DS})$   
 $f = 100\text{ kHz}, V_{GS} = 0\text{ V}$

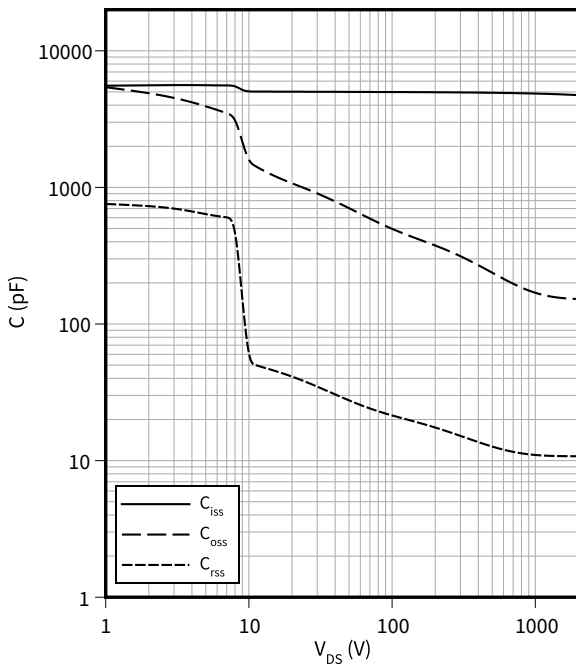

**Typical reverse drain voltage as function of junction temperature**

$V_{SD} = f(T_{vj})$   
 $I_{SD} = 40\text{ A}, V_{GS} = 0\text{ V}$

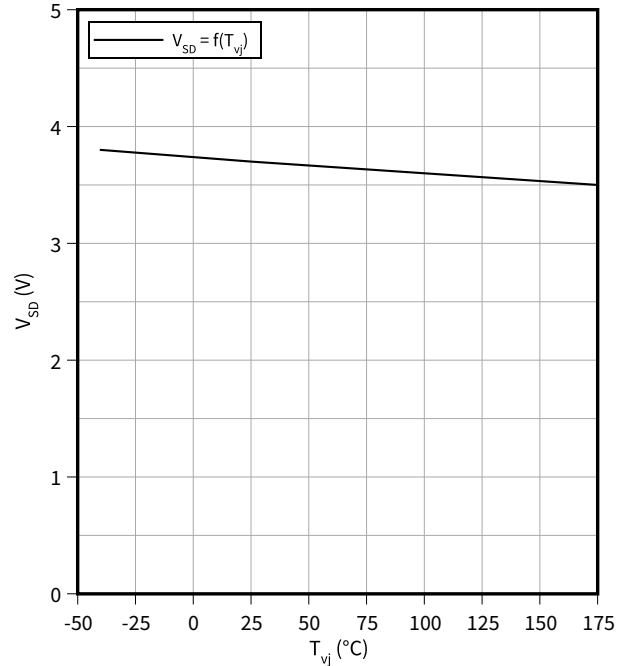

4 Characteristics diagrams

**Typical reverse drain current as function of reverse drain voltage,  $V_{GS}$  as parameter**

$I_{SD} = f(V_{SD})$   
 $T_{vj} = 25\text{ °C}$ ,  $t_p = 20\text{ }\mu\text{s}$

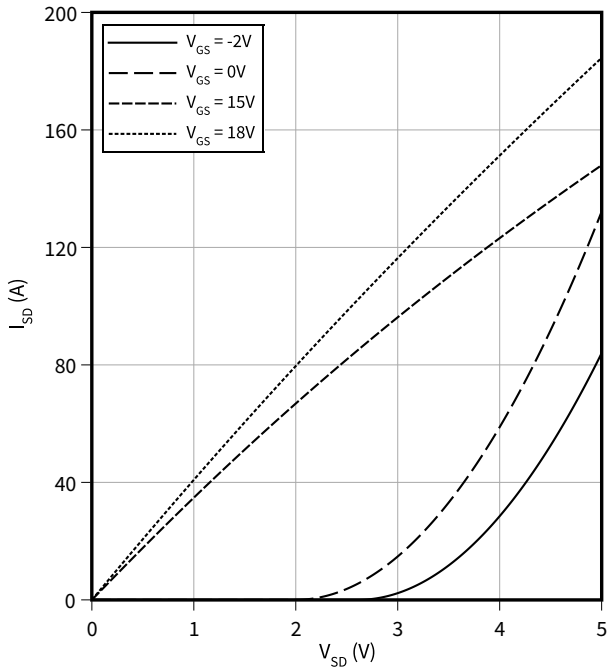

**Typical reverse drain current as function of reverse drain voltage,  $V_{GS}$  as parameter**

$I_{SD} = f(V_{SD})$   
 $T_{vj} = 175\text{ °C}$ ,  $t_p = 20\text{ }\mu\text{s}$

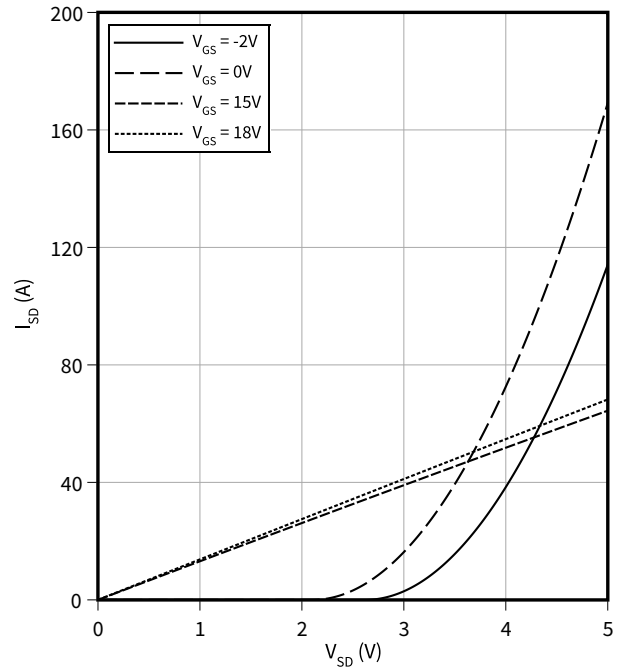

**Typical switching energy as a function of junction temperature, test circuit in Fig. F, 2nd device own body diode:  $V_{GS} = -2\text{ V}$**

$E = f(T_{vj})$   
 $V_{GS} = -2/18\text{ V}$ ,  $I_D = 40\text{ A}$ ,  $R_{G,ext} = 2\text{ }\Omega$ ,  $V_{DD} = 1200\text{ V}$

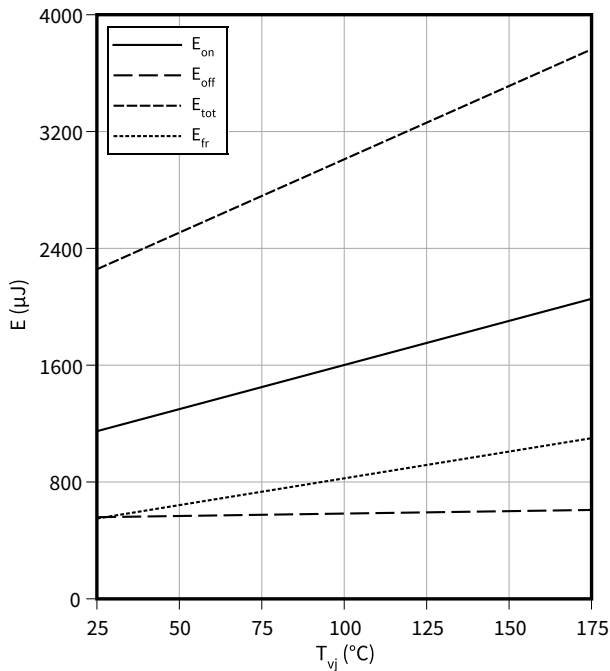

**Typical switching energy as a function of drain current, test circuit in Fig. F, 2nd device own body diode:  $V_{GS} = -2\text{ V}$**

$E = f(I_D)$   
 $V_{GS} = -2/18\text{ V}$ ,  $T_{vj} = 175\text{ °C}$ ,  $R_{G,ext} = 2\text{ }\Omega$ ,  $V_{DD} = 1200\text{ V}$

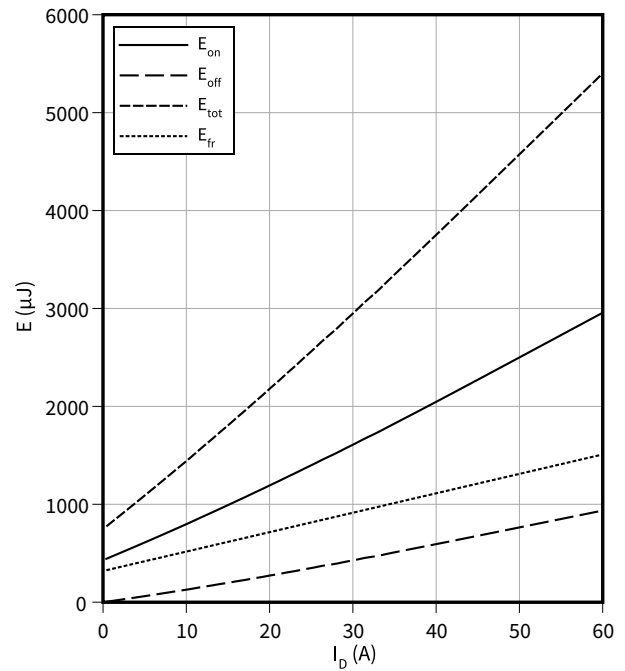

4 Characteristics diagrams

**Typical switching energy losses as a function of gate resistance, test circuit in Fig. F, 2nd device own body diode:  $V_{GS} = -2\text{ V}$**

$E = f(R_{G,ext})$

$V_{GS} = -2/18\text{ V}$ ,  $I_D = 40\text{ A}$ ,  $T_{vj} = 175\text{ °C}$ ,  $V_{DD} = 1200\text{ V}$

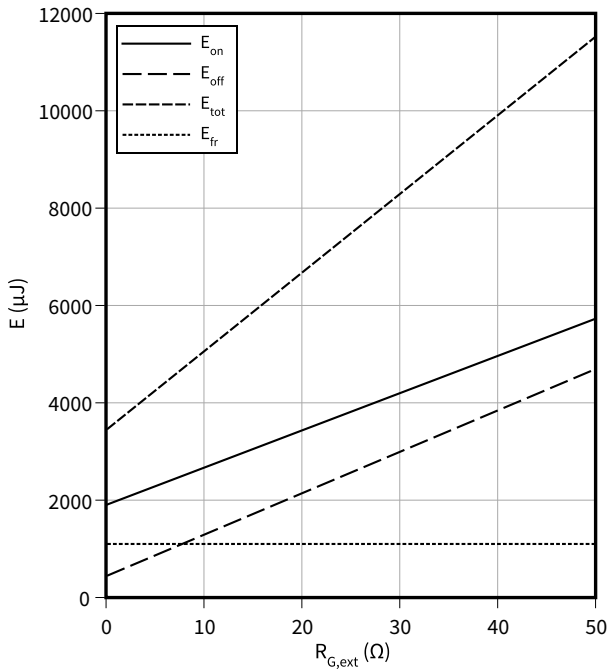

**Typical switching times as a function of gate resistance, test circuit in Fig. F, 2nd device own body diode:  $V_{GS} = -2\text{ V}$**

$t = f(R_{G,ext})$

$I_D = 40\text{ A}$ ,  $T_{vj} = 175\text{ °C}$ ,  $V_{GS} = -2/18\text{ V}$ ,  $V_{DD} = 1200\text{ V}$

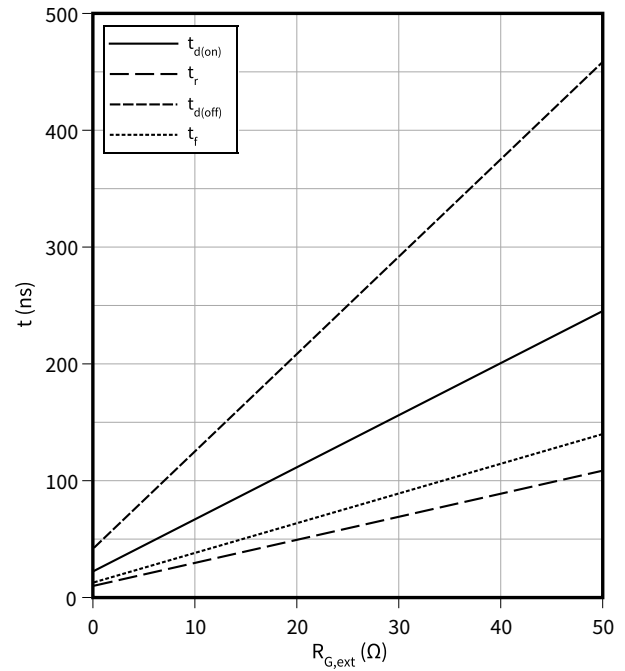

**Typical reverse recovery charge as a function of reverse drain current slope, test circuit in Fig. F, 2nd device own body diode:  $V_{GS} = -2\text{ V}$**

$Q_{fr} = f(di_{SD}/dt)$

$V_{GS} = -2/18\text{ V}$ ,  $I_{SD} = 40\text{ A}$ ,  $V_{DD} = 1200\text{ V}$

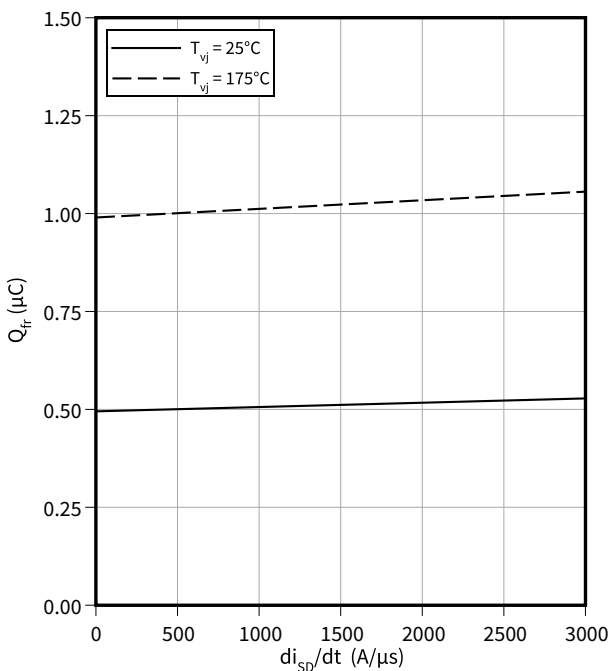

**Typical reverse recovery current as a function of reverse drain current slope, test circuit in Fig. F, 2nd device own body diode:  $V_{GS} = -2\text{ V}$**

$I_{frm} = f(di_{SD}/dt)$

$V_{GS} = -2/18\text{ V}$ ,  $I_{SD} = 40\text{ A}$ ,  $V_{DD} = 1200\text{ V}$

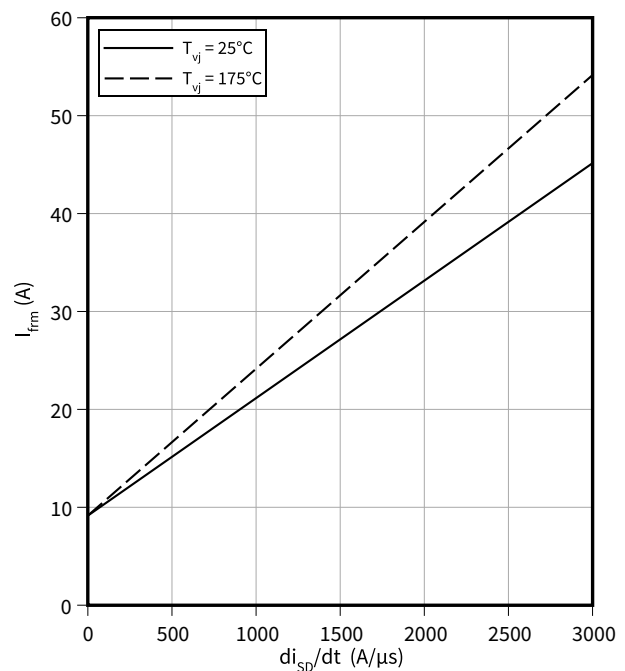

4 Characteristics diagrams

**Typical switching energy losses as a function of dead time / blanking time, test circuit in Fig. F, 2nd device own body diode:  $V_{GS} = -5\text{ V}$**

$$E = f(t_{\text{dead}})$$

$I_D = 40\text{ A}$ ,  $T_{vj} = 175\text{ °C}$ ,  $R_{G,\text{ext}} = 2\ \Omega$ ,  $V_{DD} = 1200\text{ V}$

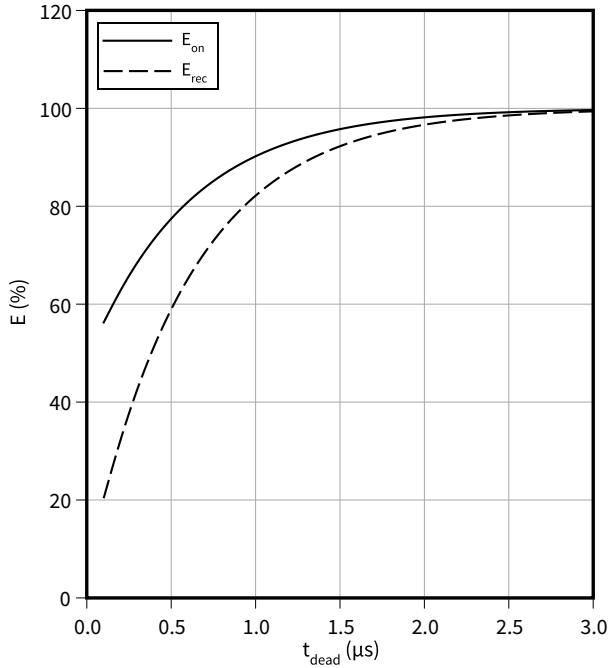

**Max. transient thermal impedance (MOSFET/diode)**

$$Z_{\text{th}(j-c),\text{max}} = f(t_p)$$

$$D = t_p/T$$

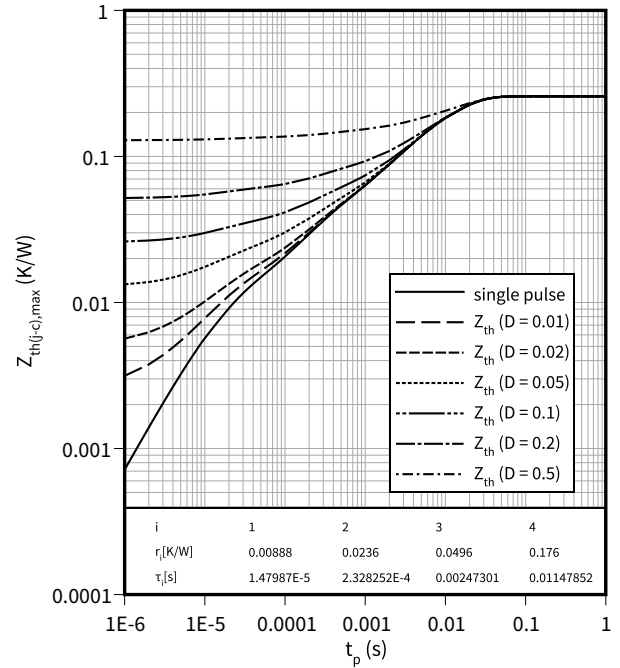

5 Package outlines

PG-T0247-4-PLUS-NT14

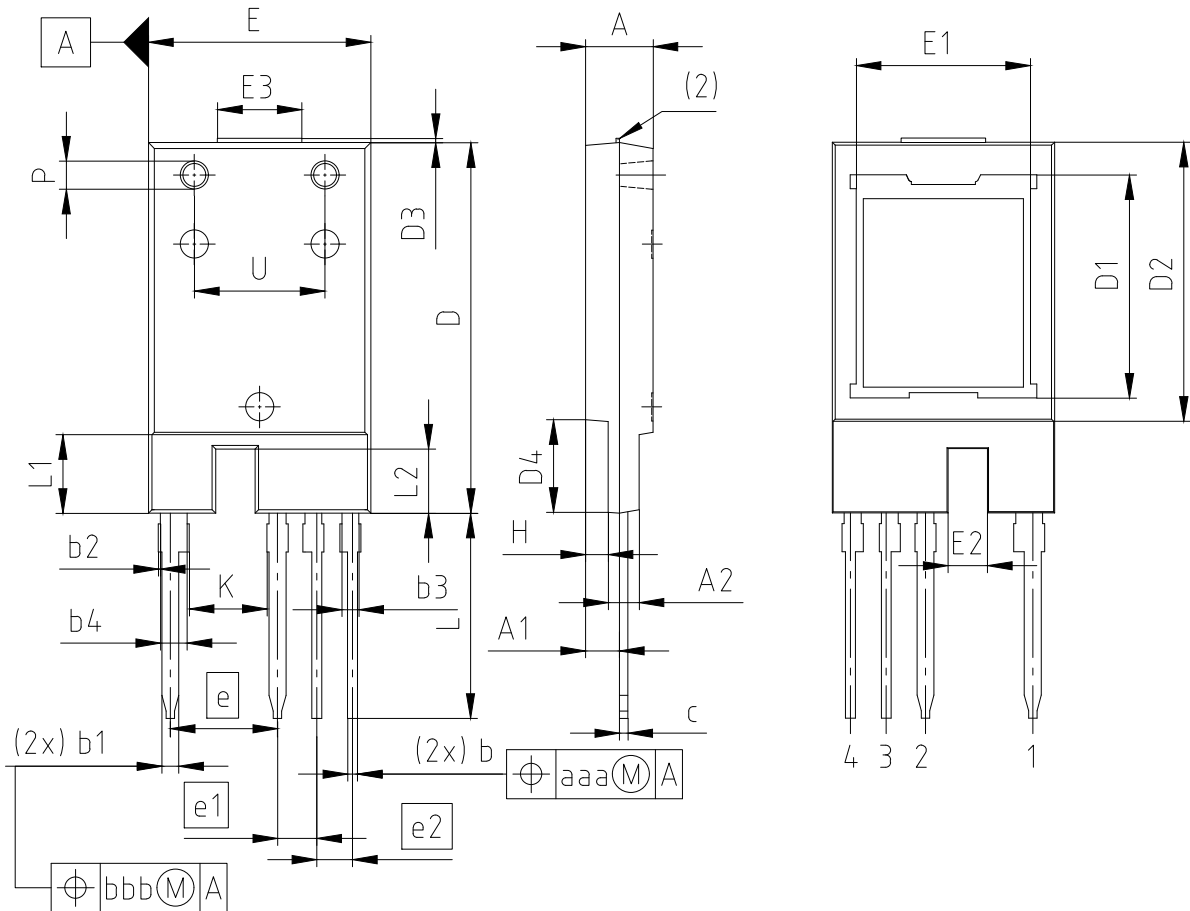

NOTES:  
(1) ALL METAL SURFACES TIN PLATED EXPECT AREA OF CUT  
(2) MOLD GATE PROTRUSION AFTER DEGATING

PACKAGE - GROUP NUMBER: **PG-T0247-4-U04**

DIMENSIONS	MILLIMETERS		DIMENSIONS	MILLIMETERS	
	MIN.	MAX.		MIN.	MAX.
<b>A</b>	4.65	4.95	<b>E1</b>	12.00	12.80
<b>A1</b>	2.16	2.66	<b>E2</b>	2.60	3.00
<b>A2</b>	2.00	2.40	<b>E3</b>	5.00	7.00
<b>b</b>	0.60	0.80	<b>e</b>	7.62	
<b>b1</b>	1.10	1.30	<b>e1</b>	2.79	
<b>b2</b>	---	0.15	<b>e2</b>	2.54	
<b>b3</b>	1.10	1.30	<b>H</b>	1.51	1.71
<b>b4</b>	1.70	2.10	<b>K</b>	5.50	---
<b>c</b>	0.50	0.70	<b>N</b>	4	
<b>D</b>	26.00	26.70	<b>L</b>	14.30	14.90
<b>D1</b>	15.50	16.30	<b>L1</b>	5.40	5.70
<b>D2</b>	19.40	20.20	<b>L2</b>	5.40	5.70
<b>D3</b>	---	0.50	<b>ØP</b>	1.75	2.25
<b>D4</b>	6.35	6.65	<b>U</b>	9.00	9.50
<b>E</b>	15.60	16.00	<b>aaa</b>	0.25	
			<b>bbb</b>	0.25	

Figure 1

## 6 Testing conditions

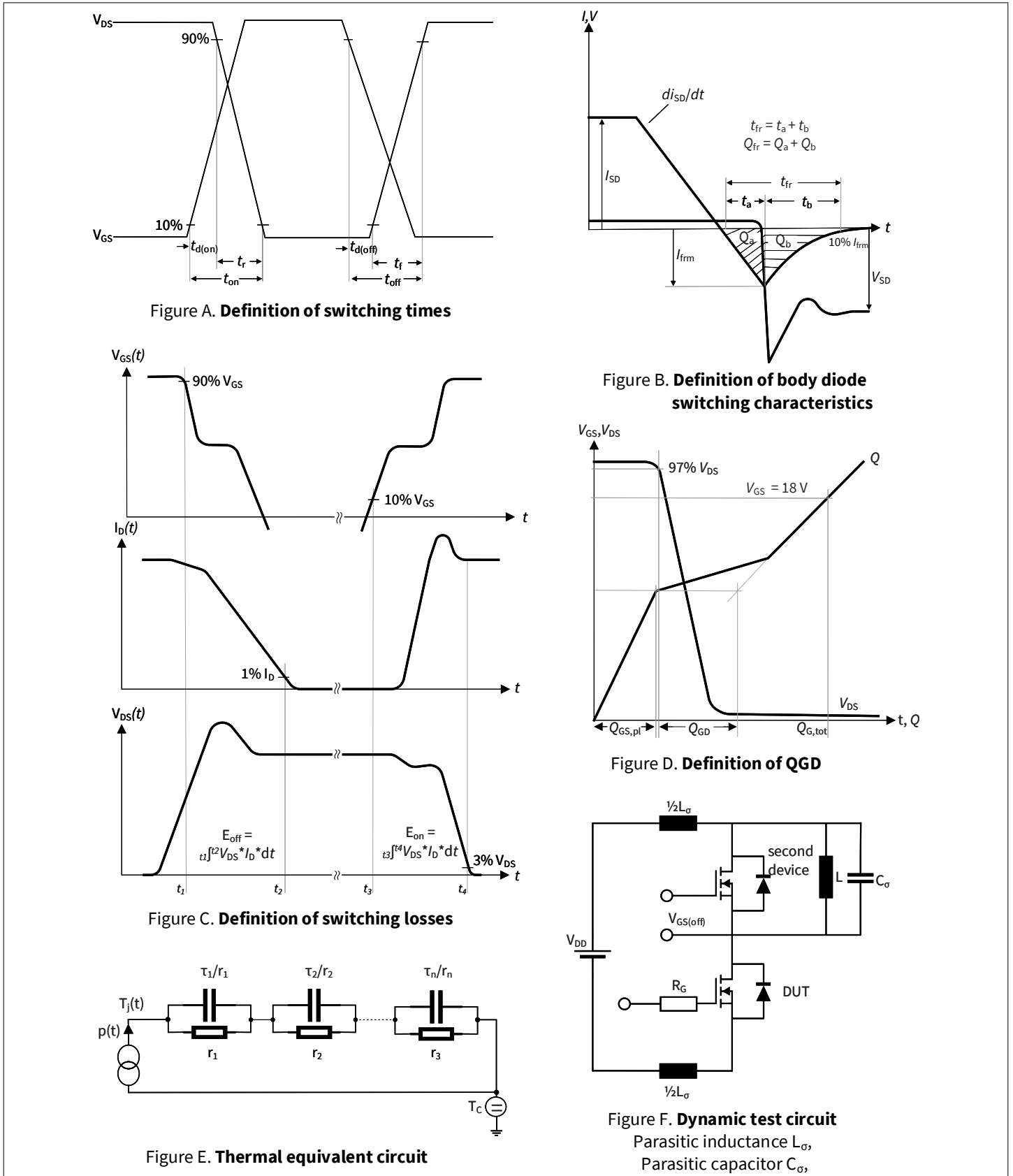

Figure 2

Revision history

## Revision history

Document revision	Date of release	Description of changes
0.10	2022-03-08	Preliminary datasheet
1.00	2022-10-04	Final datasheet
1.01	2022-10-06	Editorial changes
1.10	2023-01-16	Change of picture on page 1 Change of product outline drawing on page 13 Editorial changes

## Trademarks

All referenced product or service names and trademarks are the property of their respective owners.

**Edition 2023-01-16**

**Published by**

**Infineon Technologies AG**

**81726 Munich, Germany**

**© 2023 Infineon Technologies AG**

**All Rights Reserved.**

**Do you have a question about any aspect of this document?**

**Email: [erratum@infineon.com](mailto:erratum@infineon.com)**

**Document reference**

**IFX-ABD243-004**

## Important notice

The information given in this document shall in no event be regarded as a guarantee of conditions or characteristics ("Beschaffheitsgarantie").

With respect to any examples, hints or any typical values stated herein and/or any information regarding the application of the product, Infineon Technologies hereby disclaims any and all warranties and liabilities of any kind, including without limitation warranties of non-infringement of intellectual property rights of any third party.

In addition, any information given in this document is subject to customer's compliance with its obligations stated in this document and any applicable legal requirements, norms and standards concerning customer's products and any use of the product of Infineon Technologies in customer's applications.

The data contained in this document is exclusively intended for technically trained staff. It is the responsibility of customer's technical departments to evaluate the suitability of the product for the intended application and the completeness of the product information given in this document with respect to such application.

Please note that this product is not qualified according to the AEC Q100 or AEC Q101 documents of the Automotive Electronics Council.

## Warnings

Due to technical requirements products may contain dangerous substances. For information on the types in question please contact your nearest Infineon Technologies office.

Except as otherwise explicitly approved by Infineon Technologies in a written document signed by authorized representatives of Infineon Technologies, Infineon Technologies' products may not be used in any applications where a failure of the product or any consequences of the use thereof can reasonably be expected to result in personal injury.



单击下面可查看定价，库存，交付和生命周期等信息

[>>Infineon\(英飞凌\)](#)