

18V Low Current Consumption 500mA CMOS Voltage Regulator

General Description

The WR0514 series can provide 500mA output current and the maximum input voltage is 18V, the series is a high accuracy, low noise, high speed, low dropout CMOS Linear regulator with high ripple rejection. The devices offer a new level of cost-effective performance in the battery-powered equipments, such as RF applications and other systems requiring a quiet input voltage.

The WR0514 has the fold-back maximum short output current which depends on the output voltage. So the current limit functions both as a short circuit protection and as an output current limiter.

The WR0514 regulators are available in standard SOT23-3 package、SOT23-5 package and SOT89-3L Package. Standard products are Pb-free and Halogen-free.

Features

- Input Voltage: 2.5V to 18V
- Output Voltage: 1.2V to 5V
- Output Current: 500mA
- PSRR: 75dB@1KHz
- Dropout Voltage: 95mV @ $I_{OUT} = 100mA$
- Shut-down Current: $< 1\mu A$
- Quiescent Current: 3 μA Typ.
- Recommend Capacitor: 1 μF

Applications

- MP3/MP4 Players
- Cellphones, radiophone, digital cameras
- Bluetooth, wireless handsets
- Others portable electronics device

Typical Application

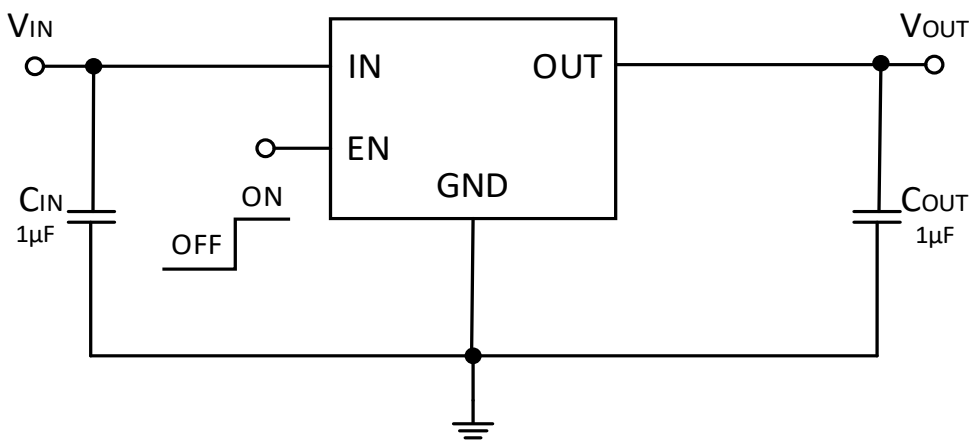

Pin Configuration

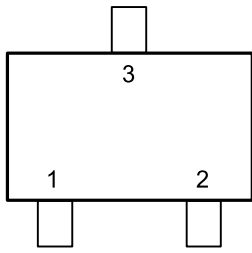

SOT23-3

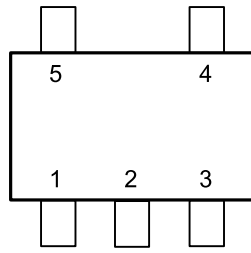

SOT23-5

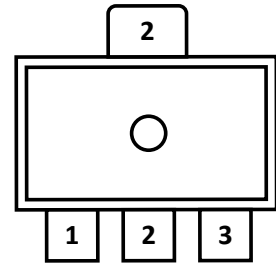

SOT89-3/L

Pin Description

Pin Number				Pin Name	Description
SOT23-3	SOT23-5	SOT89-3L	SOT89-3		
3	1	2	3	VIN	Input Voltage
1	2	1	2	GND	Ground
-	3	-	-	EN	Enable, Active High
-	4	-	-	NC	Not connect
2	5	3	1	VOUT	Output Voltage

Absolute Maximum Ratings

Parameter		Rating	Unit
Input voltage range		-0.3 ~ 18	V
EN Input voltage range		-0.3 ~ V _{IN}	V
Output voltage range		-0.3 ~ 5	V
Power Dissipation P _D @T _A = 25°C	SOT23-3 & SOT23-5	500	mW
	SOT89-3/L	625	mW
Thermal Resistance, θ _{JA}	SOT23-3 & SOT23-5	250	°C/W
	SOT89-3/L	200	°C/W
Junction Temperature		150	°C
Lead Temperature Range		260	°C
Storage Temperature Range		-40 ~ 125	°C
ESD Susceptibility	HBM	±3000	V

Recommended Operating Conditions

Parameter	Rating	Unit
Operating Supply voltage	2.5 ~ 18	V
Operating Temperature Range	-40 ~ 125	°C

Electrical Characteristics

($T_A=25\text{ }^\circ\text{C}$, $V_{IN}=V_{OUT}+1\text{V}$, $C_{IN}=C_{OUT}=1\mu\text{F}$, unless otherwise noted)

symbol	Parameter	Test Condition	Min	Typ	Max	Unit
V_{OUT}	Output Voltage	$V_{OUT} \leq 1.5\text{V}$, $V_{IN}=2.7\text{V}$, $I_{OUT}=1\text{mA}$	0.97 V_{OUT}	V_{OUT}	1.03 V_{OUT}	V
		$V_{OUT} > 1.5\text{V}$, $I_{OUT}=1\text{mA}$	0.98 V_{OUT}	V_{OUT}	1.02 V_{OUT}	
V_{DO}	Dropout Voltage ¹	$V_{OUT}=3.3\text{V}$, $I_{OUT}=100\text{mA}$		95		mV
I_{OUT}	Maximum Output Current ²	$V_{EN}=V_{IN}$	500			mA
LNR	Line Regulation	$V_{IN}=2.5\sim 18\text{V}$, $I_{OUT}=1\text{mA}$		0.01		%/V
LDR	Load Regulation	$V_{OUT}=3.3\text{V}$, $I_{OUT}=1\sim 500\text{mA}$		30		mV
I_Q	Quiescent Current	$V_{OUT}=3.3\text{V}$, $I_{OUT}=0\text{mA}$		3	5	μA
I_{SHDN}	Shut-down Current	$V_{EN} = 0\text{V}$		0.3	1	μA
I_{SHORT}	Short Current	$V_{EN}=V_{IN}$, V_{OUT} Short to GND		90		mA
$\frac{\Delta V_{OUT}}{\Delta T_A \times V_{OUT}}$	Output Voltage Temperature Coefficient	$I_{OUT}=10\text{mA}$, $-40^\circ\text{C} < T_A < 125^\circ\text{C}$		50		ppm
PSRR	Power Supply Ripple Rejection	$V_{IN}=(V_{OUT}+1\text{V})_{DC}+0.5\text{V}_{P-P}$ $F=1\text{KHz}$, $I_{OUT}=50\text{mA}$		75		dB
		$V_{IN}=(V_{OUT}+1\text{V})_{DC}+0.5\text{V}_{P-P}$ $F=10\text{KHz}$, $I_{OUT}=50\text{mA}$		45		
V_{NO}	Output Noise Voltage	10Hz to 100KHz, $C_{OUT}=1\mu\text{F}$, $I_{OUT}=10\text{mA}$		$27 \times V_{OUT}$		μV_{RMS}
V_{IH}	EN Logic High Voltage	$V_{IN}=5.5\text{V}$, $I_{OUT}=1\text{mA}$	1.2			V
V_{IL}	EN Logic Low Voltage	$V_{IN}=5.5\text{V}$, $I_{OUT}=0\text{mA}$			0.4	V
T_{SD}	Thermal Shutdown Threshold			150		$^\circ\text{C}$
ΔT_{SD}	Thermal Shutdown Hysteresis			15		$^\circ\text{C}$

Note1: The dropout voltage is defined as ($V_{IN}-V_{OUT}$) when V_{OUT} is 100mV below the target value of V_{OUT} .

Note2: Maximum output current is affected by the PCB layout, size of metal trace, the thermal conduction path between metal layers, ambient temperature and the other environment factors of system. Attention should be paid to the dropout voltage when $V_{IN} < V_{OUT} + V_{DROP}$.

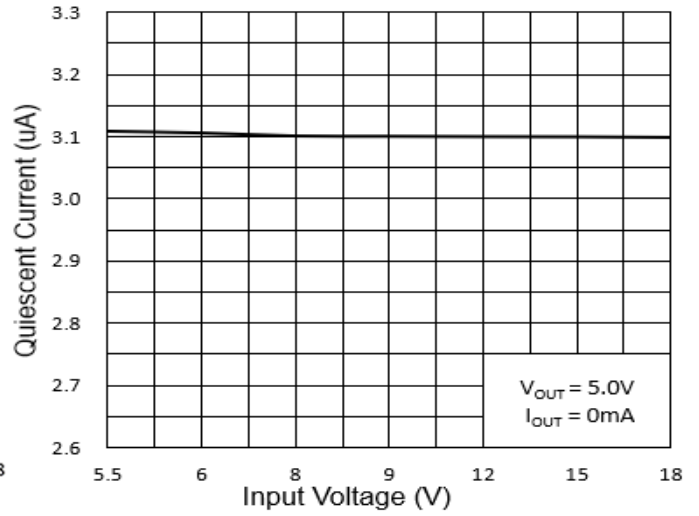
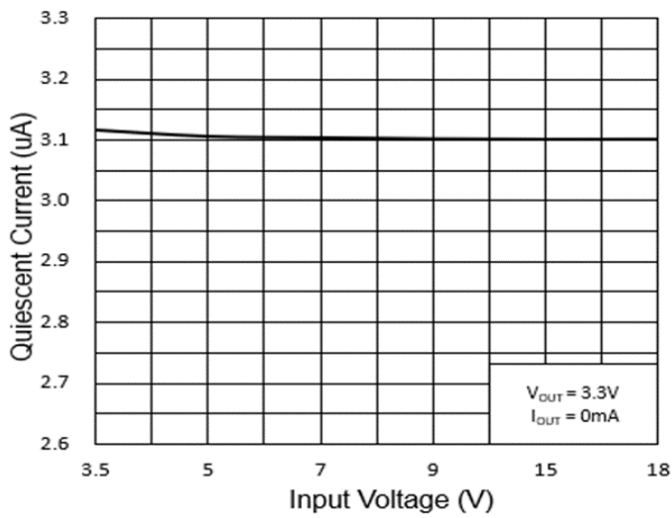
Typical Characteristics ($T_a=25^\circ\text{C}$, $V_{IN}=V_{OUT}+1\text{V}$, $C_{IN}=C_{OUT}=1\mu\text{F}$, unless otherwise noted)

Quiescent Current vs. Supply Voltage

Quiescent Current vs. Supply Voltage

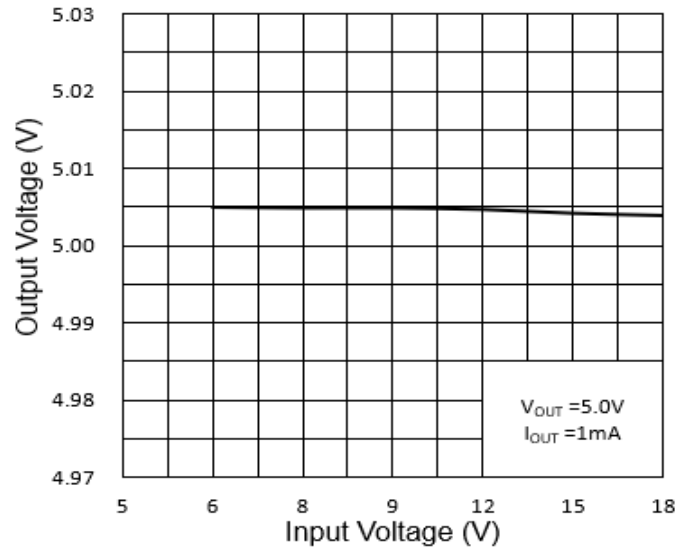
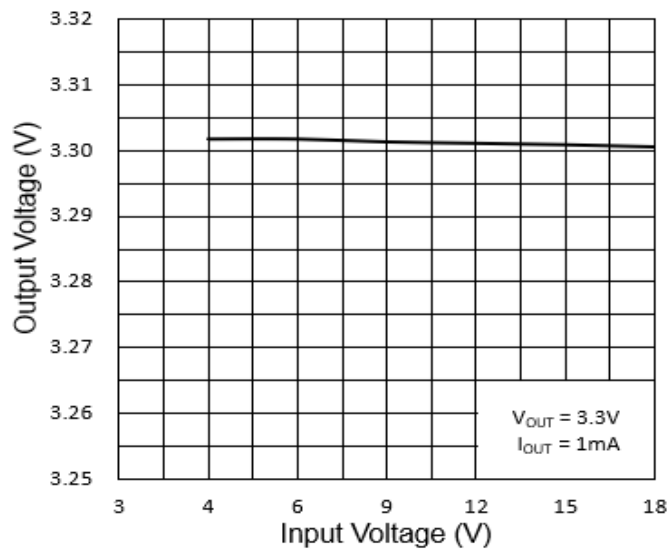

Output Voltage vs. Supply Voltage

Output Voltage vs. Supply Voltage

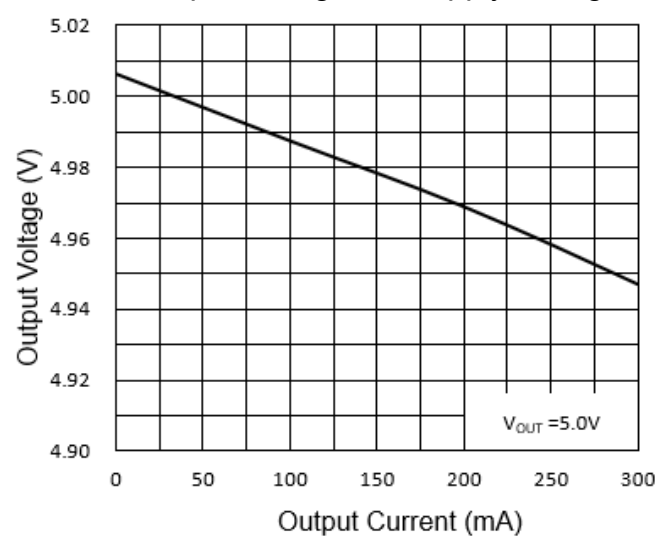
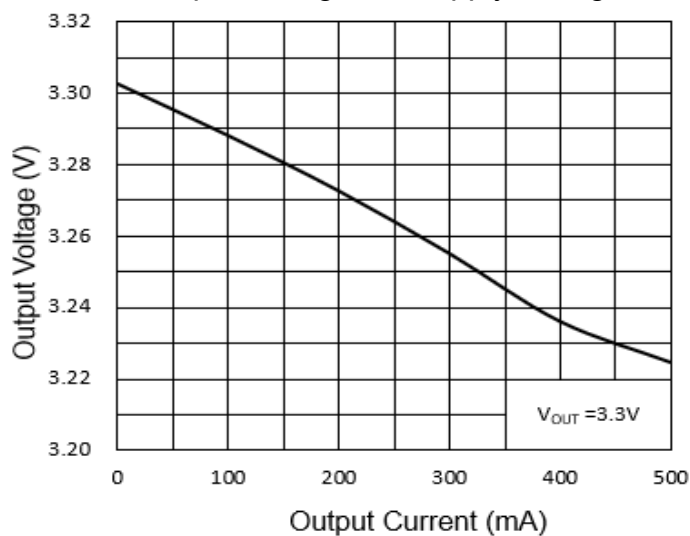

Output Voltage vs. Output Current

Output Voltage vs. Output Current

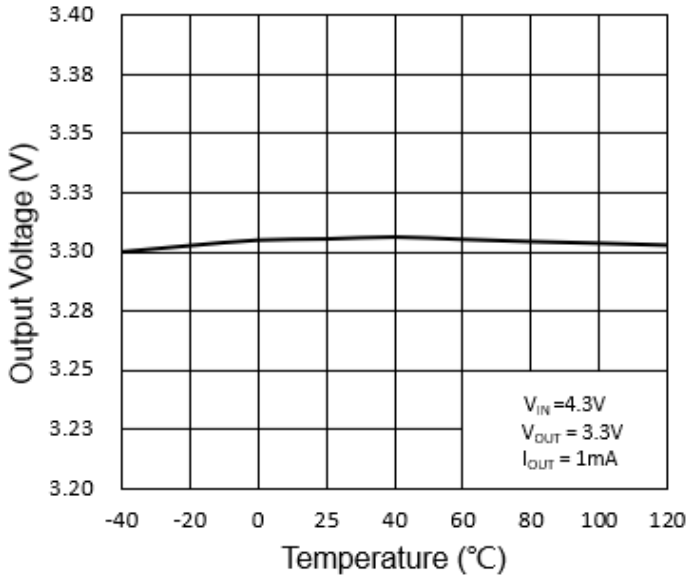

Output Voltage vs. Temperature

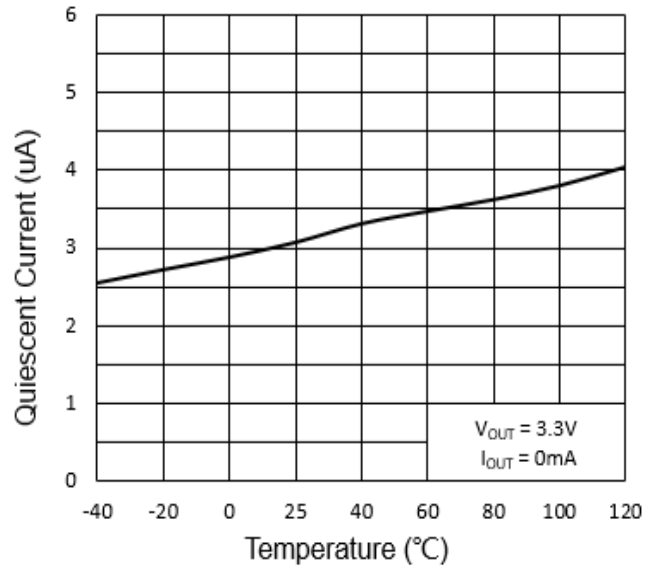

Quiescent Current vs. Temperature

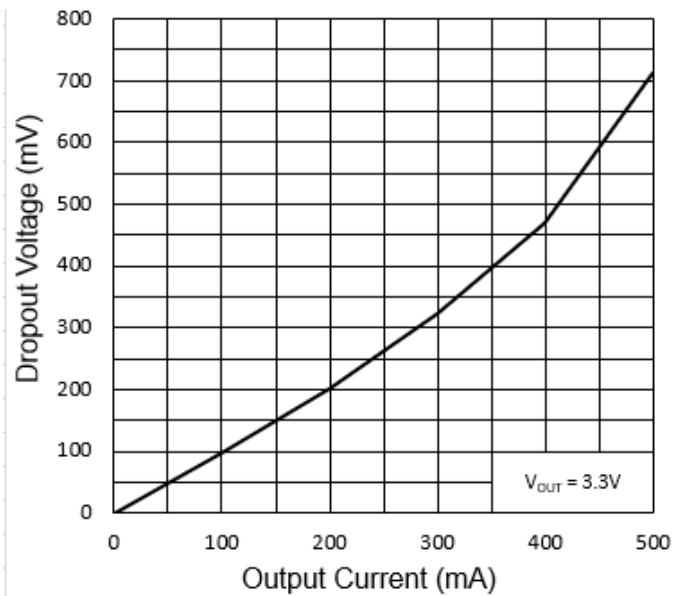

Dropout Voltage vs. Output Current

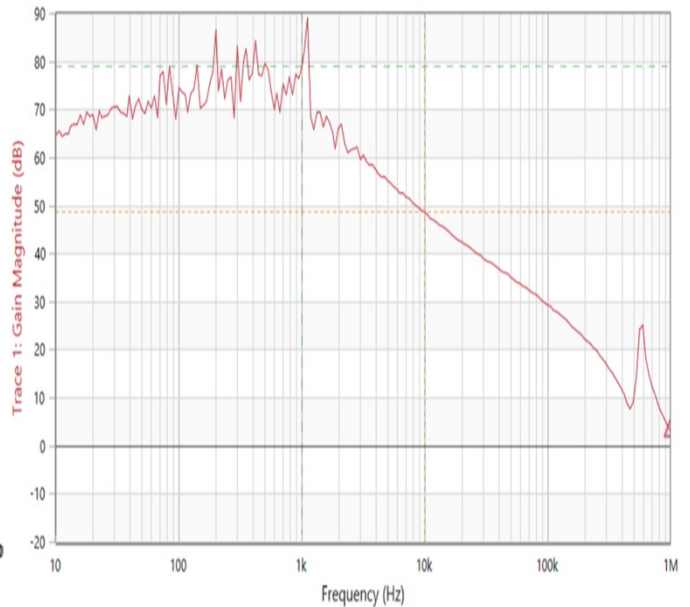

Power Supply Rejection Ratio vs. Frequency

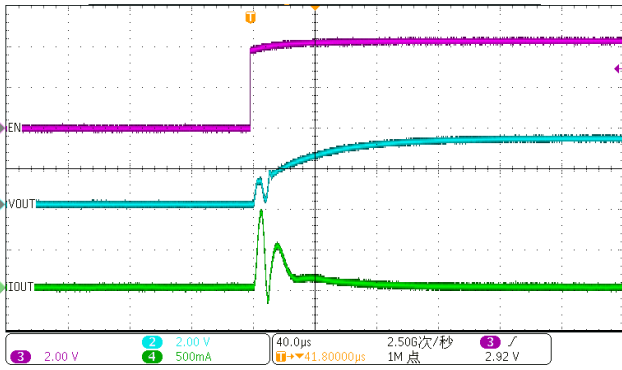

Soft Start from EN

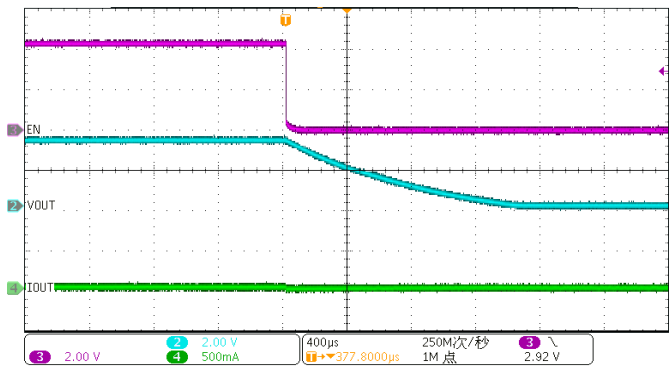

EN Shutdown

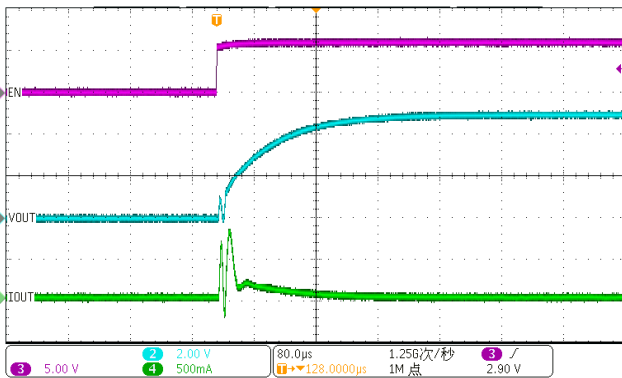

Soft Start from EN

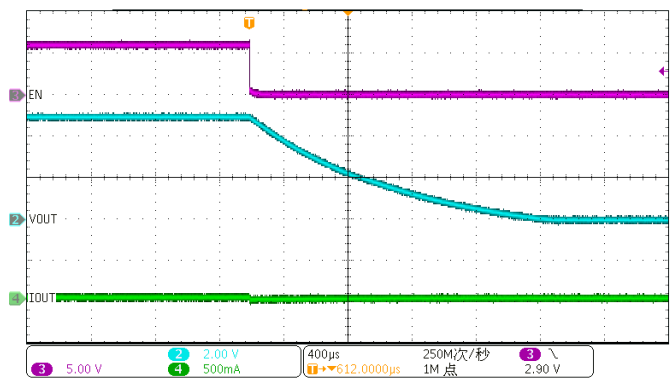

EN Shutdown

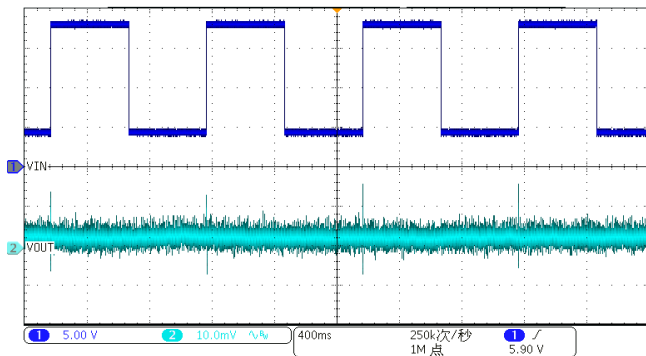

Line Transient

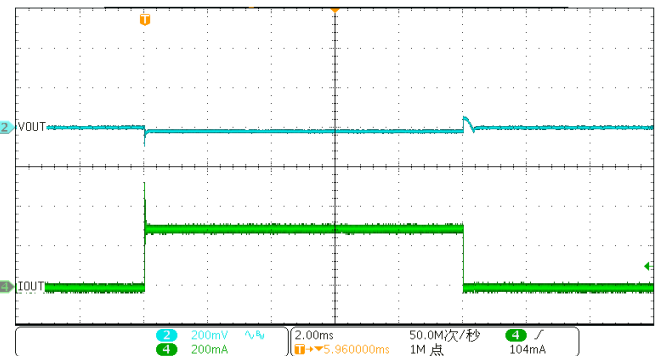

Load Transient

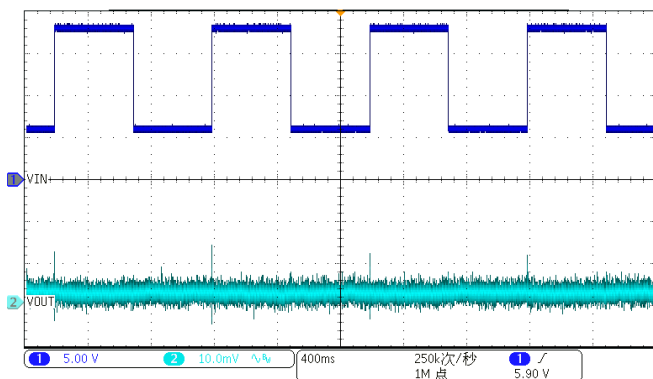

Line Transient

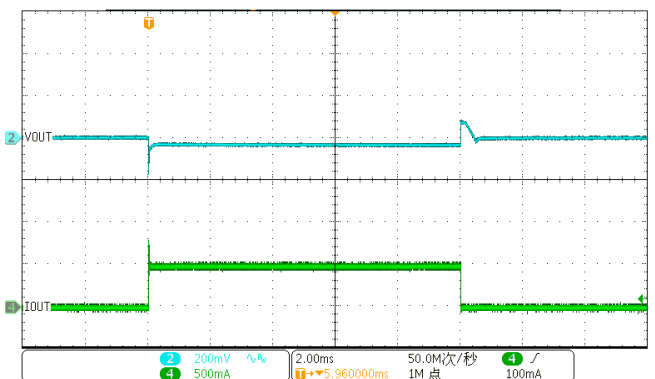

Load Transient

Block Diagram

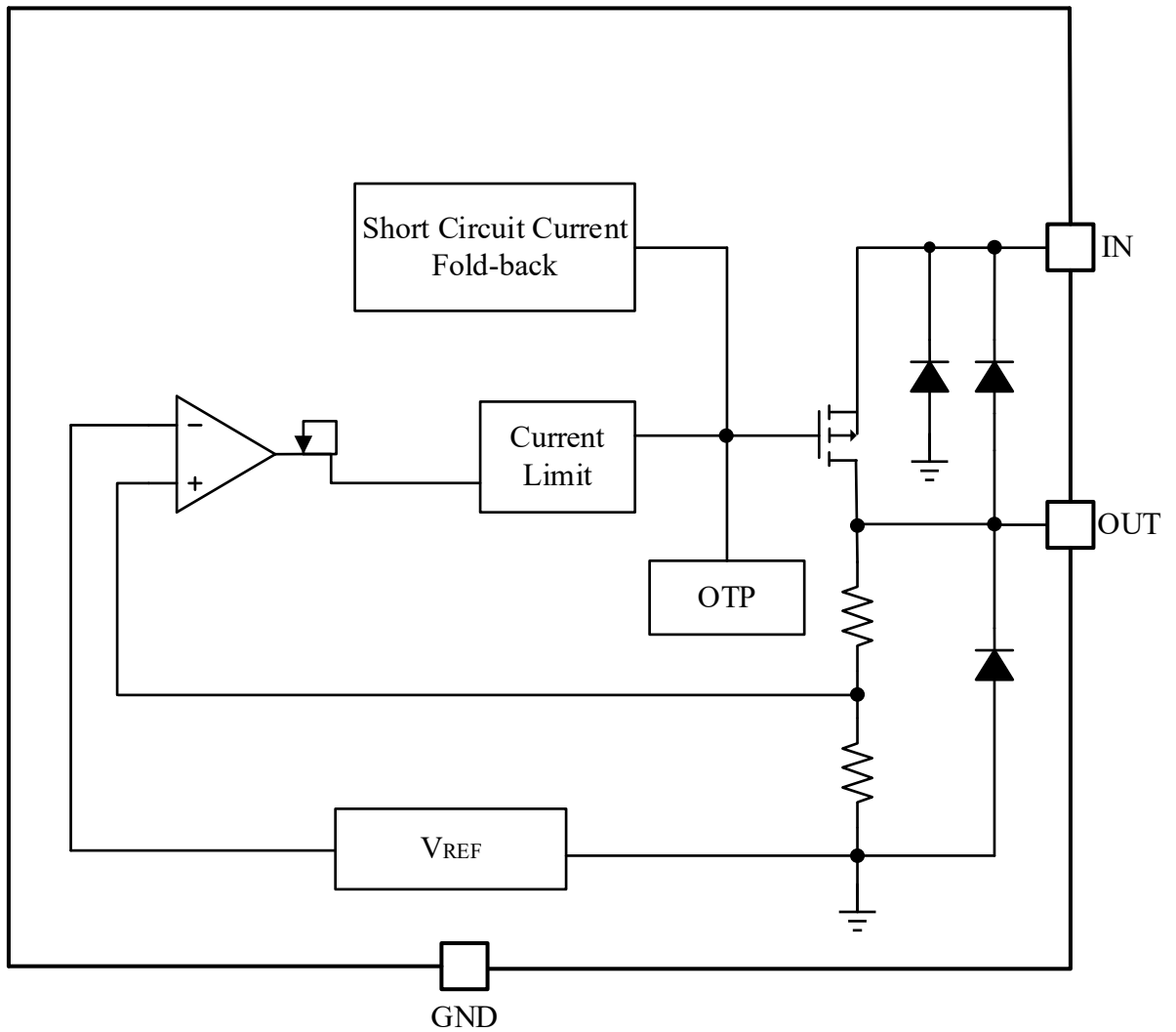

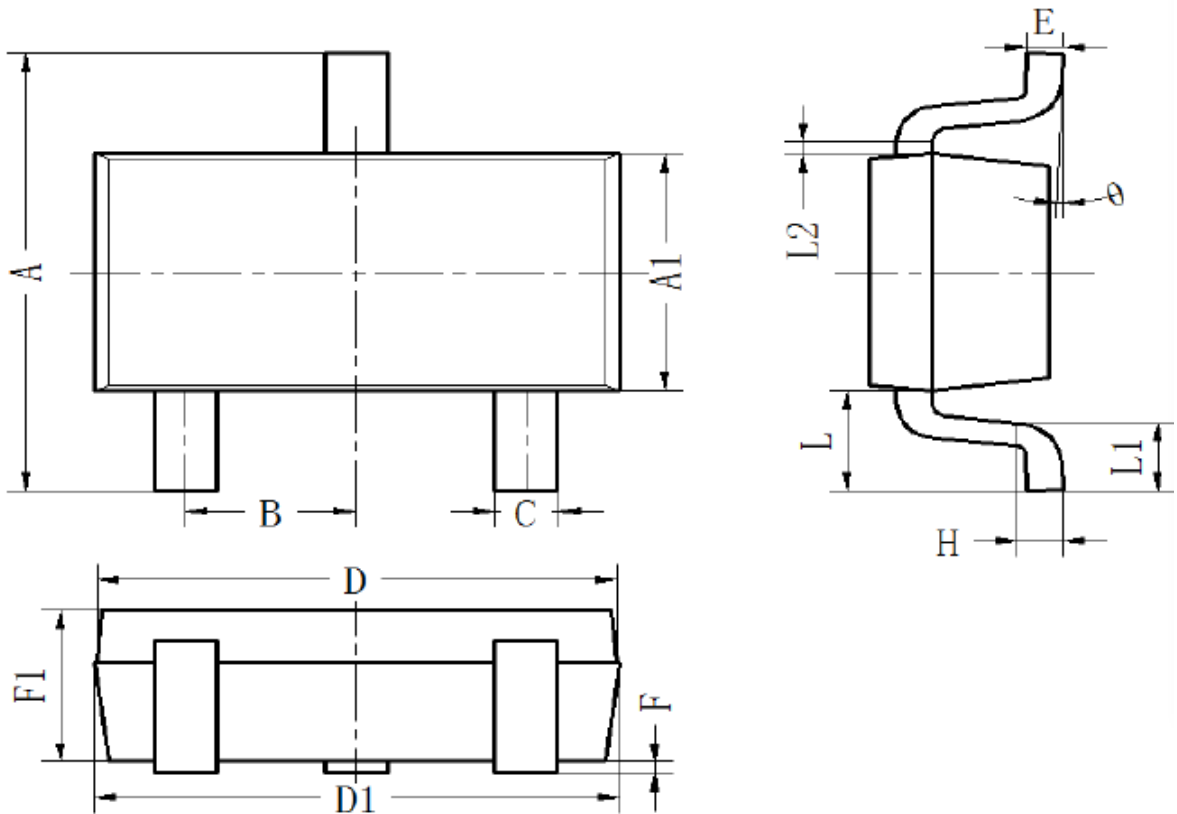
Package Information

SOT 23-3L

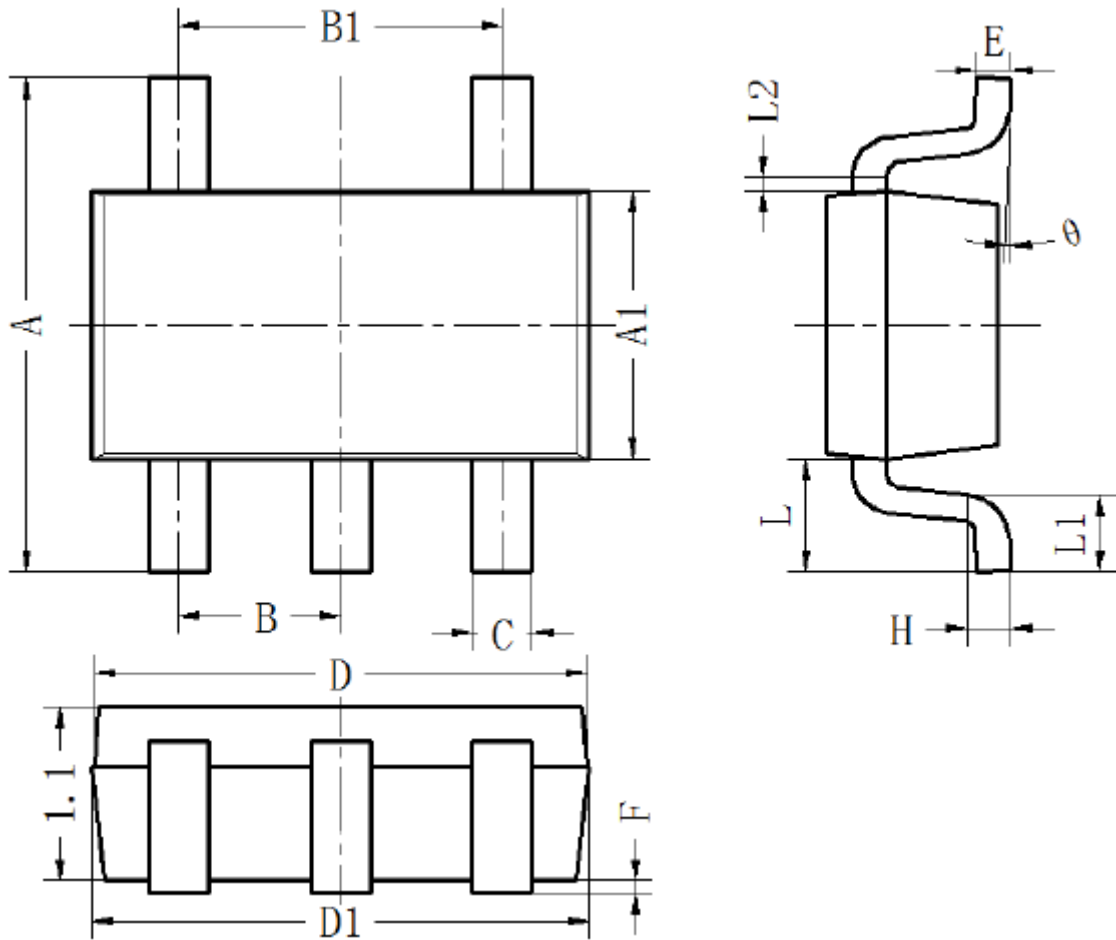
SYMBOL	DIMENSIONS IN MILLIMETERS		
	MIN	NOM	MAX
A	2.65	2.8	2.95
A1	1.5	1.6	1.7
B	0.90	0.95	1.00
C	0.3	0.4	0.5
D	2.82	2.92	3.02
D1	2.87	2.92	2.97
E	0.1	0.15	0.2
H	0.204	0.254	0.304
L	0.55	0.65	0.75
L1	0.3	0.45	0.6
L2	0.06	0.08	0.10
F1	1.05	1.1	1.15
F	0.02	0.08	0.15

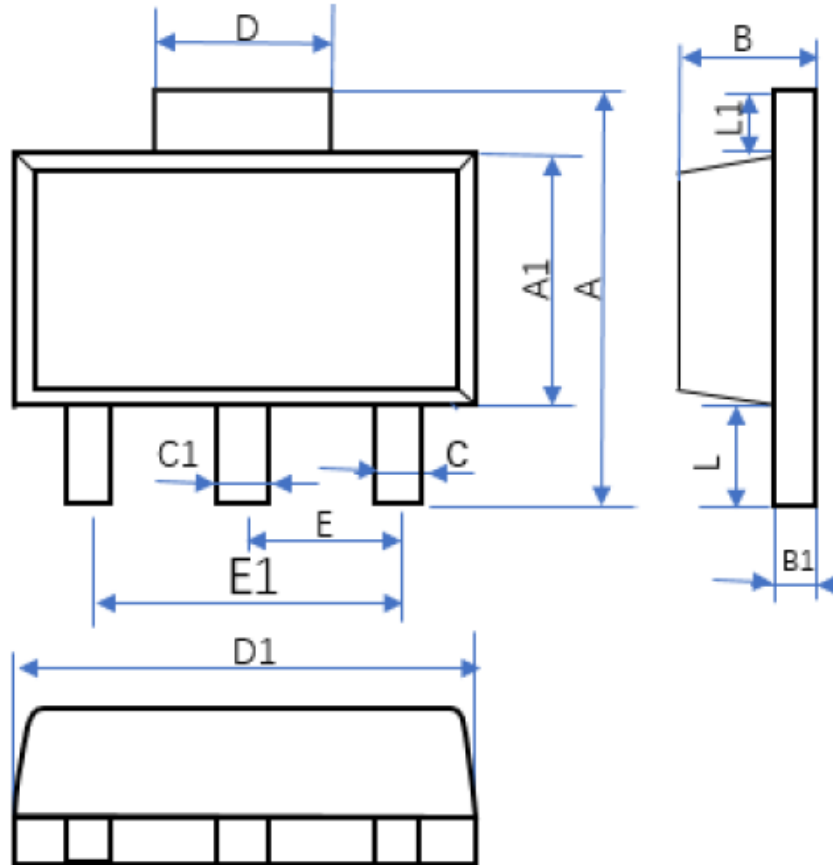

SOT 23-5

SYMBOL	DIMENSIONS IN MILLIMETERS		
	MIN	NOM	MAX
A	2.8	2.9	3.0
A1	1.52	1.57	1.62
B	0.90	0.95	1.0
B1	1.8	1.9	2.0
C	0.35	0.4	0.45
D	2.84	2.89	2.94
D1	2.87	2.92	2.97
E	0.1	0.15	0.2
F	0.02	0.08	0.15
H	0.254	0.254	0.254
L	0.55	0.65	0.75
L1	0.35	0.45	0.55
L2	0.08	0.08	0.08



SOT89-3/L

SYMBOL	DIMENSIONS IN MILLIMETERS		
	MIN	NOM	MAX
A	3.95	4.10	4.25
A1	2.45	2.50	2.55
B	1.44	1.49	1.54
B1	0.35	0.40	0.45
C	0.35	0.40	0.45
C1	0.45	0.50	0.55
D	1.65	1.70	1.75
D1	4.45	4.50	4.55
E	1.45	1.50	1.55
E1	2.95	3.00	3.05
L	0.95	1.02	1.09
L1	0.55	0.60	0.65

Ordering Information

Part Number	Output Voltage	Package	Packing Quantity	Marking*
WR0514-12A21R	1.2V	SOT89-3L	1K/Reel	WR0514 12 XXXX
WR0514-15A21R	1.5V	SOT89-3L	1K/Reel	WR0514 15 XXXX
WR0514-18A21R	1.8V	SOT89-3L	1K/Reel	WR0514 18 XXXX
WR0514-20A21R	2.0V	SOT89-3L	1K/Reel	WR0514 20 XXXX
WR0514-22A21R	2.2V	SOT89-3L	1K/Reel	WR0514 22 XXXX
WR0514-25A21R	2.5V	SOT89-3L	1K/Reel	WR0514 25 XXXX
WR0514-28A21R	2.8V	SOT89-3L	1K/Reel	WR0514 28 XXXX
WR0514-30A21R	3.0V	SOT89-3L	1K/Reel	WR0514 30 XXXX
WR0514-33A21R	3.3V	SOT89-3L	1k/Reel	WR0514 33 XXXX
WR0514-36A21R	3.6V	SOT89-3L	1K/Reel	WR0514 36 XXXX
WR0514-45A21R	4.5V	SOT89-3L	1K/Reel	WR0514 45 XXXX
WR0514-50A21R	5.0V	SOT89-3L	1K/Reel	WR0514 50 XXXX
WR0514-12A20R	1.2V	SOT89-3	1K/Reel	WR0514 12 XXXX
WR0514-15A20R	1.5V	SOT89-3	1K/Reel	WR0514 15 XXXX
WR0514-18A20R	1.8V	SOT89-3	1K/Reel	WR0514 18 XXXX
WR0514-20A20R	2.0V	SOT89-3	1K/Reel	WR0514 20 XXXX
WR0514-22A20R	2.2V	SOT89-3	1K/Reel	WR0514 22 XXXX
WR0514-25A20R	2.5V	SOT89-3	1K/Reel	WR0514 25 XXXX
WR0514-28A20R	2.8V	SOT89-3	1K/Reel	WR0514 28 XXXX
WR0514-30A20R	3.0V	SOT89-3	1K/Reel	WR0514 30 XXXX
WR0514-33A20R	3.3V	SOT89-3	1k/Reel	WR0514 33 XXXX
WR0514-36A20R	3.6V	SOT89-3	1K/Reel	WR0514 36 XXXX
WR0514-45A20R	4.5V	SOT89-3	1K/Reel	WR0514 45 XXXX
WR0514-50A20R	5.0V	SOT89-3	1K/Reel	WR0514 50 XXXX
WR0514-12A30R	1.2V	SOT23-3	3K/Reel	WR0514 12 XXXX
WR0514-15A30R	1.5V	SOT23-3	3k/Reel	WR0514 15 XXXX
WR0514-18A30R	1.8V	SOT23-3	3k/Reel	WR0514 18 XXXX
WR0514-20A30R	2.0V	SOT23-3	3k/Reel	WR0514 20 XXXX
WR0514-22A30R	2.2V	SOT23-3	3k/Reel	WR0514 22 XXXX
WR0514-25A30R	2.5V	SOT23-3	3K/Reel	WR0514 25 XXXX
WR0514-28A30R	2.8V	SOT23-3	3k/Reel	WR0514 28 XXXX
WR0514-30A30R	3.0V	SOT23-3	3k/Reel	WR0514 30 XXXX
WR0514-33A30R	3.3V	SOT23-3	3k/Reel	WR0514 33 XXXX
WR0514-36A30R	3.6V	SOT23-3	3k/Reel	WR0514 36 XXXX
WR0514-45A30R	4.5V	SOT23-3	3k/Reel	WR0514 45 XXXX
WR0514-50A30R	5.0V	SOT23-3	3k/Reel	WR0514 50 XXXX
WR0514-12A50R	1.2V	SOT23-5	3K/Reel	WR0514 12 XXXX

Part Number	Output Voltage	Package	Packing Quantity	Marking*
WR0514-15A50R	1.5V	SOT23-5	3k/Reel	WR0514 15 XXXX
WR0514-18A50R	1.8V	SOT23-5	3k/Reel	WR0514 18 XXXX
WR0514-20A50R	2.0V	SOT23-5	3k/Reel	WR0514 20 XXXX
WR0514-22A50R	2.2V	SOT23-5	3k/Reel	WR0514 22 XXXX
WR0514-25A50R	2.5V	SOT23-5	3k/Reel	WR0514 25 XXXX
WR0514-28A50R	2.8V	SOT23-5	3K/Reel	WR0514 28 XXXX
WR0514-30A50R	3.0V	SOT23-5	3k/Reel	WR0514 30 XXXX
WR0514-33A50R	3.3V	SOT23-5	3k/Reel	WR0514 33 XXXX
WR0514-36A50R	3.6V	SOT23-5	3k/Reel	WR0514 36 XXXX
WR0514-45A50R	4.5V	SOT23-5	3k/Reel	WR0514 45 XXXX
WR0514-50A50R	5.0V	SOT23-5	3k/Reel	WR0514 50 XXXX

Contact Information

No.1001, Shiwan(7) Road, Pudong District, Shanghai, P.R.China.201202

Tel: 86-21-68960674 Fax: 86-21-50757680 Email: market@way-on.com

WAYON website: <http://www.way-on.com>

For additional information, please contact your local Sales Representative.

® is registered trademark of Wayon Corporation.

Specifications are subject to change without notice.

The device characteristics and parameters in this data sheet can and do vary in different applications and actual device performance may vary over time

Users should verify actual device performance in their specific applications.

单击下面可查看定价，库存，交付和生命周期等信息

[>>WAY-ON\(维安\)](#)