

# PC55U14 V0

## Product Specification

## Approval Sheet

PC55U14 V0

Product Specification

RoHS

<b>Product</b>	White SMD LED
<b>Part Number</b>	PC55U14 V0
<b>Issue Date</b>	2016/06/23



### ■ Feature

- ✓ White SMD LED (L x W x H) of 5.8 x 5.2 x 0.7 mm
- ✓ ANSI binning
- ✓ Dice Technology : InGaN
- ✓ Qualified according to JEDEC moisture sensitivity Level 3
- ✓ Environmental friendly ; RoHS compliance
- ✓ Packing : 500 pcs/reel

### ■ Applications

- ✓ MR16, GU10
- ✓ General lighting
- ✓ Outdoor lighting

## Outline Dimension

PC55U14 V0

Product Specification

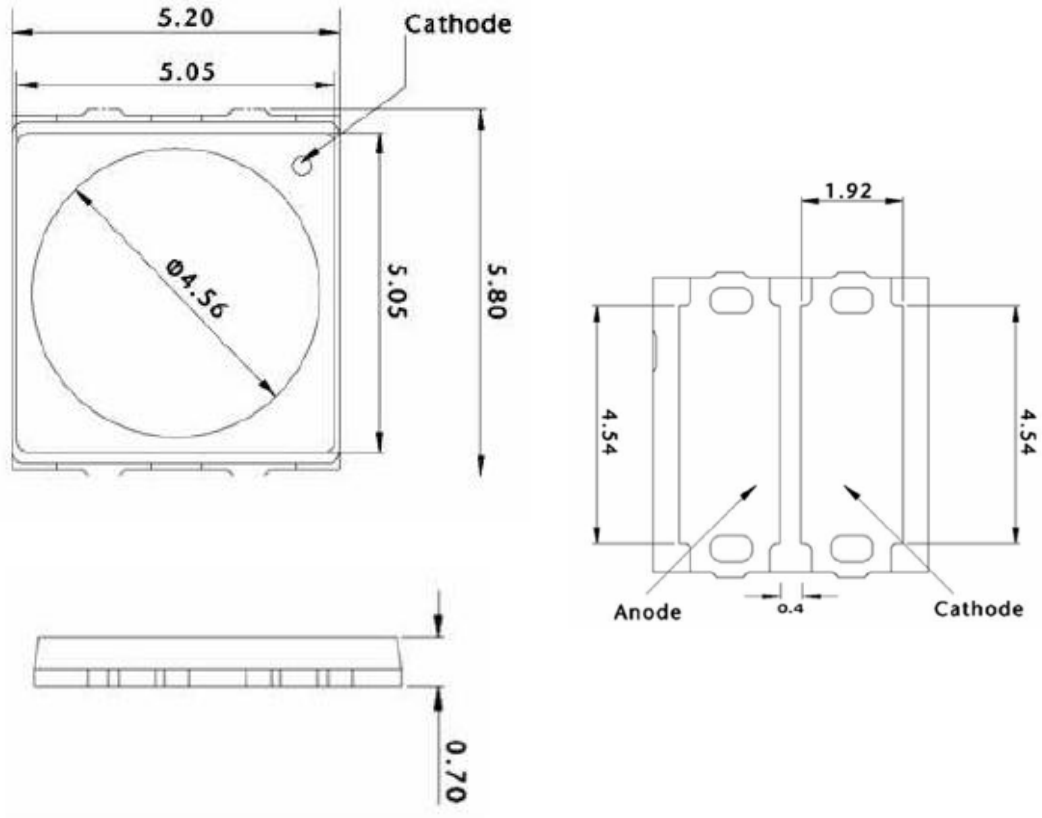

Unit: mm,

Tolerance:  $\pm 0.1$ mm

### ■ Recommended Soldering Pad

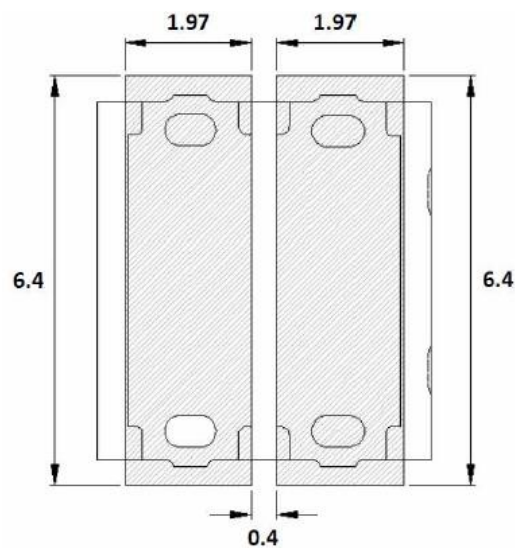

## Performance

PC55U14 V0

Product Specification

### ■ Electro-Optical Characteristics (Ta=25°C)

Parameter	Symbol	Condition	Min.	Typ.	Max.	Unit
Forward Voltage <sup>(1)</sup>	V <sub>F</sub>	I <sub>F</sub> = 150 mA	32.6	36.2	39.8	V
Color Rendering Index <sup>(2)</sup>	R <sub>a</sub>		90	-	-	-
Color Rendering Index <sup>(3)</sup>	R <sub>9</sub>		50			
View Angle	θ		-	120	-	deg
Thermal Resistance <sup>(4)</sup>	R <sub>th</sub>		-	4	-	°C/W

(1) The Forward Voltage tolerance is ±0.1V

(2) The Color Rendering Index is measured at Ta=85°C and tolerance is ±2

(3) The R<sub>9</sub> is measured at Ta=85°C and tolerance is ±6.

(4) Thermal resistance is calculated from junction to solder

### ■ Luminous Flux (Ta=25°C)

CCT	Condition	Rank	Typ.	Unit
2600K~3700K	I <sub>F</sub> = 150 mA	GP,GQ	600	lm
3700K~4200K		GQ,GR	635	

\* The luminous flux tolerance is ± 7%

### ■ Absolute Maximum Ratings

Parameter	Symbol	value	Unit
DC Forward Current <sup>(1)</sup>	I <sub>F</sub>	240	mA
Power Dissipation	P <sub>D</sub>	8.7	W
Pulse Forward Current <sup>(2)</sup>	I <sub>FP</sub>	360	mA
Storage Temperature	T <sub>stg</sub>	-40 ~ 100	°C
Operating Temperature	T <sub>opr</sub>	-40 ~ 100	°C
Junction Temperature	T <sub>J</sub>	125	°C
Assembly Temperature	-	260 (max. 10sec)	°C

(1) Proper current rating must be observed to maintain junction temperature below maximum at all time

(2) IFP Condition: Duty 1/10, Pulse within 10msec

## Ordering Code

**P C 5 5 U 1 4 0 - A 2 7 1 3 0 G P G R Y Y - 0 0 0**

1	2	3	4	5	6	7	8	9	10	11	12	13	14	15	16	17	18	19	20	21	22	23
---	---	---	---	---	---	---	---	---	----	----	----	----	----	----	----	----	----	----	----	----	----	----

Item	Pos.	Code	Spec	
Model Name	1-8	PC55U140	PC55U14 V0	
CIE Center Point	9	A	ANSI 1931 on B.B.L	
CCT	10,11	27	27 = 2700K	
		30	30 = 3000K	
		40	40 = 4000K	
		50	50 = 5000K	
R9	12	1	R9 > 50	
CIE Bin Group <sup>(1)</sup>	13,14	30	273	
		50	273,275	
IV Bin Group	15,16,	GP,GQ	Bin code : GP,GQ	
	17,18	GQ,GR	Bin code : GQ,GR	
Vf Bin Group	19,20	YY	Bin code : Y	
Kitting	CIE <sup>(1)</sup>	21	0	No requirements.
Rules	IV	22	0	No requirements.
	Vf	23	0	No requirements.

(1) The first two digits 27 means CCT in 2700K, can be replaced to 30, 40, 50 for different CCT requirements.

■ **Standard Ordering Code:**

CCT	Ordering Code <sup>(1)</sup>	CIE Bin Group	IV Bin Group	Vf Bin Group
2700K	PC55U140-A27130GPGRYY-000	30	GP,GQ,GR	YY
	PC55U140-A27150GPGRYY-000	50		
3000K	PC55U140-A30130GPGRYY-000	30	GP,GQ,GR	YY
	PC55U140-A30150GPGRYY-000	50		
4000K	PC55U140-A40130GPGRYY-000	30	GP,GQ,GR	YY
	PC55U140-A40150GPGRYY-000	50		
5000K	PC55U140-A50130GPGRYY-000	30	GP,GQ,GR	YY
	PC55U140-A50150GPGRYY-000	50		

(1) Only under an agreement between customer and Lextar Electronics, Ordering codes not in “Standard Ordering Code Definitions” can be supplied.

# Binning

PC55U14 V0  
 Product Specification

## Chromaticity Coordinates(Ta=85°C)

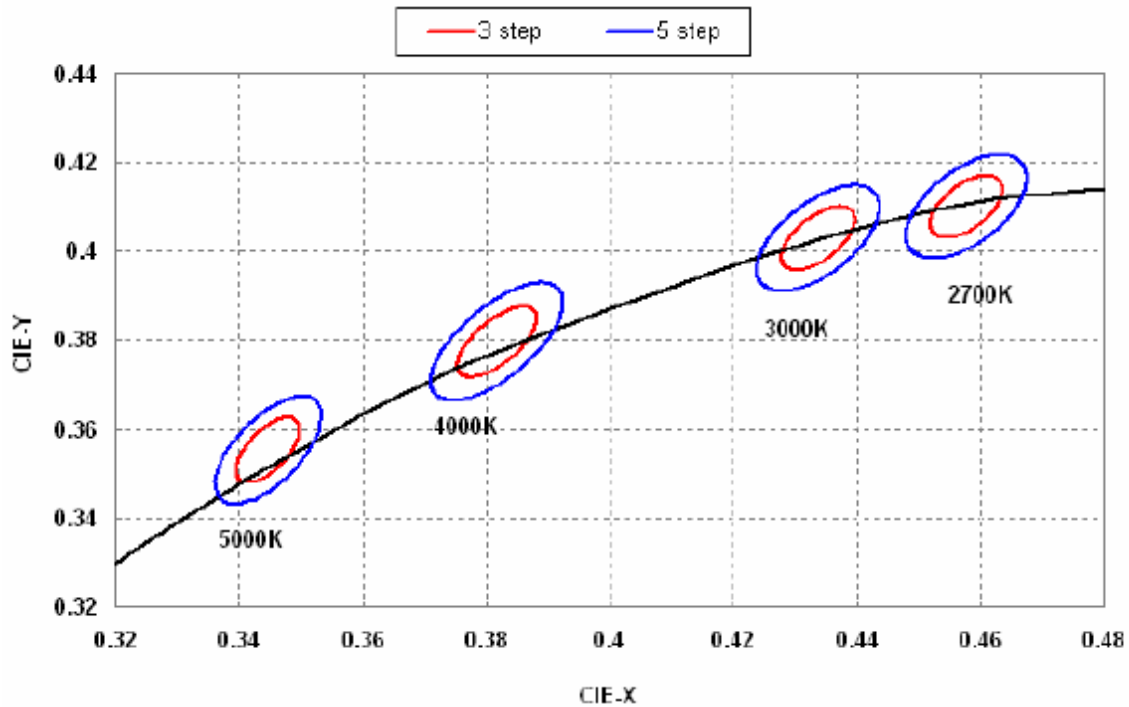

Items	2700K 3-Step (273S)	3000K 3-Step (303S)	4000K 3-Step (403S)	5000K 3-Step (503S)
Center Point, Cx	0.4578	0.4338	0.3818	0.3447
Center Point, Cy	0.4101	0.4030	0.3797	0.3553
Major Axis, a	0.0081	0.0083	0.0093	0.0082
Minor Axis, b	0.0042	0.0040	0.0040	0.0035
Rotation Angle	53.7	53.2	53.7	59.6

Items	2700K 5-Step (275S)	3000K 5-Step (305S)	4000K 5-Step (405S)	5000K 5-Step (505S)
Center Point, Cx	0.4578	0.4338	0.3818	0.3447
Center Point, Cy	0.4101	0.4030	0.3797	0.3553
Major Axis, a	0.0135	0.01390	0.0156	0.0137
Minor Axis, b	0.0070	0.00680	0.0040	0.0059
Rotation Angle	53.7	53.2	53.7	59.6

■ **Bin code definition**

CIE Rank	Luminous Flux Rank	V <sub>F</sub> Rank
273S	GP	Y

V <sub>F</sub> Rank	Condition	Min.	Max.
Y	I <sub>F</sub> = 150 mA	32.6	39.8

Luminous Flux Rank	Condition	Min.	Max.
GP	I <sub>F</sub> = 150 mA	550	600
GQ		600	660
GR		660	726
GS		726	799

Note:

- (1) Correlated color Temperature is derived from the CIE 1931 Chromaticity diagram
- (2) CIE Measurement tolerance is ± 0.005
- (3) The luminous flux tolerance is ±7%
- (4) The Forward Voltage tolerance is ±3%



## Characteristics

PC55U14 V0  
Product Specification

### Radiation Pattern

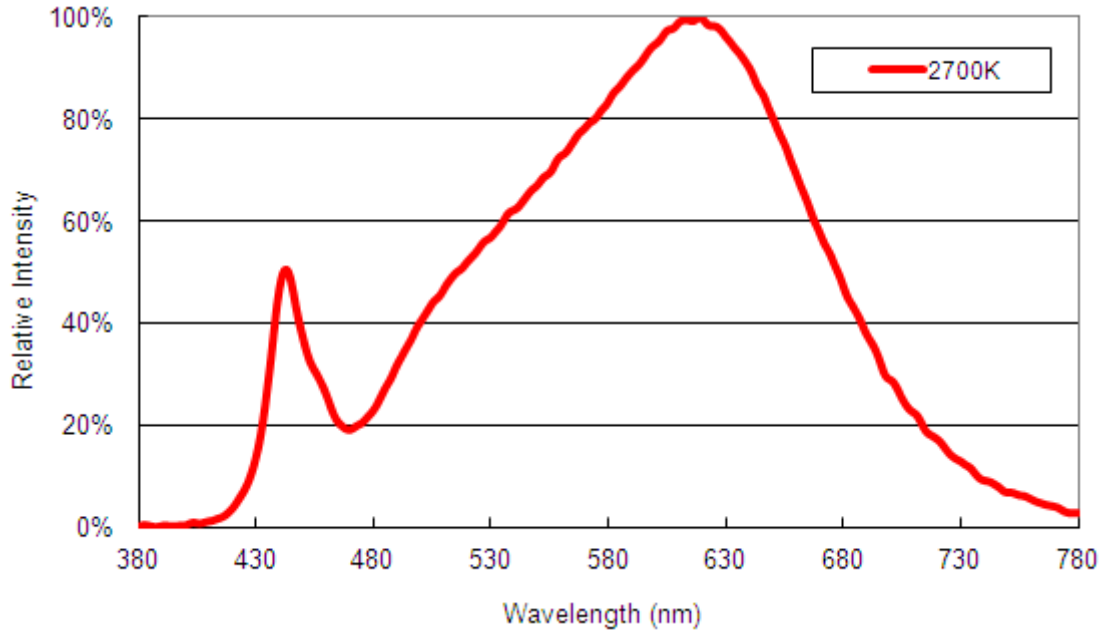

### Radiation Pattern

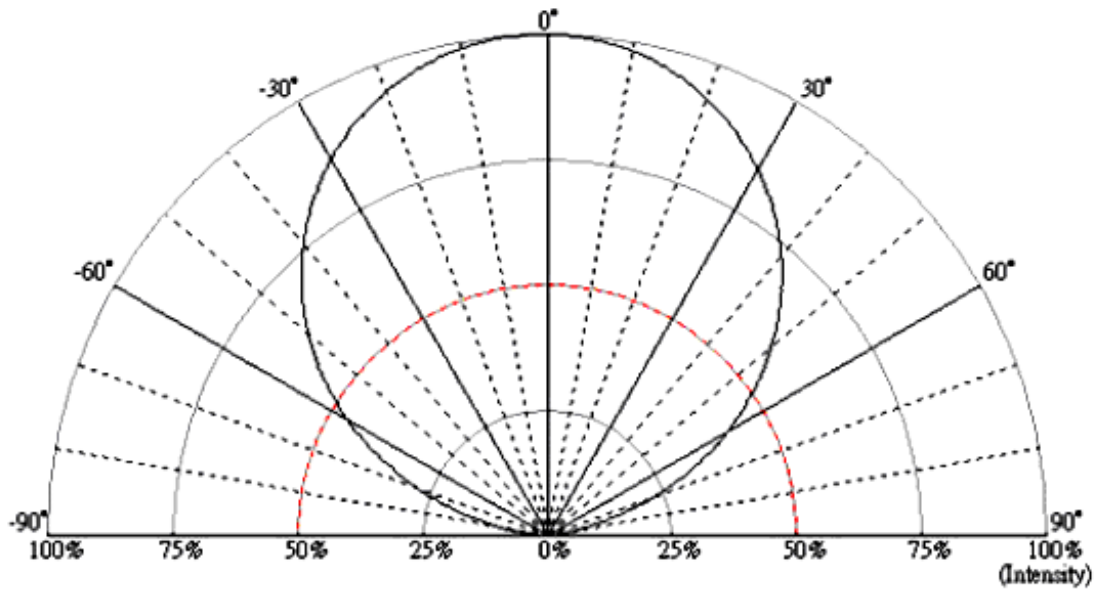

■ **Forward Voltage vs. Forward Current**

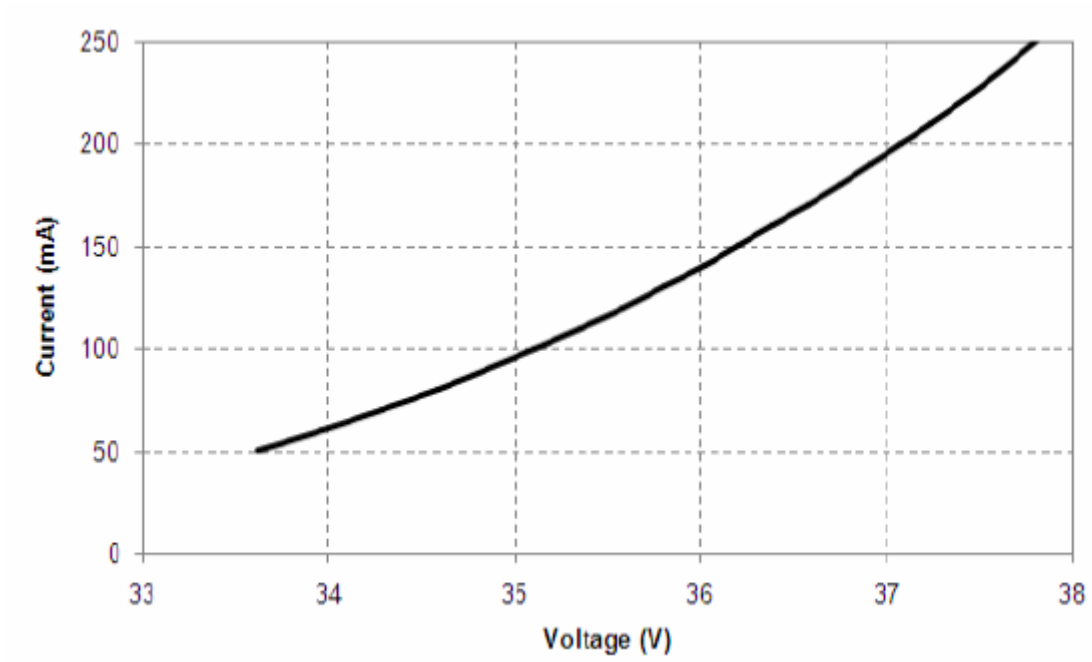

■ **Forward Current vs. Relative Luminosity**

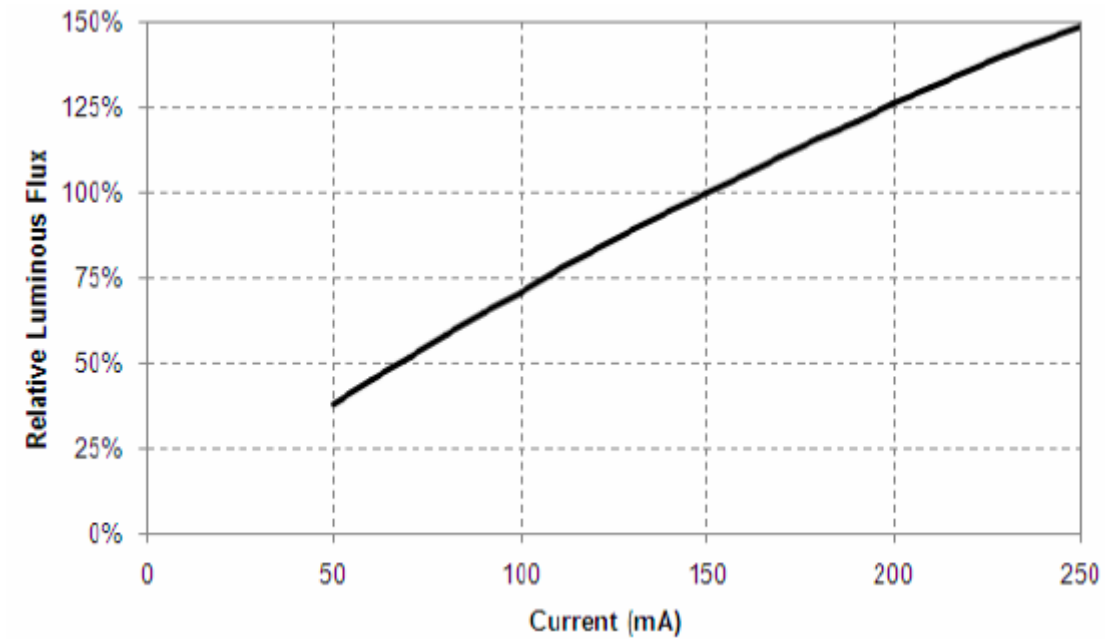

■ **Relative Luminous Intensity vs. Ambient Temperature**

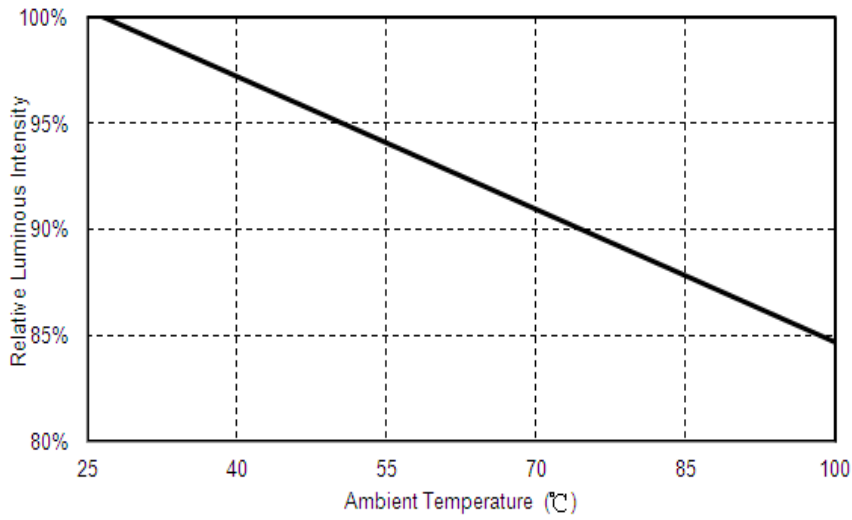

■ **Chromaticity vs. Ambient Temperature**

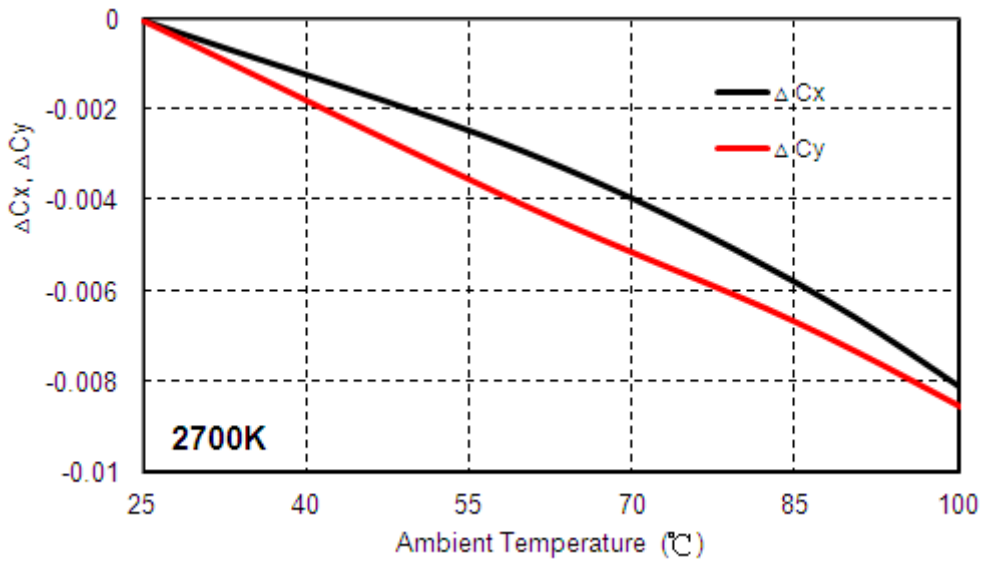

■ **Relative VF vs. Ambient Temperature**

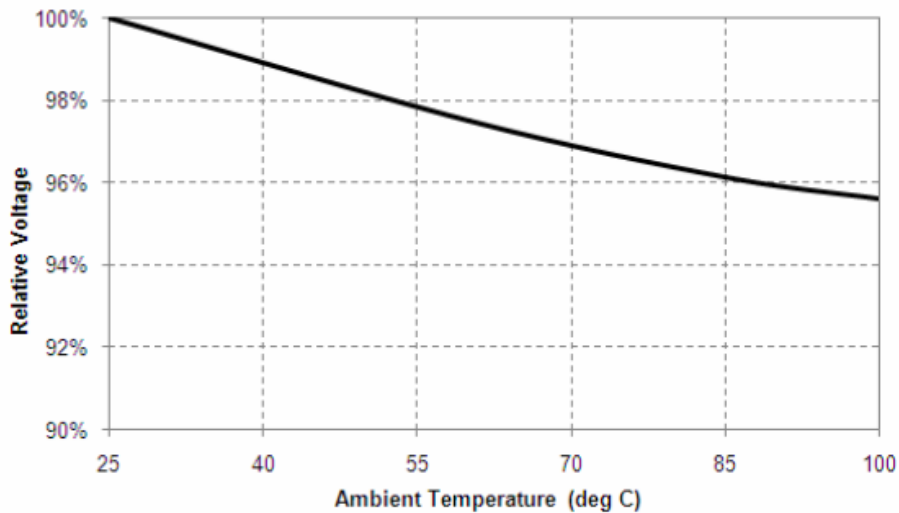

**Reliability**

PC55U14 V0

Product Specification

**Reliability test**

Item	Condition	Time/Cycle
Steady State Operating Life of Low Temperature -40°C	-40°C Operating	1000 Hrs
Steady State Operating Life of High Temperature 60°C	60°C Operating	1000 Hrs
Steady State Operating Life of High Temperature 85°C	85°C Operating	1000 Hrs
Steady State Operating Life of High Temperature 100°C	105°C Operating	1000 Hrs
Low temperature storage -40°C	-40°C Storage	1000 Hrs
High temperature storage 100°C	105°C Storage	1000 Hrs
Steady State Operating Life of High Humidity Heat 60°C 90%	60°C/90% Operating	1000 Hrs
Resistance to soldering heat on PCB (JEDEC MSL3)	pre-store@60°C, 60%RH for 52hrs Tsltd max.=260°C 10sec	3 Times
Thermal shock	-40°C/20minr ~5minr ~ 100°C/20min	300 Cycles

**Judgment Criteria**

Item	Symbol	Test Condition	Judgment Criteria
Forward Voltage	Vf	150mA	$\Delta Vf < 10 \%$
Luminous Flux	Iv	150mA	$\Delta Iv < 30 \%$

## Packing

PC55U14V0  
Product Specification

### Label

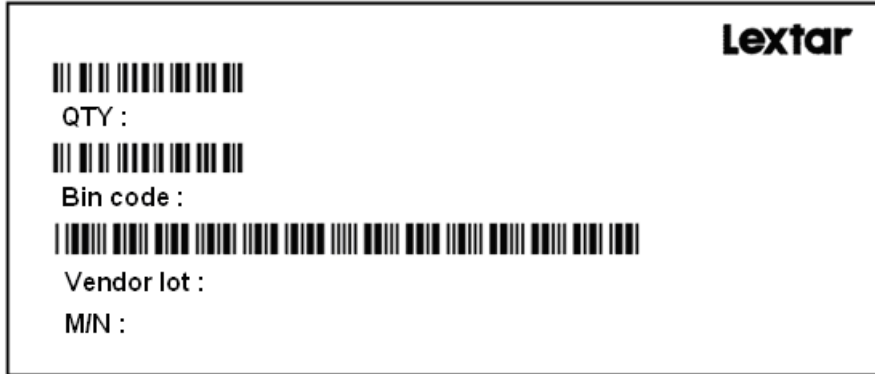

### Carrier Taping

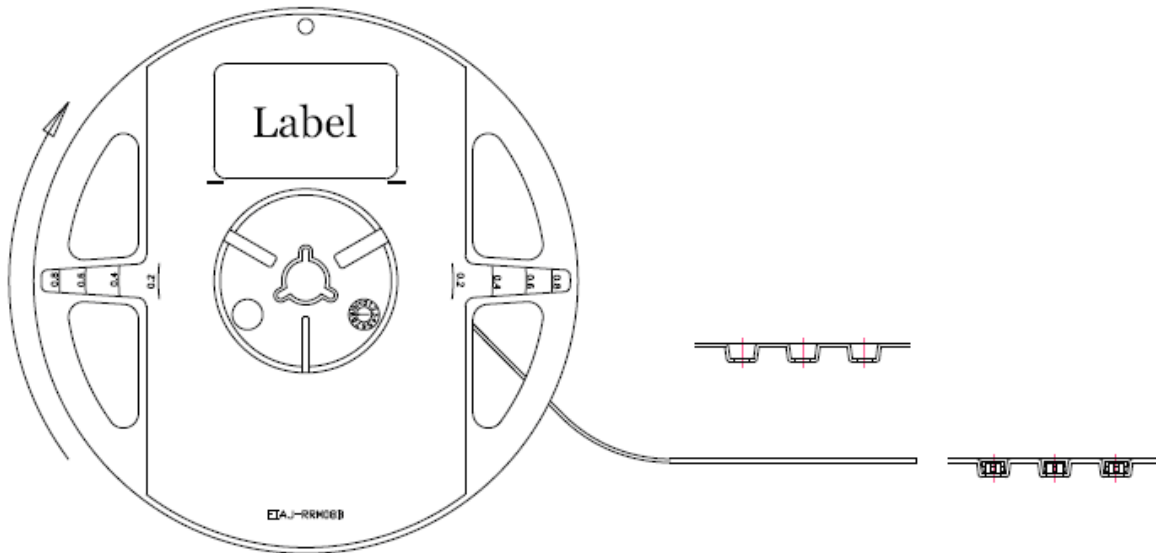

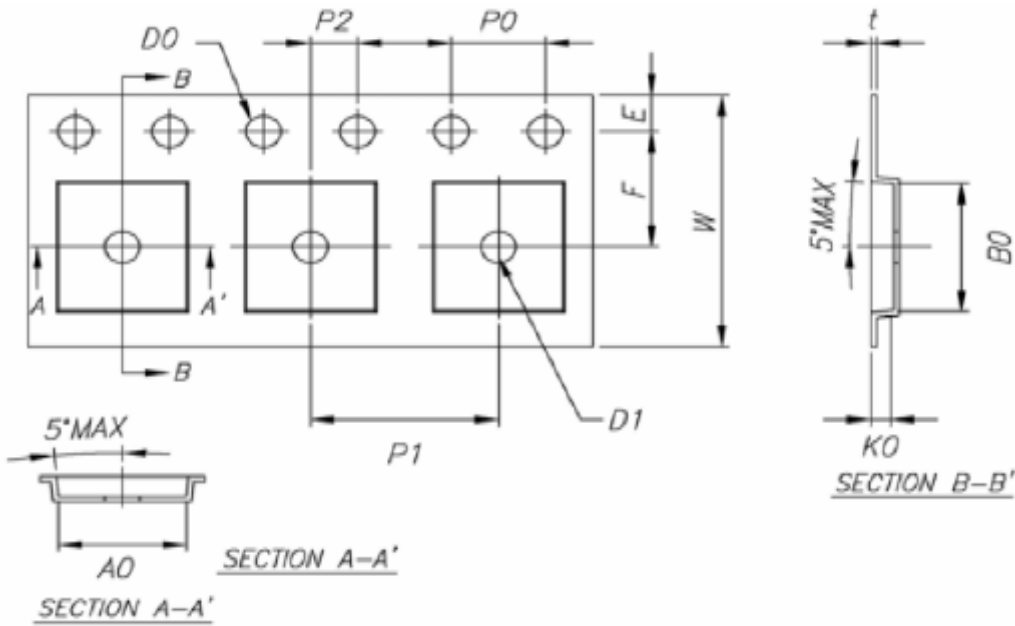

PS : unit : mm

Notice:

1. 10 Sprocket hole pitch cumulative tolerance is  $\pm 0.20\text{mm}$ .
2. Carrier camber shall be not more than 1mm per 100mm through a length of 250mm.
3.  $A_0$  &  $B_0$  measured on a place in the middle of the corner radii.
4.  $K_0$  measured from a place on the inside bottom of the pocket to top surface of carrier.
5. Pocket position relative to sprocket hole measured as true position of pocket, not pocket hole.
6. Surface resistivity  $10^4 \sim 10^8 \text{ ohm/sq}$ .

### Shield Bag Taping

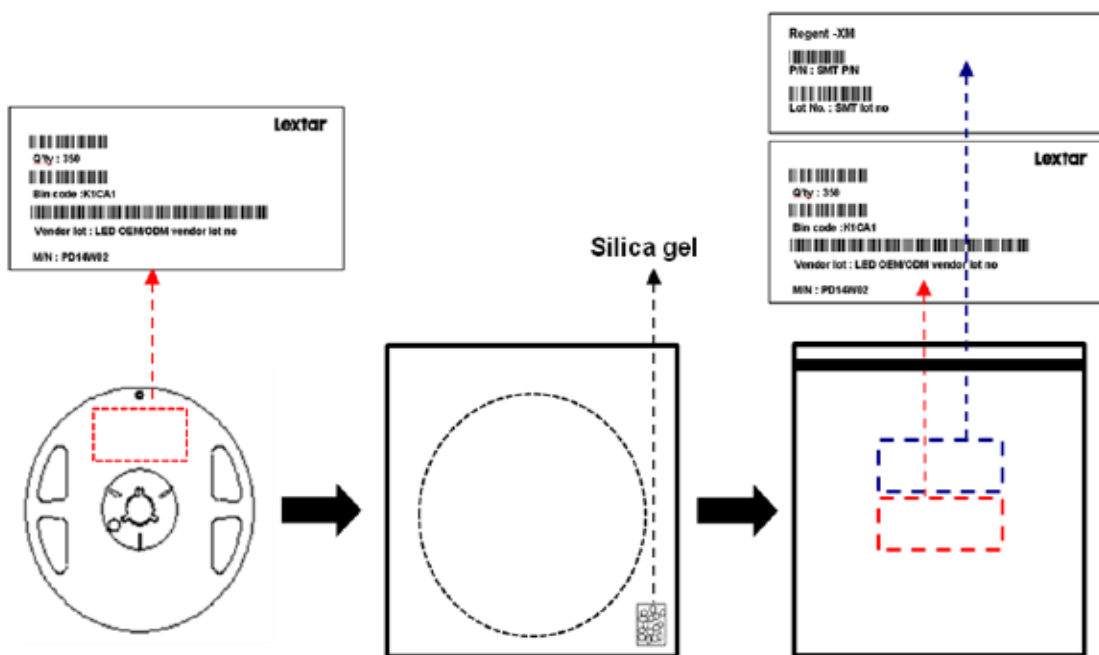

■ **Packing Box**

Type	Large Box		Medium Box		Small Box	
Dimension	541X511X276mm		385X303X260mm		283X235x70mm	
Maximum Reels	7"X12mm Reel	64/R	7"X12mm Reel	21/R	7"X12mm Reel	4/R
Minimum Reels	7"X12mm Reel	32/R	7"X12mm Reel	9/R	7"X12mm Reel	1/R

■ **Small Box**

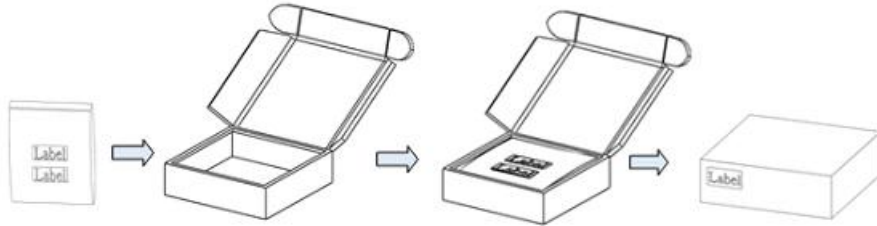

■ **Medium Box**

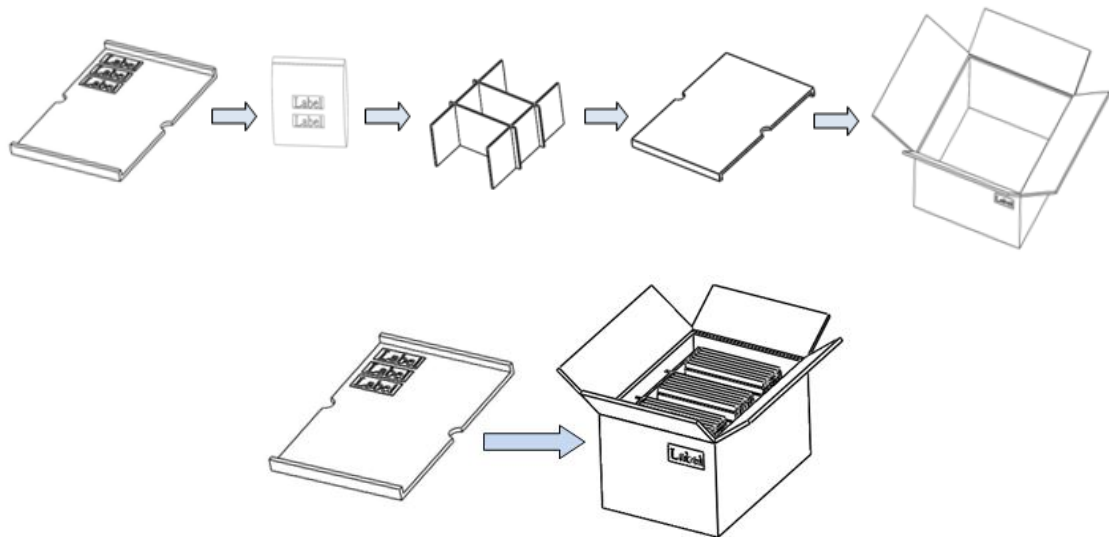

■ **Large Box**

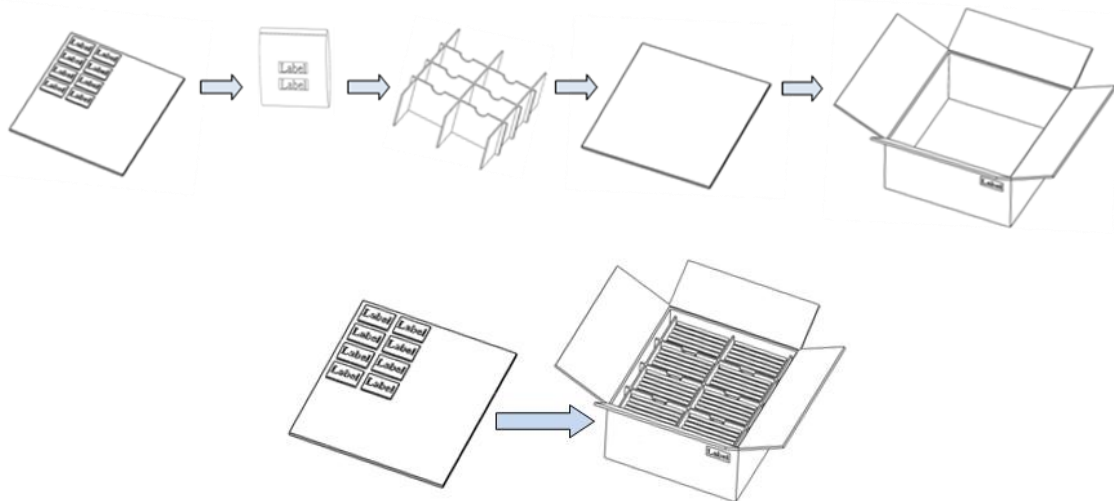

## Precautions

PC55U14 V0

Product Specification

### ■ Safety Precautions

- The LED light output is too strong for human eyes without shield. Prevent eye contact directly more than seconds.
- Ensure operating under maximum rating.

### ■ Storage

- Before opening the package, the LEDs should storage under 30°C, 60% RH.
- After opening the package bag, the LEDs should be keep under 30°C, 60% RH. Recommend to use within 168 hrs. If unused LEDs remain, suggest to store into moisture proof bag or original package bag with moisture absorbent material such as silica gel. Reseal well is necessary.
- If the product exceeded the storage period or the moisture absorbent material faded away, baking treatment should be done by following conditions.  
Bake condition: 60°C, 12hours (One time only).

### ■ Soldering Notice and Conditions

- When soldering LEDs,
- Do not solder/reflow the same LED over two times.
- Recommend soldering conditions:  
Hand soldering: 350 °C max , 3 sec. max.  
Reflow soldering: Pre-heat 150 °C max , 180 sec. max.  
Peak 260 °C max , 10 sec. max.
- Reflow temperature profile as below: (lead-free solder)

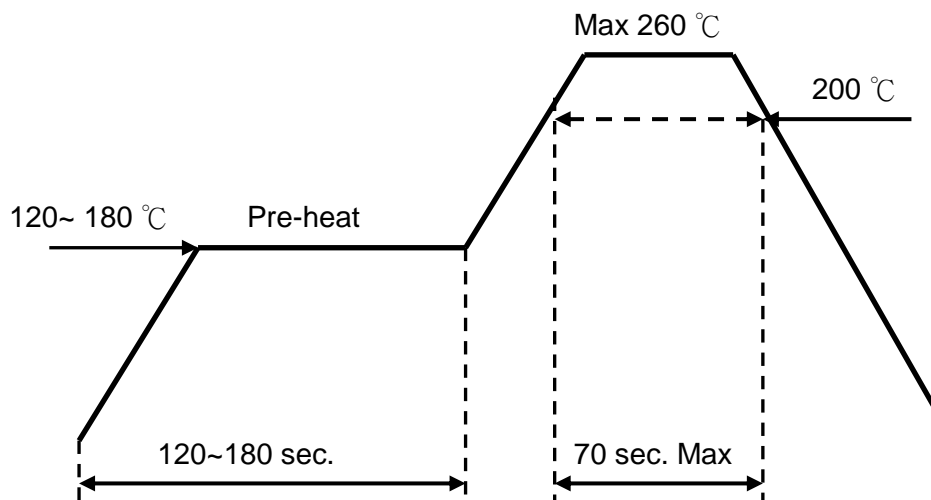



- When soldering, don't put stress on the LEDs
- After LEDs have been soldered, strongly recommend not to repair to keep the LEDs performance.

### ■ Static Electricity

- LED package is extremely sensitive to static electricity. It's recommended that anti-electrostatic glove and wrist band is necessary when handling the LEDs. All devices are also be grounded properly as well.
- Protection devices design should be considered in the LED driving circuit.

### ■ Cleaning

- If washing is required, recommend to use alcohol as a solvent.
- Recommend to avoid cleaning the LEDs by ultrasonic. If necessary, pre-test the LED is necessary to confirm whether any damage occur after the process.

## Revision History

PC55U14 V0  
Product Specification

Date	Contents	Writer	Approved
2016.06.23	New version	Kenis Hung	Berris Huang

## *Smart Lighting Amazing Life*

Lextar Electronics Corp. is the leading LED (Light Emitting Diode) maker integrating upper stream epitaxial, middle stream chip, and downstream package, SMT and LED lighting applications. Founded in May, 2008, Lextar is a subsidiary of AU Optronics, the leading TFT-LCD and solar PV manufacturer. Lextar's product applications include lighting and LCD backlight. Lextar's manufacturing sites include Hsinchu and Chunan in Taiwan, and Suzhou in China. The company turnover in 2010 is 266 million USD.

单击下面可查看定价，库存，交付和生命周期等信息

[>>Lextar\(隆达\)](#)