



Thin Film Chip Fuse



Document No	TCF-XX0S032N
Issued date	2023/07/21
Page	1/19

1. Scope

This specification applies for the fuse series of thin film chip fuse made by TA-I.

2. Construction

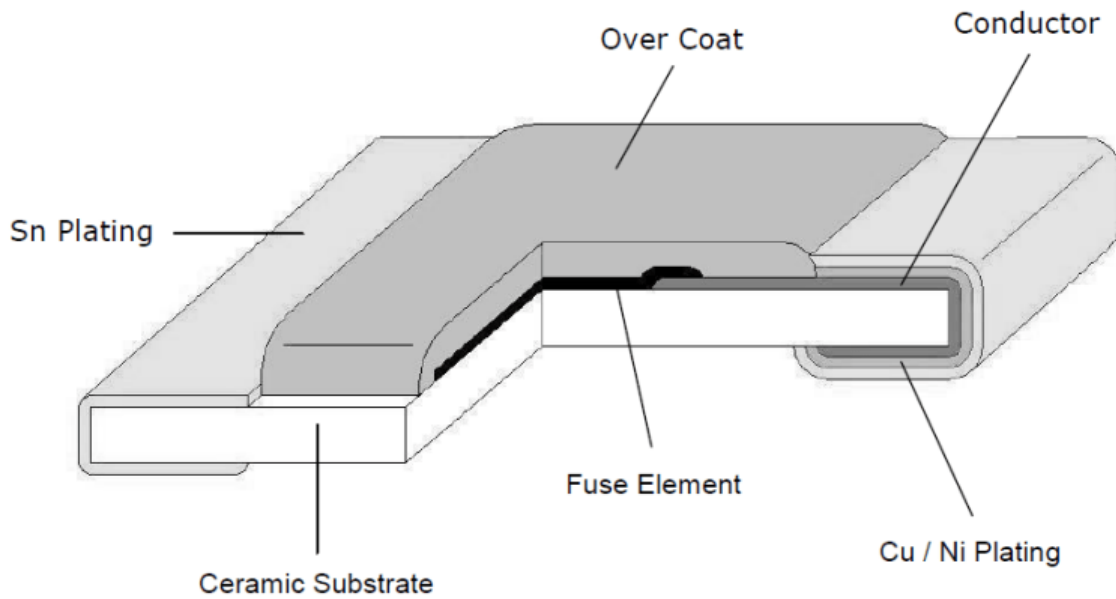

3. Type Designation

CF	06	V5	T	R50
	Size	Rate Voltage	Packaging	Rate Current
Chip Fuse	04:0402(1005) 06:0603(1608) 12:1206(3216)	V6:63V V5:50V V3:32V	T: Paper Tape (5K/10K)	R50:0.5A 1R0:1A



Thin Film Chip Fuse



Document No	TCF-XX0S032N
Issued date	2023/07/21
Page	2/19

4. Dimensions

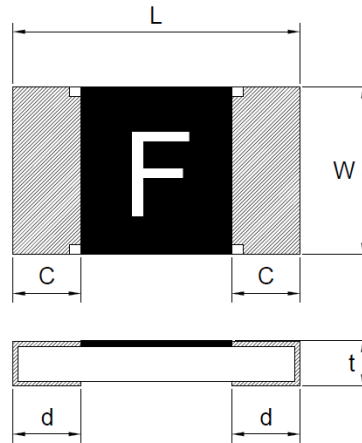

Unit: mm

Type (Inch Size code)	Dimensions (mm)				
	L	W	C	d	t
CF04 (0402)	1.0±0.1	0.52±0.05	0.2±0.1	0.25±0.1	0.35±0.05
CF06 (0603)	1.6±0.1	0.80±0.10	0.3±0.2	0.35±0.2	0.45±0.10
CF12 (1206)	3.1±0.1	1.55±0.10	0.5±0.3	0.50±0.2	0.60±0.10

5. Applications and ratings

Part Designation	Marking	Rated Current	Fusing Time	Resistance (mΩ) Tolerance (±25%)	Rated Voltage	Breaking Capacity	Body Temperature rising
CF04V3TR315	D	0.315A	Open within 1min.at 200% rated current	690	DC 32V	DC32V 35A	<75°C at 100% rated current
CF04V3TR50	F	0.500A		340			
CF04V3TR75	V	0.750A		140			
CF04V3TR80	K	0.800A		100			
CF04V3T1R0	L	1.000A		95			
CF04V3T1R25	M	1.250A		57			
CF04V3T1R50	P	1.500A		45			
CF04V3T1R60	N	1.600A		44			
CF04V3T2R0	S	2.000A		33			
CF04V3T2R50	T	2.500A		25			
CF04V3T3R0	3	3.000A		19			
CF04V3T3R15	U	3.150A		18			
CF04V3T4R0	W	4.000A		12			

*Resistance value was measured with less than 10% of rated current



Thin Film Chip Fuse



Document No	TCF-XX0S032N
Issued date	2023/07/21
Page	3/19

Part Designation	Marking	Rated Current	Fusing Time	Resistance (mΩ) Tolerance (±25%)	Rated Voltage	Breaking Capacity	Body Temperature rising
CF06V5TR40	E	0.40A	Open within 1min. at 200% rated current	496	DC 50V	DC50V 50A	<75°C at 100% rated current
CF06V5TR50	F	0.50A		290			
CF06V3TR63	I	0.63A		205	DC 32V	DC32V 50A	
CF06V3TR80	K	0.80A		132			
CF06V3T1R0	L	1.00A		84			
CF06V3T1R25	<u>M</u>	1.25A		63			
CF06V3T1R50	P	1.50A		50.5			
CF06V3T1R60	N	1.60A		45			
CF06V3T2R0	S	2.00A		34	DC 32V	DC32V 50A	
CF06V3T2R50	T	2.50A		24.5			
CF06V3T3R00	3	3.00A		20			
CF06V3T3R15	U	3.15A		19			
CF06V3T4R0	W	4.00A		13			
CF06V3T5R0	Y	5.00A		11			

*Resistance value was measured with less than 10% of rated current

Part Designation	Marking	Rated Current	Fusing Time	Resistance (mΩ) Tolerance±25%	Rated Voltage	Breaking Capacity	Body Temperature rising
CF12V6TR50	F	0.50A	Open within 1min.at 200% rated current	517	DC 63V	DC63V 50A	<75°C at 100% rated current
CF12V6TR80	K	0.80A		211			
CF12V6T1R0	L	1.00A		132			
CF12V6T1R25	<u>M</u>	1.25A		95			
CF12V6T1R50	P	1.50A		76			
CF12V6T2R0	S	2.00A		40.5			
CF12V3T2R50	T	2.50A		31.5	DC 32V	DC32V 50A	
CF12V3T3R00	3	3.00A		23.25			
CF12V3T4R0	W	4.00A		16			
CF12V3T5R0	Y	5.00A		12			
CF12V3T7R0	Z	7.00A		7.5			

*Resistance value was measured with less than 10% of rated current



Thin Film Chip Fuse



Document No	TCF-XX0S032N
Issued date	2023/07/21
Page	4/19

6 Temperature Derating Curve

6.1 Normal Ambient Temperature: 25°C

6.2 Operating Temperature: -20°C ~105°C , with proper derating factor as below:

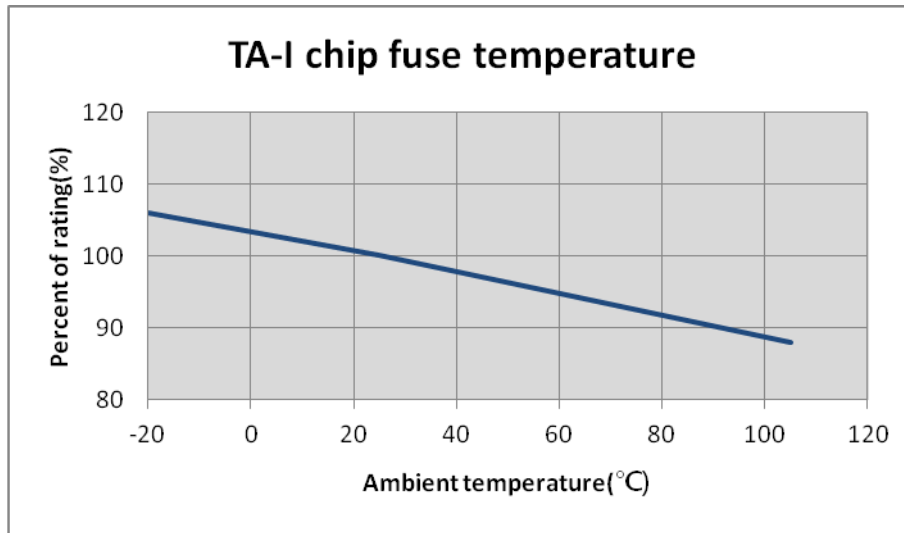

7 Reliability Tests

Parameter	Requirement	Test Method
Carrying capacity	No fusing	Rated current ,4hr
Fusing Time	Within 1 minute	200% of its rated current
Interrupting Ability	No mechanical damages	After the fuse is interrupted, rated voltage applied for 30sec again
Bending Test	No mechanical damages	Distance between holding points: 90mm, Bending:3mm,1time ,30sec
Resistance to solder Heat	±20%	260°C±5°C ,10±1second
Solderability	95% coverage minimum	235°C±5°C , 2±0.5second 245°C±5°C , 2±0.5second (Lead Free)
Temperature Rise	<75°C	100% of its rated current, Measure of surface temperature
Resistance to Dry Heat	±20%	105°C±5°C ,1000 hrs
Resistance to Solvent	No evident damages on protective coating and marking	23°C±5°C of Isopropyl alcohol 90second
Residual Resistance	10kΩ and more	Measure DC resistance after fusing
Thermal Shock	ΔR< 10 %	-20°C/+25°C/+125°C/+25°C , 10 cycles



Thin Film Chip Fuse



Document No	TCF-XX0S032N
Issued date	2023/07/21
Page	5/19

8 Taping & Reel

8.1 Taping Dimensions

4mm pitch paper

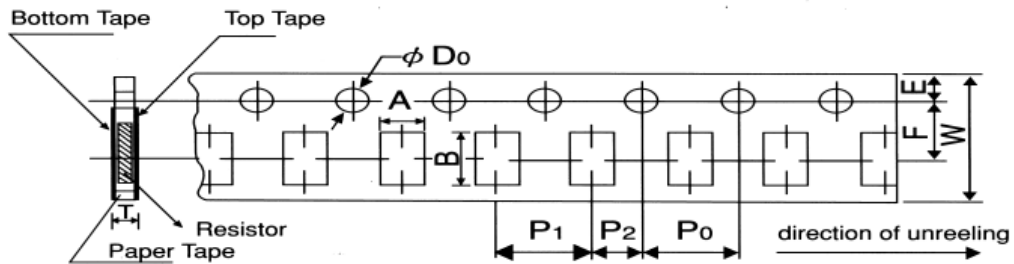

Packing	Type	A	B	W	F	E	P ₁	P ₂	P ₀	D ₀	T
Paper Tape	CF04	0.7±0.05	1.2±0.05	8.0±0.2	3.5±0.05	1.75±0.1	2.0±0.1	2.0±0.05	4.0±0.1	$\phi \begin{matrix} +0.1 \\ 1.5 \\ 0 \end{matrix}$	0.45±0.1
Paper Tape	CF06	1.1±0.1	1.9±0.1	8.0±0.2	3.5±0.05	1.75±0.1	4.0±0.1	2.0±0.05	4.0±0.1	$\phi \begin{matrix} +0.1 \\ 1.5 \\ -0 \end{matrix}$	0.64±0.1
Paper Tape	CF12	2.0±0.15	3.6±0.2	8.0±0.2	3.5±0.05	1.75±0.1	4.0±0.1	2.0±0.05	4.0±0.1	$\phi \begin{matrix} +0.1 \\ 1.5 \\ -0 \end{matrix}$	0.84±0.1

Unit: mm

Type Size		Paper Tape
		2 mm pitch
		180mm/R
CF	04	10000

Type series		Paper Tape
		4 mm pitch
		180mm/R
CF	06	5000
CF	12	5000



Thin Film Chip Fuse



Document No	TCF-XX0S032N
Issued date	2023/07/21
Page	6/19

8.2 Reel Specifications

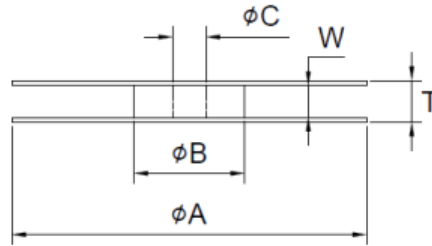

Unit: mm

Series	ϕA	ϕB	ϕC	W	T
CF04 CF06 CF12	178 \pm 2.0	60.0 \pm 1.0	13.0 \pm 1.0	9.0 \pm 1.0	11.4 \pm 2.0

8.3 Peel –off force:

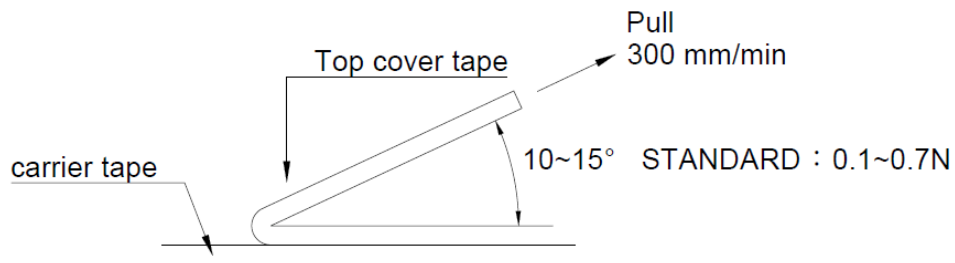

9 Storage Conditions:

Temperature: 5°C~35°C, Humidity:40%~75%

10 Shelf Life:

2 years from manufacturing date



Thin Film Chip Fuse



Document No	TCF-XX0S032N
Issued date	2023/07/21
Page	7/19

11 Label

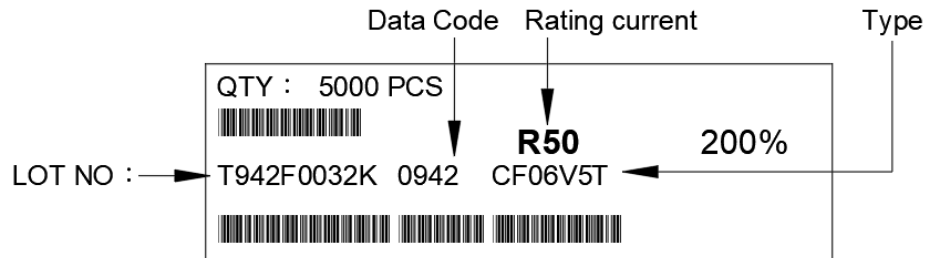

12 Recommended land patterns

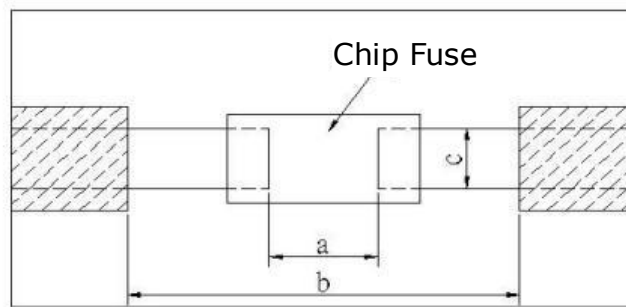

Land pattern		Dimension		
Type	Size	a	b	c
CF	04 (0402)	0.55~0.65	1.40~1.60	0.74~0.94
CF	06 (0603)	0.85~0.95	2.00~2.20	1.50~1.70
CF	12 (1206)	0.95~1.05	4.40~5.00	2.30~2.50



Thin Film Chip Fuse



Document No	TCF-XX0S032N
Issued date	2023/07/21
Page	8/19

13. Recommend IR – Reflow profile: (solder: Sn96.5 / Ag3 / Cu0.5)

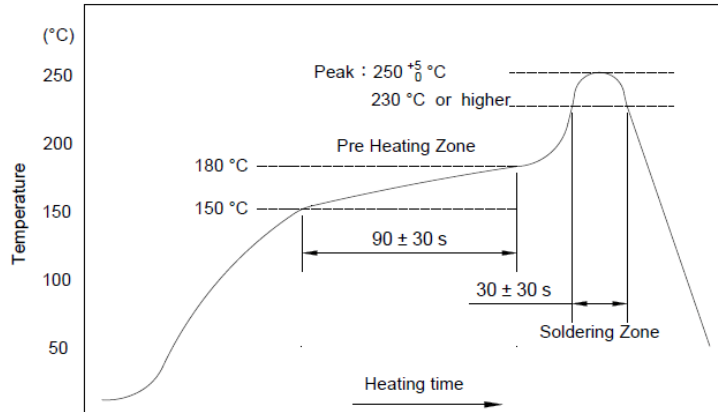

Peak : $250 \pm 5/0$ °C , 5 sec.
Pre-heat Zone : 150 to 180 °C , 90 ± 30 sec
Soldering Zone : 230°C or higher , 30 ± 10 sec

14. Approval by UL248-14

The fuses have been approved by UL.
File No. of UL Recognition is E241710

15. ECN

Engineering Change Notice: The customer will be informed with ECN if there is significant modification on the characteristics and materials described in Approval Sheet.

16. Manufacturing Country & City:

TA-I TECHNOLOGY CO., LTD. (Taiwan– Tao Yuan)

Tel: (+886) 3-3246169 Fax: (+886) 3-3246167

Associated companies:

(1) TA-I TECHNOLOGY (SU ZHOU) CO., LTD. (China – Su Zhou)

Tel: (+86) 512-63457879 Fax: (+86) 512-63457869

(2) TA-I TECHNOLOGY ELECTRONIC (DONGGUAN) CO., LTD. (China –Dongguan)

Tel: (+86) 769-8339-4790~3 Fax: (+86) 769-8339-4794

(3) FORTUNE TASK RESISTOR FACTORY (China – Dongguan)

Tel: (+86) 769-8339-4790~3 Fax: (+86) 769-8339-4794

(4) TAI OHM ELECTRONICS (M) SDN. BHD. (Malaysia – Penang)

Tel: (+60) 4- 3900480 Fax: (+60) 4-3901481



Thin Film Chip Fuse



Document No	TCF-XX0S032N
Issued date	2023/07/21
Page	9/19

17. Selection Guideline of Fuse:

■ Checklist of selection factors

- ⊙ Normal operating current
- ⊙ Normal operating voltage (AC or DC)
- ⊙ Ambient Temperature
- ⊙ Overload current and length of time in which the fuse must open .
- ⊙ Type of fuse (SMD or Tube) and physical size limitation (0603 or 1206)
- ⊙ Agency Approval required (e.g., UL248-14)

■ Normal operating current

e.g., Rectangular Wave, If $I_p = 1.5 \text{ A}$, Normal operating current = 1.5 A

No.	Type	Waveform	Formula
1	Sinusoidal Waveform		$\frac{1}{\sqrt{2}} I_m \cong 0.707 I_m$
2	All Wave Rectification		$\frac{1}{\sqrt{2}} I_m \cong 0.707 I_m$
3	Half Wave		$0.5 I_m$
4	Triangle Waveform		$\frac{1}{3} I_m \cong 0.577 I_m$
5	Rectangular Waveform		I_m
6	Trapezoidal Waveform		$I_m \sqrt{1 - \frac{8\alpha}{3T}}$



Thin Film Chip Fuse



Document No	TCF-XX0S032N
Issued date	2023/07/21
Page	10/19

No.	Type	Waveform	Formula
7	Rectangular Pulse		$I_m \sqrt{\frac{\tau}{T}}$
8	Triangle Pulse		$I_m \sqrt{\frac{\tau}{3T}}$

■ Derating ratio for different ambient Temperature

- ⊙ Referring to bottom figure and select the appropriate derating ratio :
e.g., Ambient temperature is 60 degree C
the derating ratio \approx 0.95

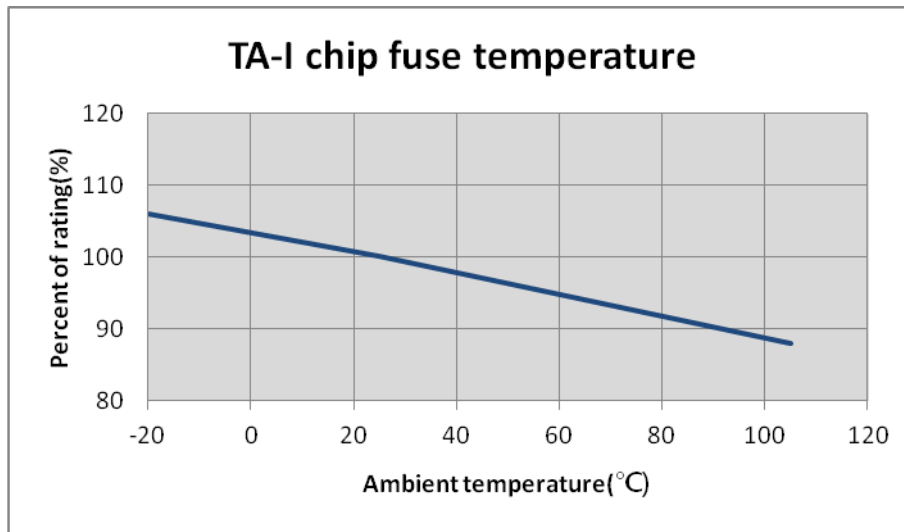

■ Calculating the required rating of fuse needed.

- ⊙ Safety coefficient: 70% is safety coefficient from practical experience

- ⊙
$$\frac{\text{Normal Operating Current}}{0.7 \times \text{derating ratio}} < \text{rating current of fuse}$$

- ⊙ e.g.

Condition: Normal operating current = 1.5 A

Ambient temperature 40 °C : Derating ratio \approx 0.95



Thin Film Chip Fuse



Document No	TCF-XX0S032N
Issued date	2023/07/21
Page	11/19

$$\frac{1.5}{0.7 \times 0.95} < \text{rating current of fuse}$$

$2.255 < \text{rating current of fuse}$

■ Determination of the type of fuse

e.g.Condition:

- ◆ Calculating value = 2.255 A , 2.255A < rating current of fuse
- ◆ Normal operating voltage : DC 12 V
- ◆ Following bottom index-table: suggesting use CF06V3T2R50.

Part Designation	Marking	Rated Current	Rated Voltage	Part Designation	Marking	Rated Current	Rated Voltage	Part Designation	Marking	Rated Current	Rated Voltage
CF04V3TR315	D	0.315A	32V	CF06V5TR40	E	0.4A	50V	CF12V6TR50	F	0.50A	63V
CF04V3TR50	F	0.5A	32V	CF06V5TR50	F	0.5A	50V	CF12V6TR80	K	0.80A	63V
CF04V3TR75	V	0.75A	32V	CF06V3TR63	I	0.63A	32V	CF12V6T1R0	L	1.00A	63V
CF04V3TR80	K	0.80A	32V	CF06V3TR80	K	0.80A	32V	CF12V6T1R25	<u>M</u>	1.25A	63V
CF04V3T1R0	L	1.00A	32V	CF06V3T1R0	L	1.00A	32V	CF12V6T1R50	P	1.50A	63V
CF04V3T1R25	<u>M</u>	1.25A	32V	CF06V3T1R25	<u>M</u>	1.25A	32V	CF12V6T2R0	S	2.00A	63V
CF04V3T1R50	P	1.50A	32V	CF06V3T1R50	P	1.50A	32V	CF12V3T2R50	T	2.50A	32V
CF04V3T1R60	N	1.60A	32V	CF06V3T1R60	N	1.60A	32V	CF12V3T3R00	3	3.00A	32V
CF04V3T2R0	S	2.00A	32V	CF06V3T2R0	S	2.00A	32V	CF12V3T4R0	W	4.00A	32V
CF04V3T2R50	T	2.50A	32V	CF06V3T2R50	T	2.50A	32V	CF12V3T5R0	Y	5.00A	32V
CF04V3T3R0	3	3.00A	32V	CF06V3T3R00	3	3.00A	32V	CF12V3T7R0	Z	7.00A	32V
CF04V3T3R15	U	3.15A	32V	CF06V3T3R15	U	3.15A	32V				
CF04V3T4R0	W	4.00A	32V	CF06V3T4R0	W	4.00A	32V				
				CF06V3T5R0	Y	5.00A	32V				

■ Inrush current:

- ◆ Considering inrush waveform & calculate I^2t (A²s) value
- ◆ Choosing fuse's I^2t (A²s) value > calculate I^2t (A²s) value
- ◆ Considering Ratio of I^2t repeat numbers to blowing .
- ◆ Confirm with us.

e.g., choosing 0603 Fuse

Condition:

1. Rectangular Wave, $I_p = 4$ A, $t = 1$ ms , calculate $I_p^2t = 4^2 \times 1 \times 10^{-3} = 0.016$ (A²s)
2. Choosing CF06V3T2R50, $I^2t = 0.055$ (A²s) → Page 12 index-table



Thin Film Chip Fuse



Document No	TCF-XX0S032N
Issued date	2023/07/21
Page	12/19

- Inrush shock : 100,000 times (≈ 0.35) → inrush ratio
- Choosing fuse's I^2t (A^2s) value X Derating ratio (inrush 100000 times) > calculate I^2t (A^2s) value
- $0.055 \times 0.35 = 0.01925$ (A^2s) > 0.016 → CF06V3T2R50 is able to meet circuit's application

TA-I FUSE I^2t (A^2s)					
Part Number	Typical I^2t (A^2s)*	Part Number	Typical I^2t (A^2s)*	Part Number	Typical I^2t (A^2s)*
CF04V3TR315	0.00203	CF06V5TR40	0.004	CF12V6TR50	0.011
CF04V3TR50	0.00317	CF06V5TR50	0.005	CF12V6TR80	0.031
CF04V3TR75	0.00402	CF06V3TR63	0.007	CF12V6T1R0	0.034
CF04V3TR80	0.00532	CF06V3TR80	0.014	CF12V6T1R25	0.062
CF04V3T1R0	0.00724	CF06V3T1R0	0.016	CF12V6T1R50	0.144
CF04V3T1R25	0.01344	CF06V3T1R25	0.027	CF12V6T2R0	0.181
CF04V3T1R50	0.01356	CF06V3T1R50	0.037	CF12V3T2R50	0.351
CF04V3T1R60	0.01672	CF06V3T1R60	0.041	CF12V3T3R00	0.501
CF04V3T2R0	0.01983	CF06V3T2R0	0.044	CF12V3T4R0	0.954
CF04V3T2R50	0.03763	CF06V3T2R50	0.055	CF12V3T5R0	0.966
CF04V3T3R0	0.05427	CF06V3T3R00	0.082	CF12V3T7R0	3.250
CF04V3T3R15	0.06304	CF06V3T3R15	0.089		
CF04V3T4R0	0.08960	CF06V3T4R0	0.239		
		CF06V3T5R0	0.433		

Note*: Typical I^2t value is measured at 10x-rated current, Application with surge over 10x-rated current. Please confirm with us.

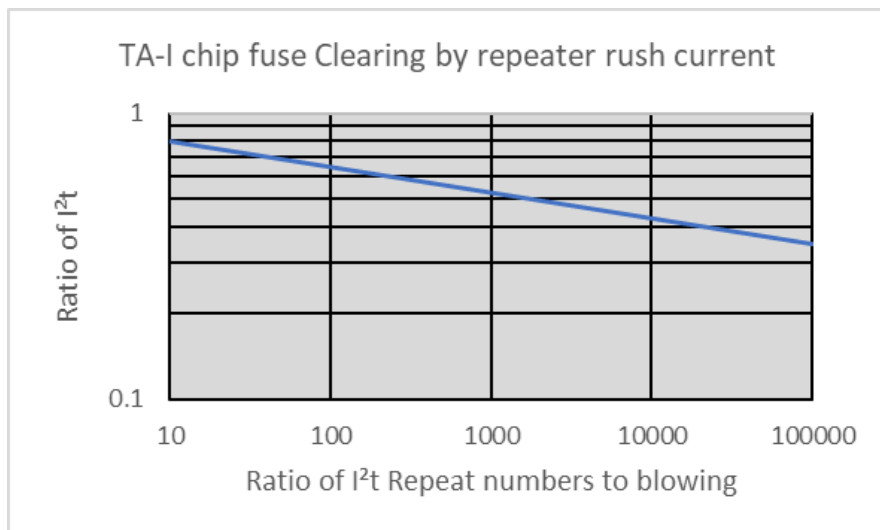



Thin Film Chip Fuse



Document No	TCF-XX0S032N
Issued date	2023/07/21
Page	13/19

No.	Type	Waveform	Formula
1	Sinusoidal Waveform (1 Cycle)		$\frac{1}{2} I_m^2 t$
2	Sinusoidal Waveform (1/2 Cycle)		$\frac{1}{2} I_m^2 t$
3	Triangle Waveform		$\frac{1}{3} I_m^2 t$
4	Rectangular Waveform		$I_m^2 t$
5	Trapezoidal Waveform		$\frac{1}{3} I_m^2 t + I_m^2 (t_1 - t_2) + \frac{1}{3} I_m^2 (t_2 - t_3)$
6	Various Waveform 1		$I_1 I_2 t + \frac{1}{3} (I_1 - I_2)^2 t$
7	Various Waveform 2		$I_1 I_2 t + \left[I_1 I_2 t + \frac{(I_1 - I_2)^2}{3} \right] * (t_2 - t_1) + \frac{1}{3} (I_2)^2 (t_3 - t_2)$
8	Charge/Discharge Waveform		$\frac{1}{2} (I_m^2 \tau)$
9	Lightning Surge Waveform		$I_m^2 \left[\frac{t_1}{3} + 0.721 (t_2 - t_1) \right]$



Thin Film Chip Fuse



Document No	TCF-XX0S032N
Issued date	2023/07/21
Page	14/19

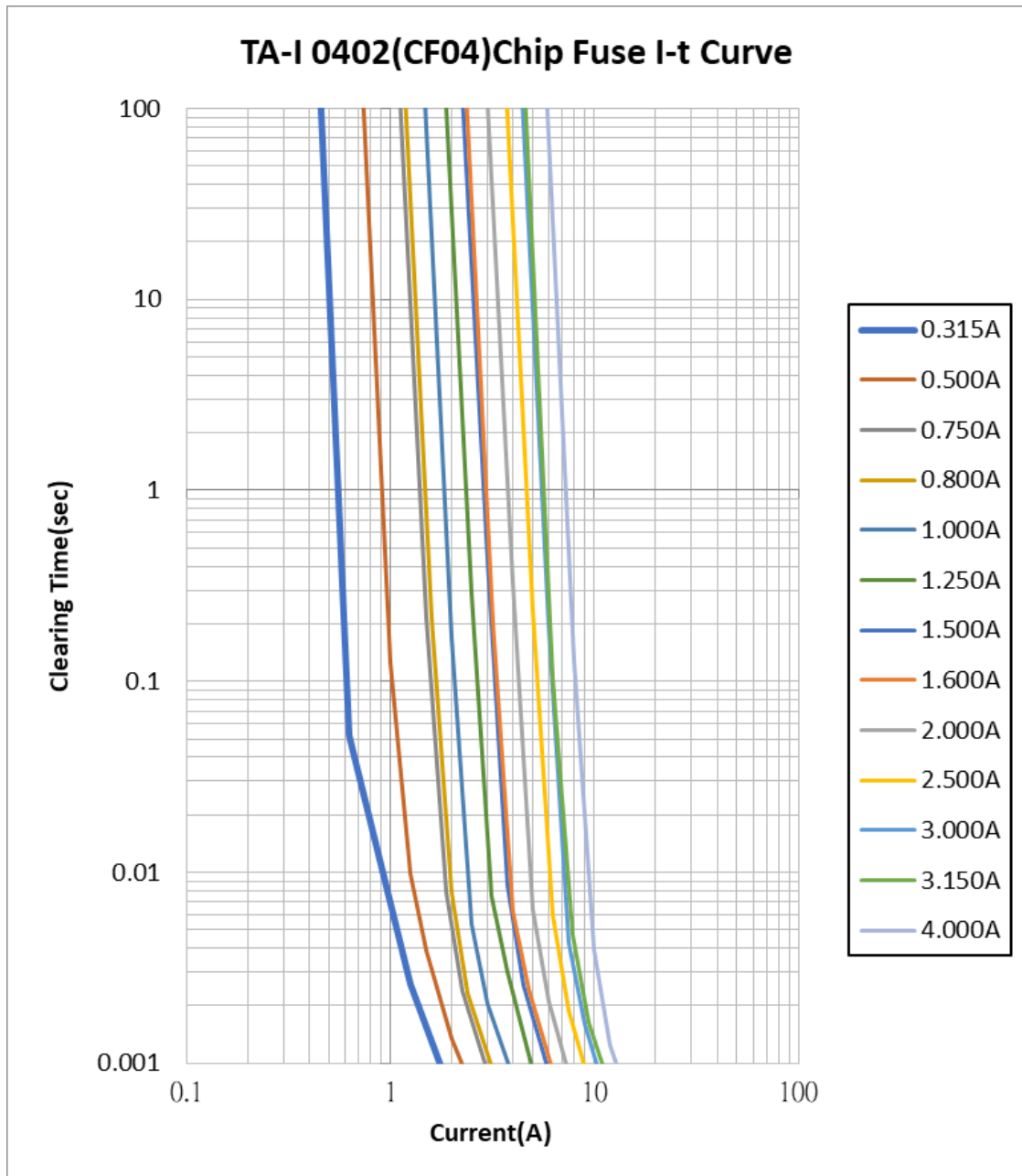



Thin Film Chip Fuse



Document No	TCF-XX0S032N
Issued date	2023/07/21
Page	15/19

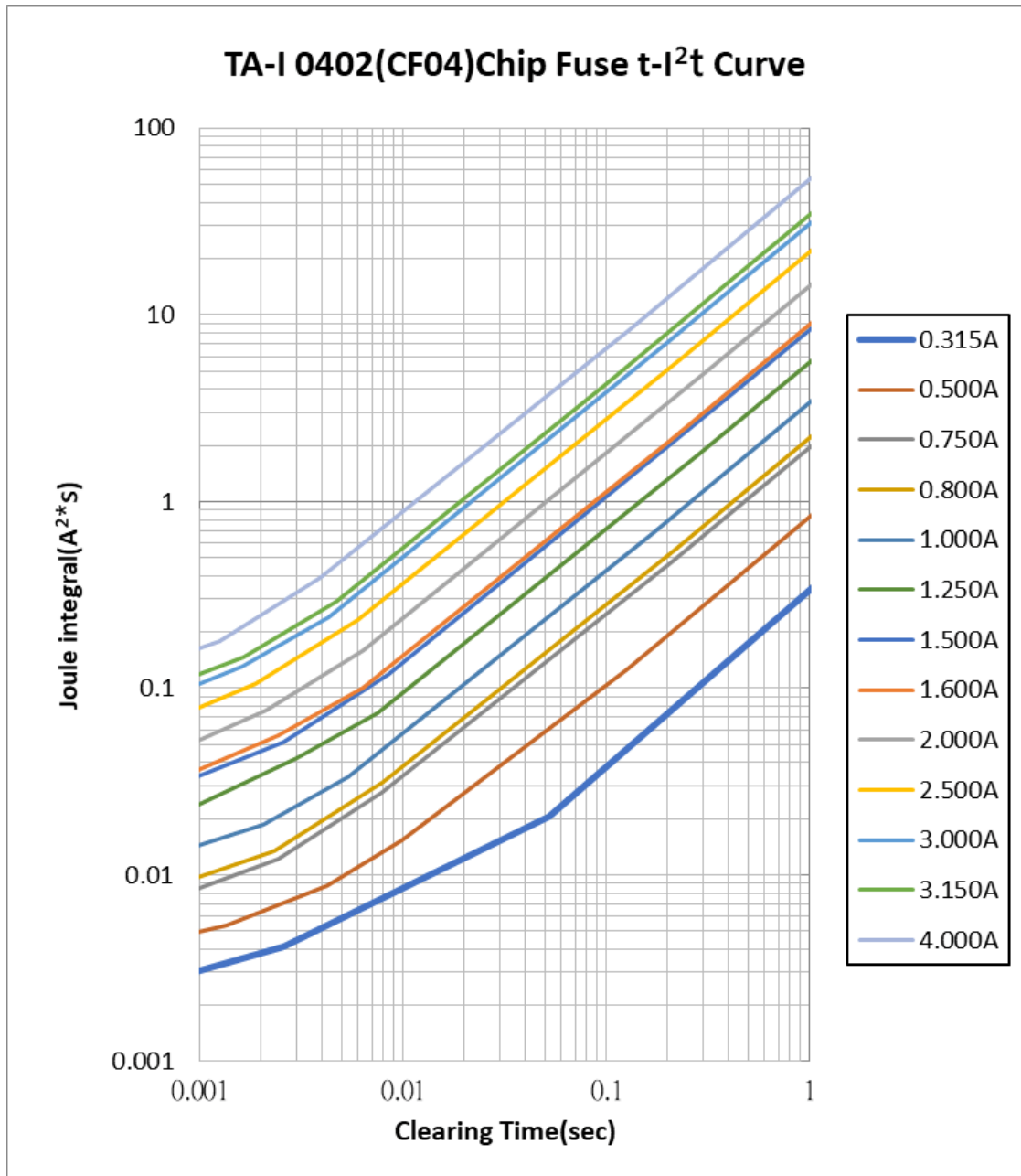



Thin Film Chip Fuse



Document No	TCF-XX0S032N
Issued date	2023/07/21
Page	16/19

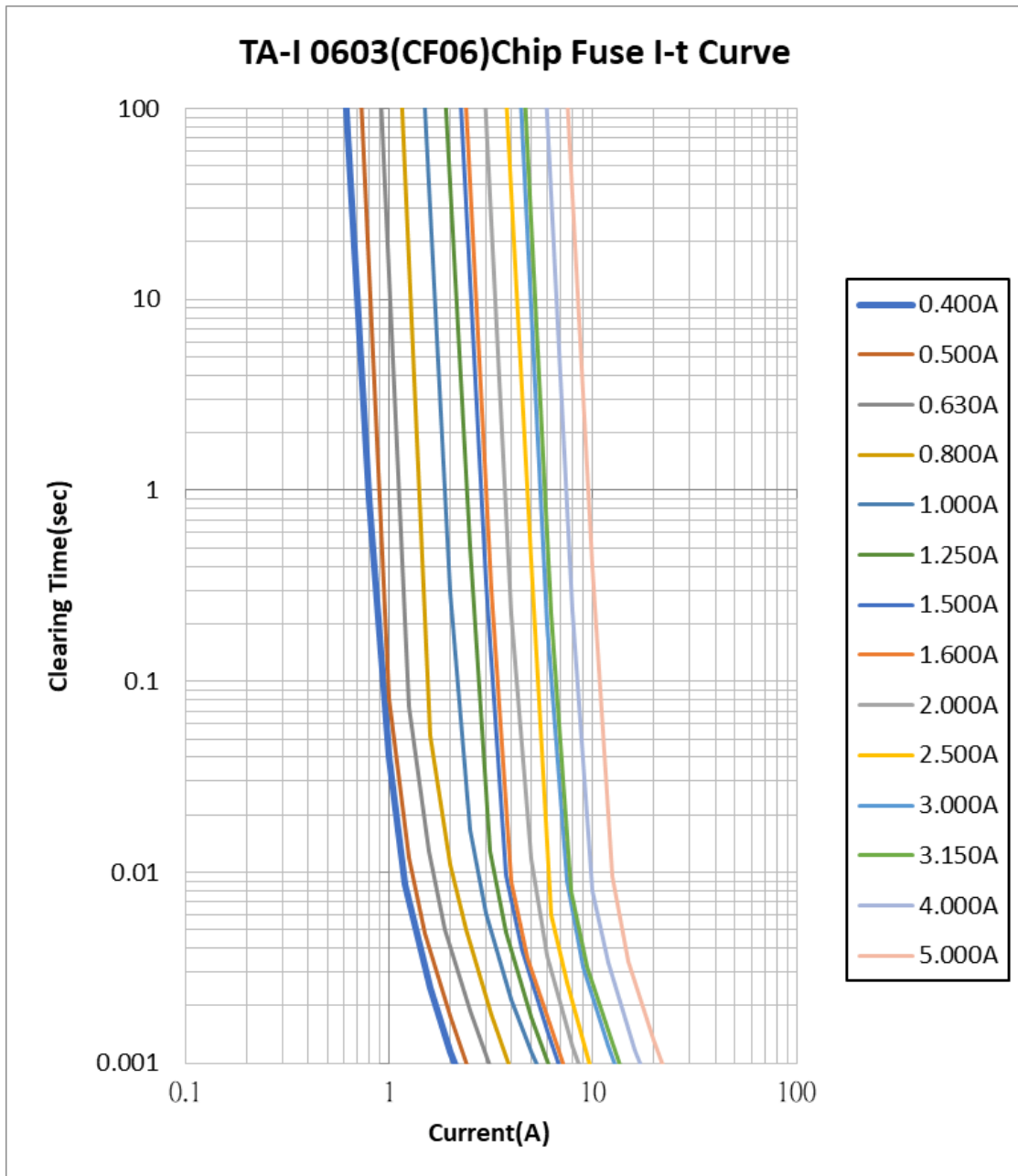



Thin Film Chip Fuse



Document No	TCF-XX0S032N
Issued date	2023/07/21
Page	17/19

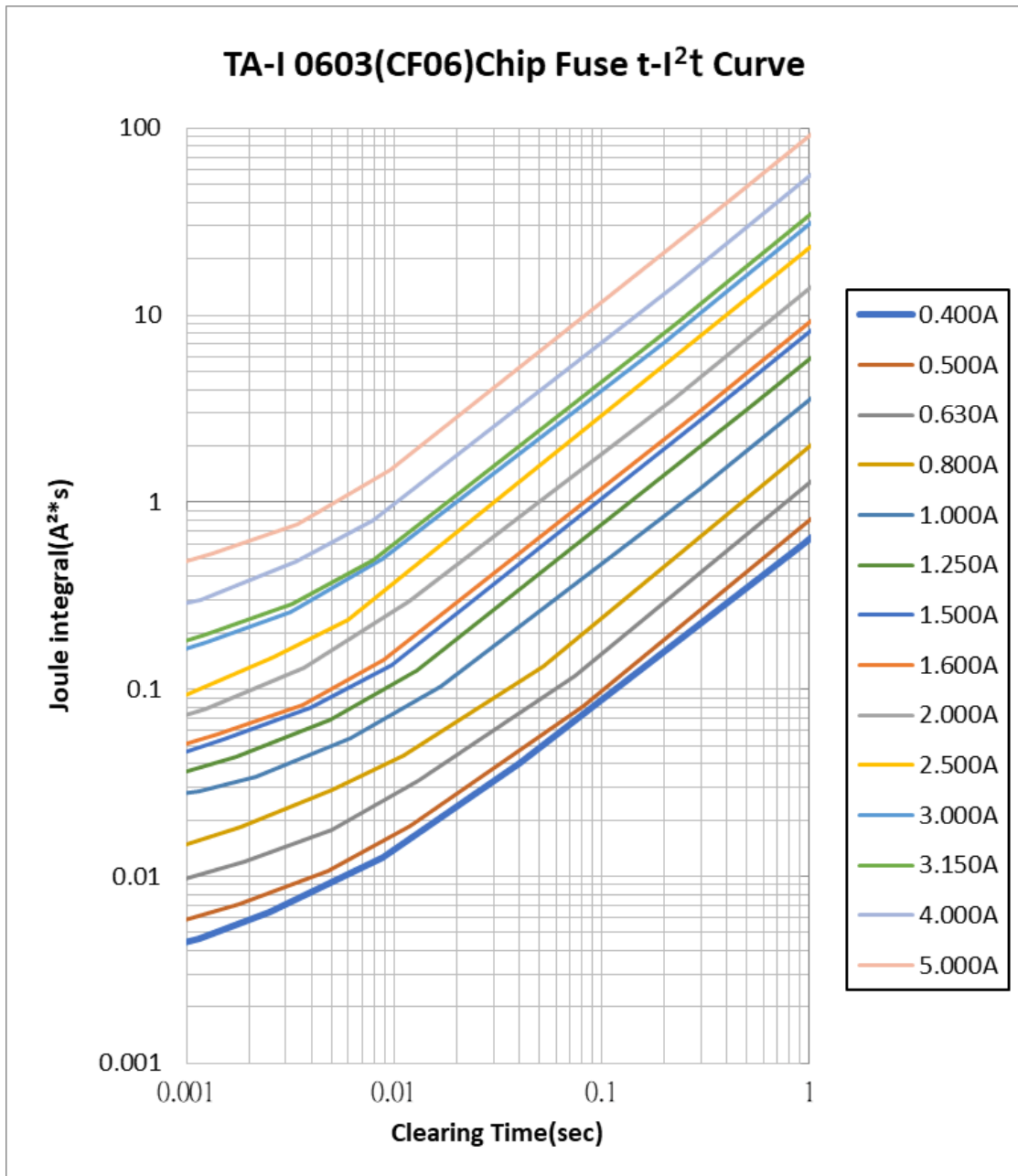



Thin Film Chip Fuse



Document No	TCF-XX0S032N
Issued date	2023/07/21
Page	18/19

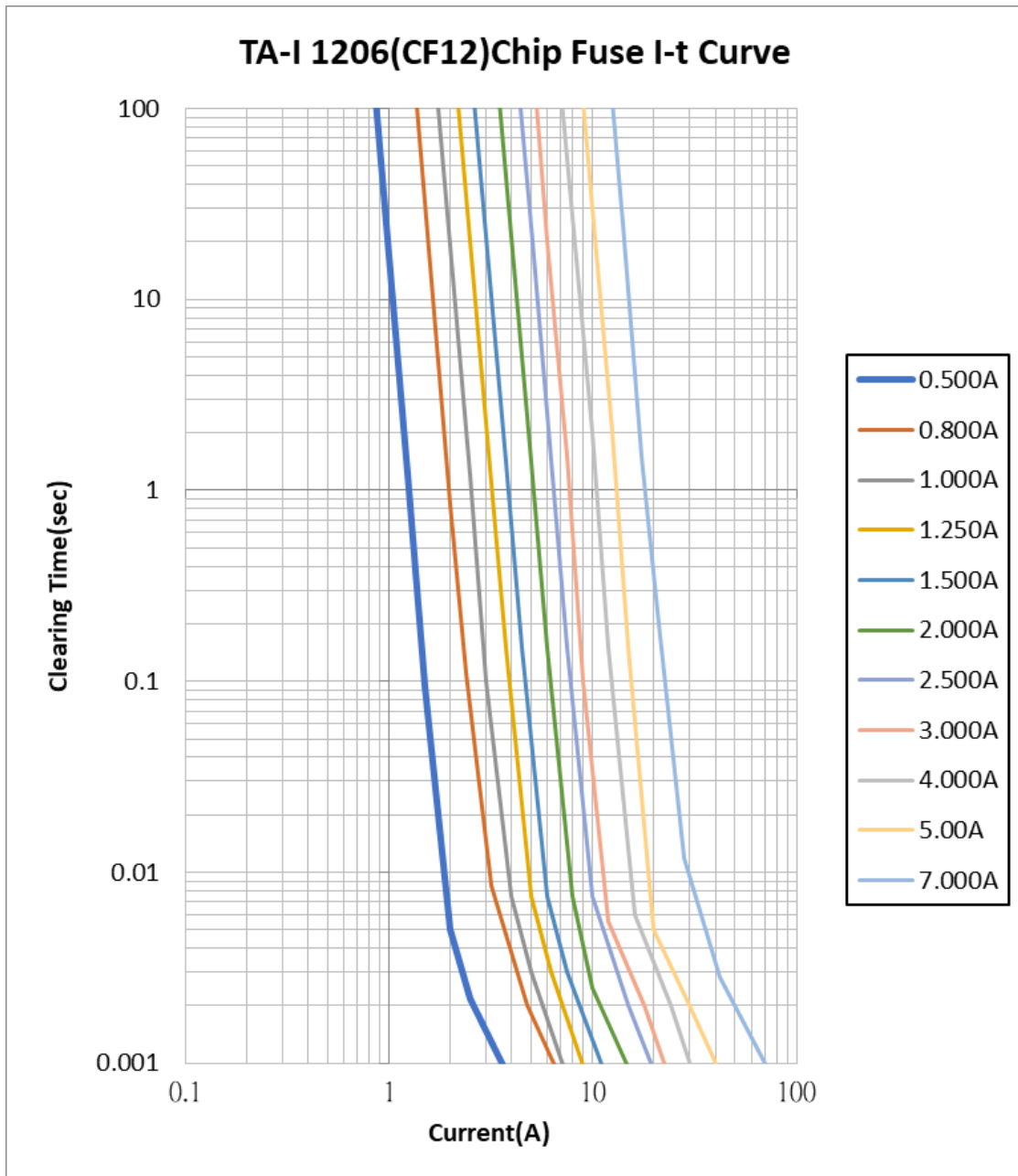



Thin Film Chip Fuse



Document No	TCF-XX0S032N
Issued date	2023/07/21
Page	19/19

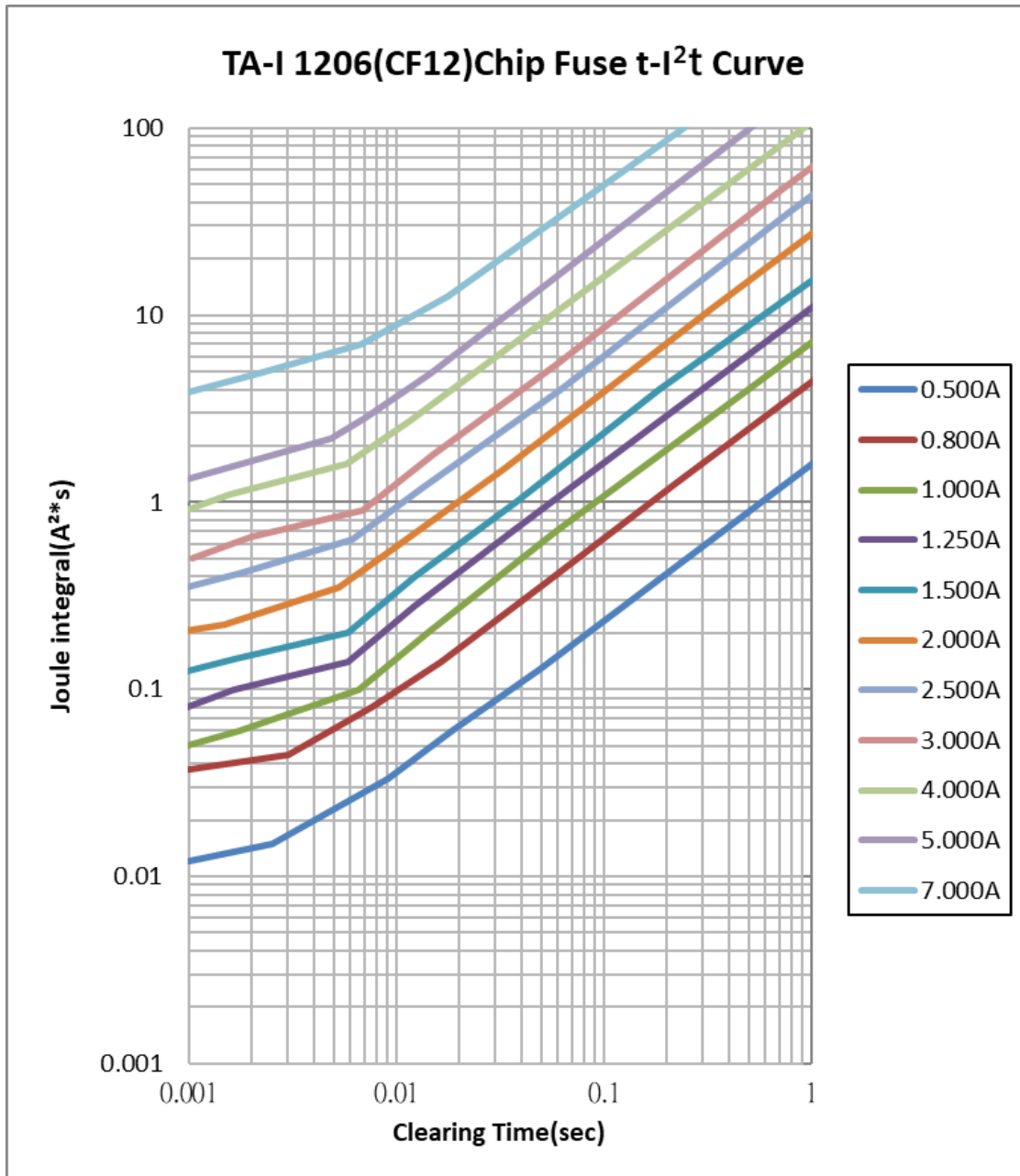

单击下面可查看定价，库存，交付和生命周期等信息

[>>TA-I\(大毅\)](#)