



Thin Film Chip Fuse



| | |
|-------------|--------------|
| Document No | TCF-XX0S032N |
| Issued date | 2023/07/21 |
| Page | 1/19 |

1. Scope

This specification applies for the fuse series of thin film chip fuse made by TA-I.

2. Construction

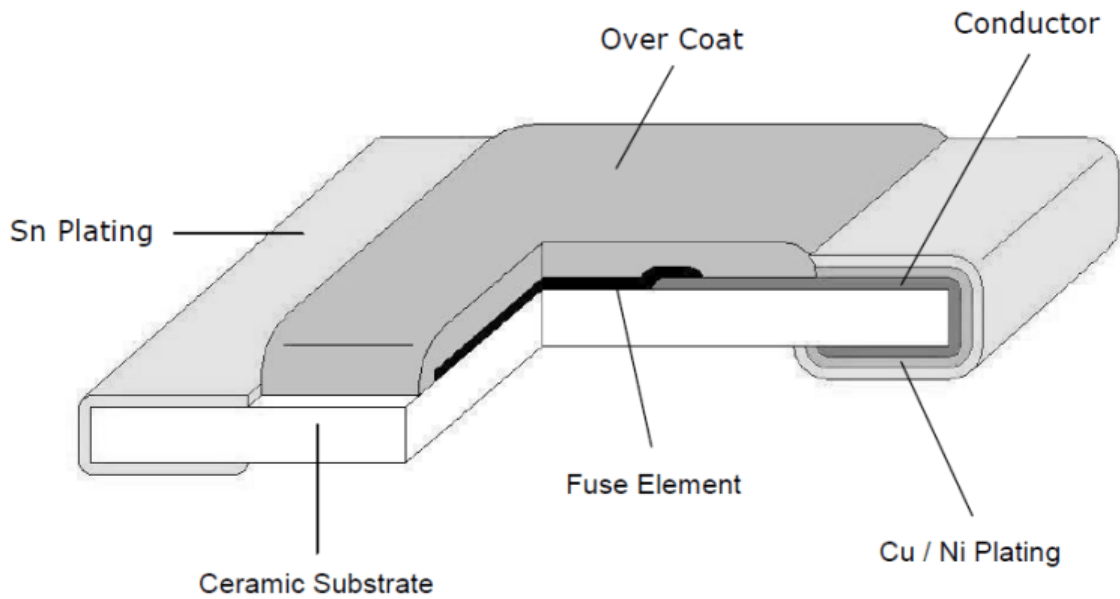

3. Type Designation

| CF | 06 | V5 | T | R50 |
|-----------|---|----------------------------|---------------------------|--------------------|
| | Size | Rate Voltage | Packaging | Rate Current |
| Chip Fuse | 04:0402(1005) 06:0603(1608) 12:1206(3216) | V6:63V V5:50V V3:32V | T: Paper Tape (5K/10K) | R50:0.5A 1R0:1A |



Thin Film Chip Fuse



| | |
|-------------|--------------|
| Document No | TCF-XX0S032N |
| Issued date | 2023/07/21 |
| Page | 2/19 |

4. Dimensions

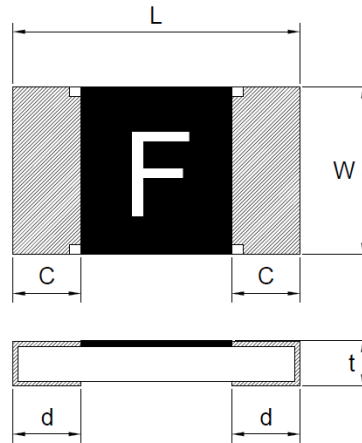

Unit: mm

| Type (Inch Size code) | Dimensions (mm) | | | | |
|--------------------------|-----------------|-----------|---------|----------|-----------|
| | L | W | C | d | t |
| CF04 (0402) | 1.0±0.1 | 0.52±0.05 | 0.2±0.1 | 0.25±0.1 | 0.35±0.05 |
| CF06 (0603) | 1.6±0.1 | 0.80±0.10 | 0.3±0.2 | 0.35±0.2 | 0.45±0.10 |
| CF12 (1206) | 3.1±0.1 | 1.55±0.10 | 0.5±0.3 | 0.50±0.2 | 0.60±0.10 |

5. Applications and ratings

| Part Designation | Marking | Rated Current | Fusing Time | Resistance (mΩ) Tolerance (±25%) | Rated Voltage | Breaking Capacity | Body Temperature rising |
|------------------|---------|---------------|--|-------------------------------------|---------------|-------------------|-----------------------------------|
| CF04V3TR315 | D | 0.315A | Open within 1min.at 200% rated current | 690 | DC 32V | DC32V 35A | <75°C at 100% rated current |
| CF04V3TR50 | F | 0.500A | | 340 | | | |
| CF04V3TR75 | V | 0.750A | | 140 | | | |
| CF04V3TR80 | K | 0.800A | | 100 | | | |
| CF04V3T1R0 | L | 1.000A | | 95 | | | |
| CF04V3T1R25 | M | 1.250A | | 57 | | | |
| CF04V3T1R50 | P | 1.500A | | 45 | | | |
| CF04V3T1R60 | N | 1.600A | | 44 | | | |
| CF04V3T2R0 | S | 2.000A | | 33 | | | |
| CF04V3T2R50 | T | 2.500A | | 25 | | | |
| CF04V3T3R0 | 3 | 3.000A | | 19 | | | |
| CF04V3T3R15 | U | 3.150A | | 18 | | | |
| CF04V3T4R0 | W | 4.000A | | 12 | | | |

*Resistance value was measured with less than 10% of rated current



Thin Film Chip Fuse



| | |
|-------------|--------------|
| Document No | TCF-XX0S032N |
| Issued date | 2023/07/21 |
| Page | 3/19 |

| Part Designation | Marking | Rated Current | Fusing Time | Resistance (mΩ) Tolerance (±25%) | Rated Voltage | Breaking Capacity | Body Temperature rising |
|------------------|----------|---------------|---|-------------------------------------|---------------|-------------------|-----------------------------|
| CF06V5TR40 | E | 0.40A | Open within 1min. at 200% rated current | 496 | DC 50V | DC50V 50A | <75°C at 100% rated current |
| CF06V5TR50 | F | 0.50A | | 290 | | | |
| CF06V3TR63 | I | 0.63A | | 205 | DC 32V | DC32V 50A | |
| CF06V3TR80 | K | 0.80A | | 132 | | | |
| CF06V3T1R0 | L | 1.00A | | 84 | | | |
| CF06V3T1R25 | <u>M</u> | 1.25A | | 63 | | | |
| CF06V3T1R50 | P | 1.50A | | 50.5 | | | |
| CF06V3T1R60 | N | 1.60A | | 45 | | | |
| CF06V3T2R0 | S | 2.00A | | 34 | DC 32V | DC32V 50A | |
| CF06V3T2R50 | T | 2.50A | | 24.5 | | | |
| CF06V3T3R00 | 3 | 3.00A | | 20 | | | |
| CF06V3T3R15 | U | 3.15A | | 19 | | | |
| CF06V3T4R0 | W | 4.00A | | 13 | | | |
| CF06V3T5R0 | Y | 5.00A | | 11 | | | |

*Resistance value was measured with less than 10% of rated current

| Part Designation | Marking | Rated Current | Fusing Time | Resistance (mΩ) Tolerance±25% | Rated Voltage | Breaking Capacity | Body Temperature rising |
|------------------|----------|---------------|---|----------------------------------|---------------|-------------------|-----------------------------|
| CF12V6TR50 | F | 0.50A | Open within 1min. at 200% rated current | 517 | DC 63V | DC63V 50A | <75°C at 100% rated current |
| CF12V6TR80 | K | 0.80A | | 211 | | | |
| CF12V6T1R0 | L | 1.00A | | 132 | | | |
| CF12V6T1R25 | <u>M</u> | 1.25A | | 95 | | | |
| CF12V6T1R50 | P | 1.50A | | 76 | | | |
| CF12V6T2R0 | S | 2.00A | | 40.5 | DC 32V | DC32V 50A | |
| CF12V3T2R50 | T | 2.50A | | 31.5 | | | |
| CF12V3T3R00 | 3 | 3.00A | | 23.25 | | | |
| CF12V3T4R0 | W | 4.00A | | 16 | | | |
| CF12V3T5R0 | Y | 5.00A | | 12 | | | |
| CF12V3T7R0 | Z | 7.00A | | 7.5 | | | |

*Resistance value was measured with less than 10% of rated current



Thin Film Chip Fuse



| | |
|-------------|--------------|
| Document No | TCF-XX0S032N |
| Issued date | 2023/07/21 |
| Page | 4/19 |

6 Temperature Derating Curve

6.1 Normal Ambient Temperature: 25°C

6.2 Operating Temperature: -20°C ~105°C , with proper derating factor as below:

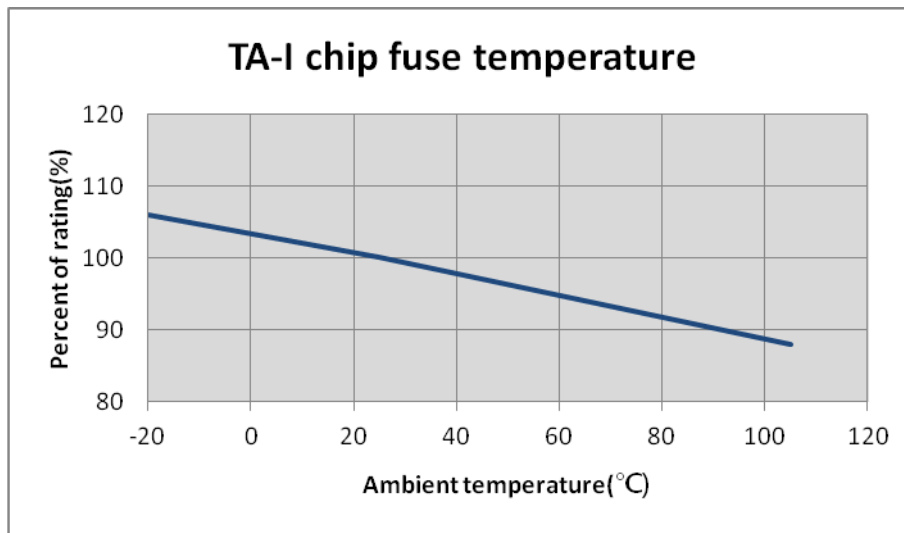

7 Reliability Tests

| Parameter | Requirement | Test Method |
|---------------------------|--|--|
| Carrying capacity | No fusing | Rated current ,4hr |
| Fusing Time | Within 1 minute | 200% of its rated current |
| Interrupting Ability | No mechanical damages | After the fuse is interrupted, rated voltage applied for 30sec again |
| Bending Test | No mechanical damages | Distance between holding points: 90mm, Bending:3mm,1time ,30sec |
| Resistance to solder Heat | ±20% | 260°C±5°C ,10±1second |
| Solderability | 95% coverage minimum | 235°C±5°C , 2±0.5second 245°C±5°C , 2±0.5second (Lead Free) |
| Temperature Rise | <75°C | 100% of its rated current, Measure of surface temperature |
| Resistance to Dry Heat | ±20% | 105°C±5°C ,1000 hrs |
| Resistance to Solvent | No evident damages on protective coating and marking | 23°C±5°C of Isopropyl alcohol 90second |
| Residual Resistance | 10kΩ and more | Measure DC resistance after fusing |
| Thermal Shock | ΔR< 10 % | -20°C/+25°C/+125°C/+25°C , 10 cycles |



Thin Film Chip Fuse



| | |
|-------------|--------------|
| Document No | TCF-XX0S032N |
| Issued date | 2023/07/21 |
| Page | 5/19 |

8 Taping & Reel

8.1 Taping Dimensions

4mm pitch paper

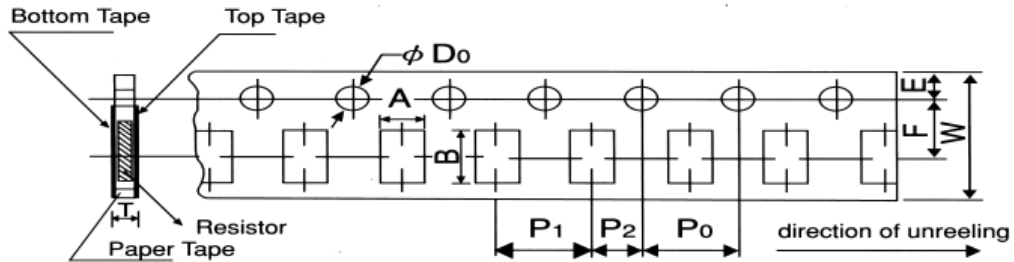

| Packing | Type | A | B | W | F | E | P ₁ | P ₂ | P ₀ | D ₀ | T |
|------------|------|----------|----------|---------|----------|----------|----------------|----------------|----------------|--|----------|
| Paper Tape | CF04 | 0.7±0.05 | 1.2±0.05 | 8.0±0.2 | 3.5±0.05 | 1.75±0.1 | 2.0±0.1 | 2.0±0.05 | 4.0±0.1 | $\phi \begin{matrix} +0.1 \\ 1.5 \\ 0 \end{matrix}$ | 0.45±0.1 |
| Paper Tape | CF06 | 1.1±0.1 | 1.9±0.1 | 8.0±0.2 | 3.5±0.05 | 1.75±0.1 | 4.0±0.1 | 2.0±0.05 | 4.0±0.1 | $\phi \begin{matrix} +0.1 \\ 1.5 \\ -0 \end{matrix}$ | 0.64±0.1 |
| Paper Tape | CF12 | 2.0±0.15 | 3.6±0.2 | 8.0±0.2 | 3.5±0.05 | 1.75±0.1 | 4.0±0.1 | 2.0±0.05 | 4.0±0.1 | $\phi \begin{matrix} +0.1 \\ 1.5 \\ -0 \end{matrix}$ | 0.84±0.1 |

Unit: mm

| Type Size | | Paper Tape |
|-----------|----|------------|
| | | 2 mm pitch |
| | | 180mm/R |
| CF | 04 | 10000 |

| Type series | | Paper Tape |
|-------------|----|------------|
| | | 4 mm pitch |
| | | 180mm/R |
| CF | 06 | 5000 |
| CF | 12 | 5000 |



Thin Film Chip Fuse



| | |
|-------------|--------------|
| Document No | TCF-XX0S032N |
| Issued date | 2023/07/21 |
| Page | 6/19 |

8.2 Reel Specifications

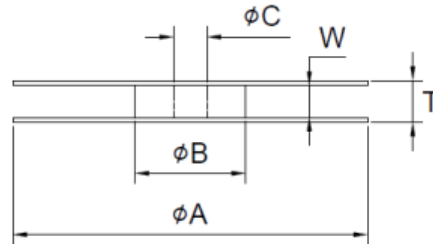

Unit: mm

| Series | ϕA | ϕB | ϕC | W | T |
|----------------------|----------|----------|----------|---------|----------|
| CF04 CF06 CF12 | 178 ±2.0 | 60.0±1.0 | 13.0±1.0 | 9.0±1.0 | 11.4±2.0 |

8.3 Peel –off force:

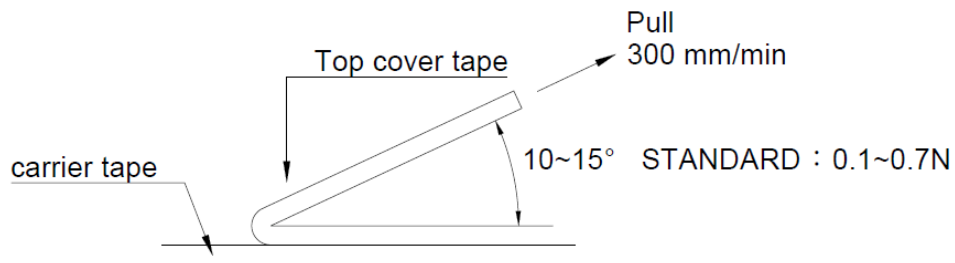

9 Storage Conditions:

Temperature: 5°C~35°C, Humidity:40%~75%

10 Shelf Life:

2 years from manufacturing date



Thin Film Chip Fuse



| | |
|-------------|--------------|
| Document No | TCF-XX0S032N |
| Issued date | 2023/07/21 |
| Page | 7/19 |

11 Label

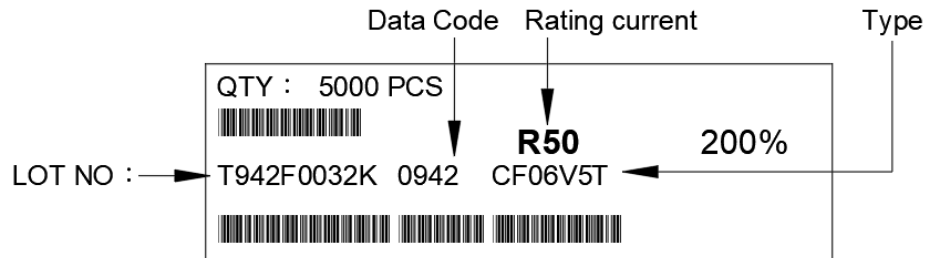

12 Recommended land patterns

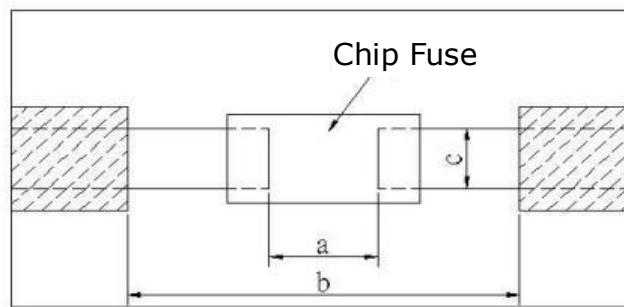

| Type | Land pattern Size | Dimension | | |
|------|----------------------|-----------|-----------|-----------|
| | | a | b | c |
| CF | 04 (0402) | 0.55~0.65 | 1.40~1.60 | 0.74~0.94 |
| CF | 06 (0603) | 0.85~0.95 | 2.00~2.20 | 1.50~1.70 |
| CF | 12 (1206) | 0.95~1.05 | 4.40~5.00 | 2.30~2.50 |



Thin Film Chip Fuse



| | |
|-------------|--------------|
| Document No | TCF-XX0S032N |
| Issued date | 2023/07/21 |
| Page | 8/19 |

13. Recommend IR – Reflow profile: (solder: Sn96.5 / Ag3 / Cu0.5)

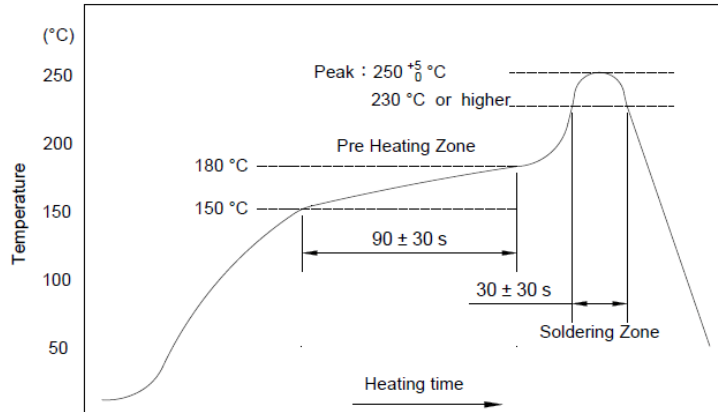

Peak : $250 \pm 5/0$ °C , 5 sec.

Pre-heat Zone : 150 to 180 °C , 90 ± 30 sec

Soldering Zone : 230°C or higher , 30 ± 10 sec

14. Approval by UL248-14

The fuses have been approved by UL.

File No. of UL Recognition is E241710

15. ECN

Engineering Change Notice: The customer will be informed with ECN if there is significant modification on the characteristics and materials described in Approval Sheet.

16. Manufacturing Country & City:

TA-I TECHNOLOGY CO., LTD. (Taiwan– Tao Yuan)

Tel: (+886) 3-3246169 Fax: (+886) 3-3246167

Associated companies:

(1) TA-I TECHNOLOGY (SU ZHOU) CO., LTD. (China – Su Zhou)

Tel: (+86) 512-63457879 Fax: (+86) 512-63457869

(2) TA-I TECHNOLOGY ELECTRONIC (DONGGUAN) CO., LTD. (China –Dongguan)

Tel: (+86) 769-8339-4790~3 Fax: (+86) 769-8339-4794

(3) FORTUNE TASK RESISTOR FACTORY (China – Dongguan)

Tel: (+86) 769-8339-4790~3 Fax: (+86) 769-8339-4794

(4) TAI OHM ELECTRONICS (M) SDN. BHD. (Malaysia – Penang)

Tel: (+60) 4- 3900480 Fax: (+60) 4-3901481



Thin Film Chip Fuse



| | |
|-------------|--------------|
| Document No | TCF-XX0S032N |
| Issued date | 2023/07/21 |
| Page | 9/19 |

17. Selection Guideline of Fuse:

■ Checklist of selection factors

- ⊙ Normal operating current
- ⊙ Normal operating voltage (AC or DC)
- ⊙ Ambient Temperature
- ⊙ Overload current and length of time in which the fuse must open .
- ⊙ Type of fuse (SMD or Tube) and physical size limitation (0603 or 1206)
- ⊙ Agency Approval required (e.g., UL248-14)

■ Normal operating current

e.g., Rectangular Wave, If $I_p = 1.5 \text{ A}$, Normal operating current = 1.5 A

| No. | Type | Waveform | Formula |
|-----|------------------------|----------|--|
| 1 | Sinusoidal Waveform | | $\frac{1}{\sqrt{2}} I_m \cong 0.707 I_m$ |
| 2 | All Wave Rectification | | $\frac{1}{\sqrt{2}} I_m \cong 0.707 I_m$ |
| 3 | Half Wave | | $0.5 I_m$ |
| 4 | Triangle Waveform | | $\frac{1}{3} I_m \cong 0.577 I_m$ |
| 5 | Rectangular Waveform | | I_m |
| 6 | Trapezoidal Waveform | | $I_m \sqrt{1 - \frac{8\alpha}{3T}}$ |



Thin Film Chip Fuse



| | |
|-------------|--------------|
| Document No | TCF-XX0S032N |
| Issued date | 2023/07/21 |
| Page | 10/19 |

| No. | Type | Waveform | Formula |
|-----|-------------------|----------|------------------------------|
| 7 | Rectangular Pulse | | $I_m \sqrt{\frac{\tau}{T}}$ |
| 8 | Triangle Pulse | | $I_m \sqrt{\frac{\tau}{3T}}$ |

Derating ratio for different ambient Temperature

- Referring to bottom figure and select the appropriate derating ratio :
e.g., Ambient temperature is 60 degree C
the derating ratio \approx 0.95

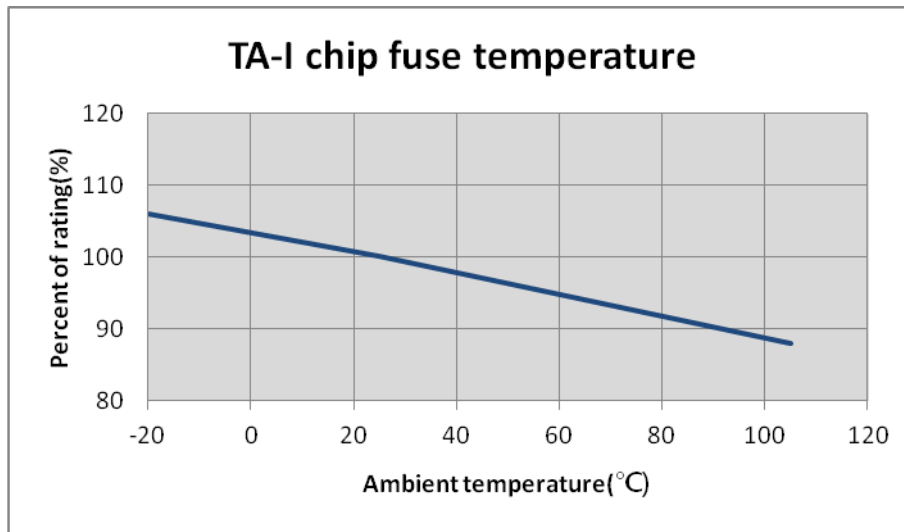

Calculating the required rating of fuse needed.

- Safety coefficient: 70% is safety coefficient from practical experience

- $$\frac{\text{Normal Operating Current}}{0.7 \times \text{derating ratio}} < \text{rating current of fuse}$$

- e.g.

Condition: Normal operating current = 1.5 A

Ambient temperature 40 °C : Derating ratio \approx 0.95



Thin Film Chip Fuse



| | |
|-------------|--------------|
| Document No | TCF-XX0S032N |
| Issued date | 2023/07/21 |
| Page | 11/19 |

$$\frac{1.5}{0.7 \times 0.95} < \text{rating current of fuse}$$

| |
|---|
| $2.255 < \text{rating current of fuse}$ |
|---|

■ Determination of the type of fuse

e.g.Condition:

- ◆ Calculating value = 2.255 A , 2.255A < rating current of fuse
- ◆ Normal operating voltage : DC 12 V
- ◆ Following bottom index-table: suggesting use CF06V3T2R50.

| Part Designation | Marking | Rated Current | Rated Voltage | Part Designation | Marking | Rated Current | Rated Voltage | Part Designation | Marking | Rated Current | Rated Voltage |
|------------------|----------|---------------|---------------|------------------|----------|---------------|---------------|------------------|----------|---------------|---------------|
| CF04V3TR315 | D | 0.315A | 32V | CF06V5TR40 | E | 0.4A | 50V | CF12V6TR50 | F | 0.50A | 63V |
| CF04V3TR50 | F | 0.5A | 32V | CF06V5TR50 | F | 0.5A | 50V | CF12V6TR80 | K | 0.80A | 63V |
| CF04V3TR75 | V | 0.75A | 32V | CF06V3TR63 | I | 0.63A | 32V | CF12V6T1R0 | L | 1.00A | 63V |
| CF04V3TR80 | K | 0.80A | 32V | CF06V3TR80 | K | 0.80A | 32V | CF12V6T1R25 | <u>M</u> | 1.25A | 63V |
| CF04V3T1R0 | L | 1.00A | 32V | CF06V3T1R0 | L | 1.00A | 32V | CF12V6T1R50 | P | 1.50A | 63V |
| CF04V3T1R25 | <u>M</u> | 1.25A | 32V | CF06V3T1R25 | <u>M</u> | 1.25A | 32V | CF12V6T2R0 | S | 2.00A | 63V |
| CF04V3T1R50 | P | 1.50A | 32V | CF06V3T1R50 | P | 1.50A | 32V | CF12V3T2R50 | T | 2.50A | 32V |
| CF04V3T1R60 | N | 1.60A | 32V | CF06V3T1R60 | N | 1.60A | 32V | CF12V3T3R00 | 3 | 3.00A | 32V |
| CF04V3T2R0 | S | 2.00A | 32V | CF06V3T2R0 | S | 2.00A | 32V | CF12V3T4R0 | W | 4.00A | 32V |
| CF04V3T2R50 | T | 2.50A | 32V | CF06V3T2R50 | T | 2.50A | 32V | CF12V3T5R0 | Y | 5.00A | 32V |
| CF04V3T3R0 | 3 | 3.00A | 32V | CF06V3T3R00 | 3 | 3.00A | 32V | CF12V3T7R0 | Z | 7.00A | 32V |
| CF04V3T3R15 | U | 3.15A | 32V | CF06V3T3R15 | U | 3.15A | 32V | | | | |
| CF04V3T4R0 | W | 4.00A | 32V | CF06V3T4R0 | W | 4.00A | 32V | | | | |
| | | | | CF06V3T5R0 | Y | 5.00A | 32V | | | | |

■ Inrush current:

- ◆ Considering inrush waveform & calculate I^2t (A²s) value
- ◆ Choosing fuse's I^2t (A²s) value > calculate I^2t (A²s) value
- ◆ Considering Ratio of I^2t repeat numbers to blowing .
- ◆ Confirm with us.

e.g., choosing 0603 Fuse

Condition:

1. Rectangular Wave, $I_p = 4$ A, $t = 1$ ms , calculate $I_p^2t = 4^2 \times 1 \times 10^{-3} = 0.016$ (A²s)
2. Choosing CF06V3T2R50, $I^2t = 0.055$ (A²s) → Page 12 index-table



Thin Film Chip Fuse



| | |
|-------------|--------------|
| Document No | TCF-XX0S032N |
| Issued date | 2023/07/21 |
| Page | 12/19 |

- Inrush shock : 100,000 times (≈ 0.35) \rightarrow inrush ratio
- Choosing fuse's I^2t (A^2s) value X Derating ratio (inrush 100000 times) > calculate I^2t (A^2s) value
- $0.055 \times 0.35 = 0.01925$ (A^2s) > 0.016 \rightarrow CF06V3T2R50 is able to meet circuit's application

| TA-I FUSE I^2t (A^2s) | | | | | |
|-----------------------------|----------------------------|-------------|----------------------------|-------------|----------------------------|
| Part Number | Typical I^2t (A^2s)* | Part Number | Typical I^2t (A^2s)* | Part Number | Typical I^2t (A^2s)* |
| CF04V3TR315 | 0.00203 | CF06V5TR40 | 0.004 | CF12V6TR50 | 0.011 |
| CF04V3TR50 | 0.00317 | CF06V5TR50 | 0.005 | CF12V6TR80 | 0.031 |
| CF04V3TR75 | 0.00402 | CF06V3TR63 | 0.007 | CF12V6T1R0 | 0.034 |
| CF04V3TR80 | 0.00532 | CF06V3TR80 | 0.014 | CF12V6T1R25 | 0.062 |
| CF04V3T1R0 | 0.00724 | CF06V3T1R0 | 0.016 | CF12V6T1R50 | 0.144 |
| CF04V3T1R25 | 0.01344 | CF06V3T1R25 | 0.027 | CF12V6T2R0 | 0.181 |
| CF04V3T1R50 | 0.01356 | CF06V3T1R50 | 0.037 | CF12V3T2R50 | 0.351 |
| CF04V3T1R60 | 0.01672 | CF06V3T1R60 | 0.041 | CF12V3T3R00 | 0.501 |
| CF04V3T2R0 | 0.01983 | CF06V3T2R0 | 0.044 | CF12V3T4R0 | 0.954 |
| CF04V3T2R50 | 0.03763 | CF06V3T2R50 | 0.055 | CF12V3T5R0 | 0.966 |
| CF04V3T3R0 | 0.05427 | CF06V3T3R00 | 0.082 | CF12V3T7R0 | 3.250 |
| CF04V3T3R15 | 0.06304 | CF06V3T3R15 | 0.089 | | |
| CF04V3T4R0 | 0.08960 | CF06V3T4R0 | 0.239 | | |
| | | CF06V3T5R0 | 0.433 | | |

Note*: Typical I^2t value is measured at 10x-rated current, Application with surge over 10x-rated current. Please confirm with us.

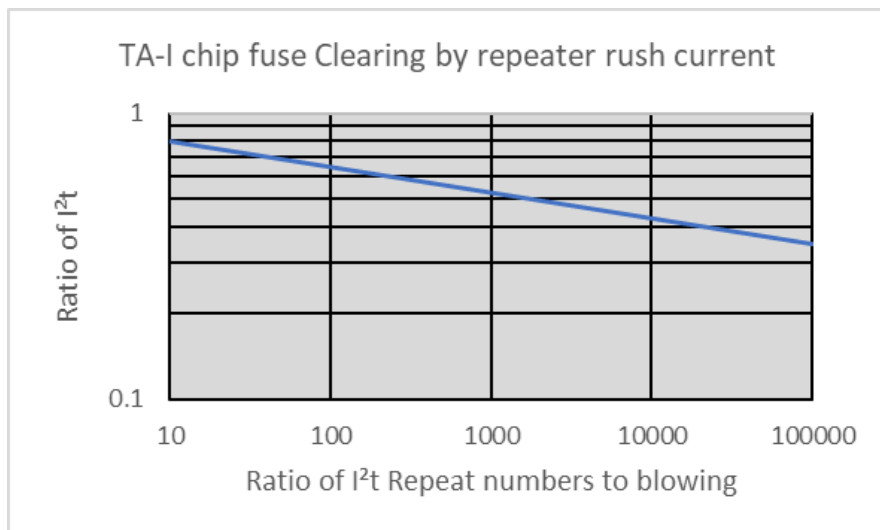



Thin Film Chip Fuse



| | |
|-------------|--------------|
| Document No | TCF-XX0S032N |
| Issued date | 2023/07/21 |
| Page | 13/19 |

| No. | Type | Waveform | Formula |
|-----|------------------------------------|----------|--|
| 1 | Sinusoidal Waveform (1 Cycle) | | $\frac{1}{2} I_m^2 t$ |
| 2 | Sinusoidal Waveform (1/2 Cycle) | | $\frac{1}{2} I_m^2 t$ |
| 3 | Triangle Waveform | | $\frac{1}{3} I_m^2 t$ |
| 4 | Rectangular Waveform | | $I_m^2 t$ |
| 5 | Trapezoidal Waveform | | $\frac{1}{3} I_m^2 t + I_m^2 (t_1 - t_2) + \frac{1}{3} I_m^2 (t_2 - t_3)$ |
| 6 | Various Waveform 1 | | $I_1 I_2 t + \frac{1}{3} (I_1 - I_2)^2 t$ |
| 7 | Various Waveform 2 | | $I_1 I_2 t + \left[I_1 I_2 t + \frac{(I_1 - I_2)^2}{3} \right] * (t_2 - t_1) + \frac{1}{3} (I_2)^2 (t_3 - t_2)$ |
| 8 | Charge/Discharge Waveform | | $\frac{1}{2} (I_m^2 \tau)$ |
| 9 | Lightning Surge Waveform | | $I_m^2 \left[\frac{t_1}{3} + 0.721 (t_2 - t_1) \right]$ |



Thin Film Chip Fuse



| | |
|-------------|--------------|
| Document No | TCF-XX0S032N |
| Issued date | 2023/07/21 |
| Page | 14/19 |

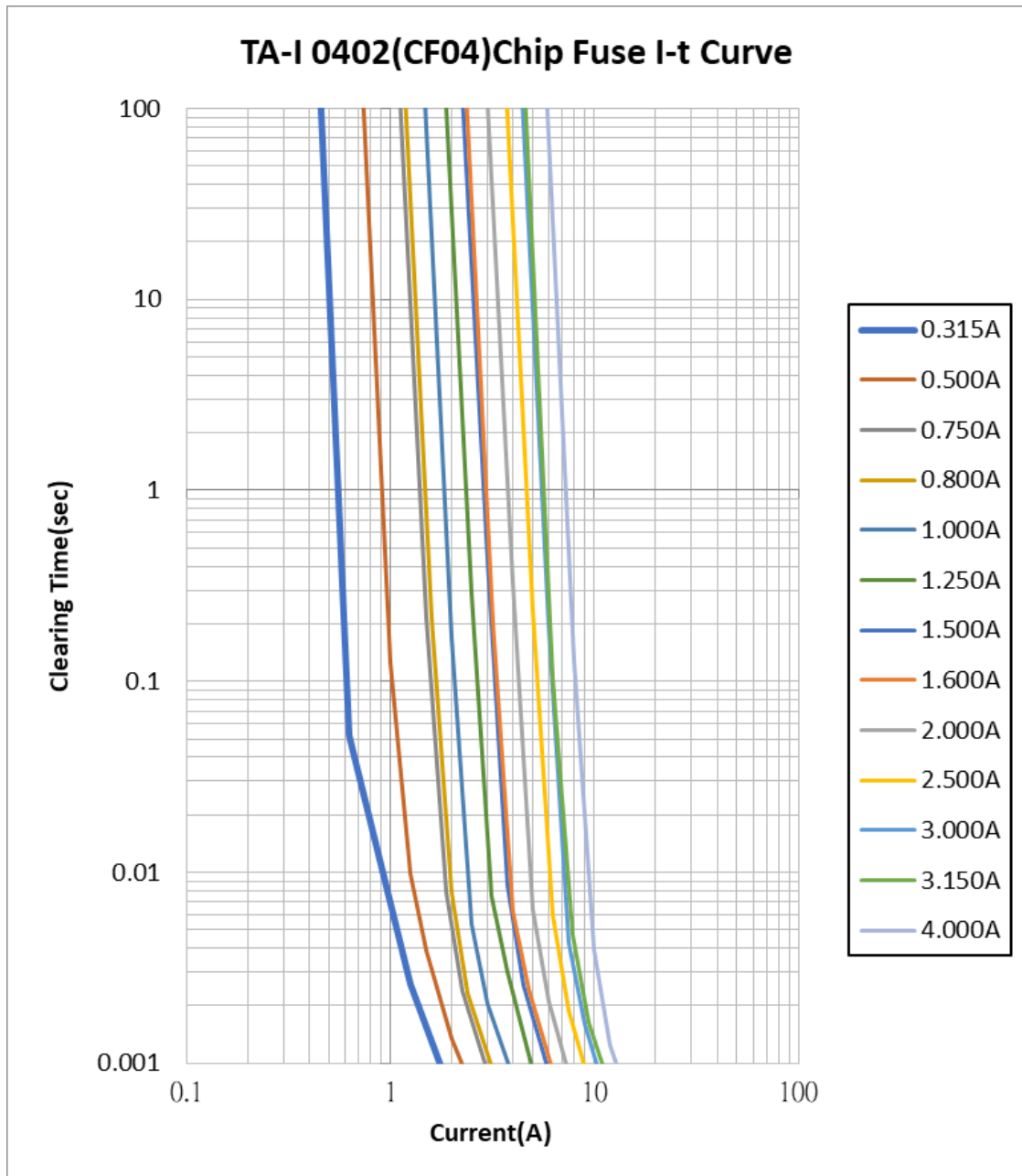



Thin Film Chip Fuse



| | |
|-------------|--------------|
| Document No | TCF-XX0S032N |
| Issued date | 2023/07/21 |
| Page | 15/19 |

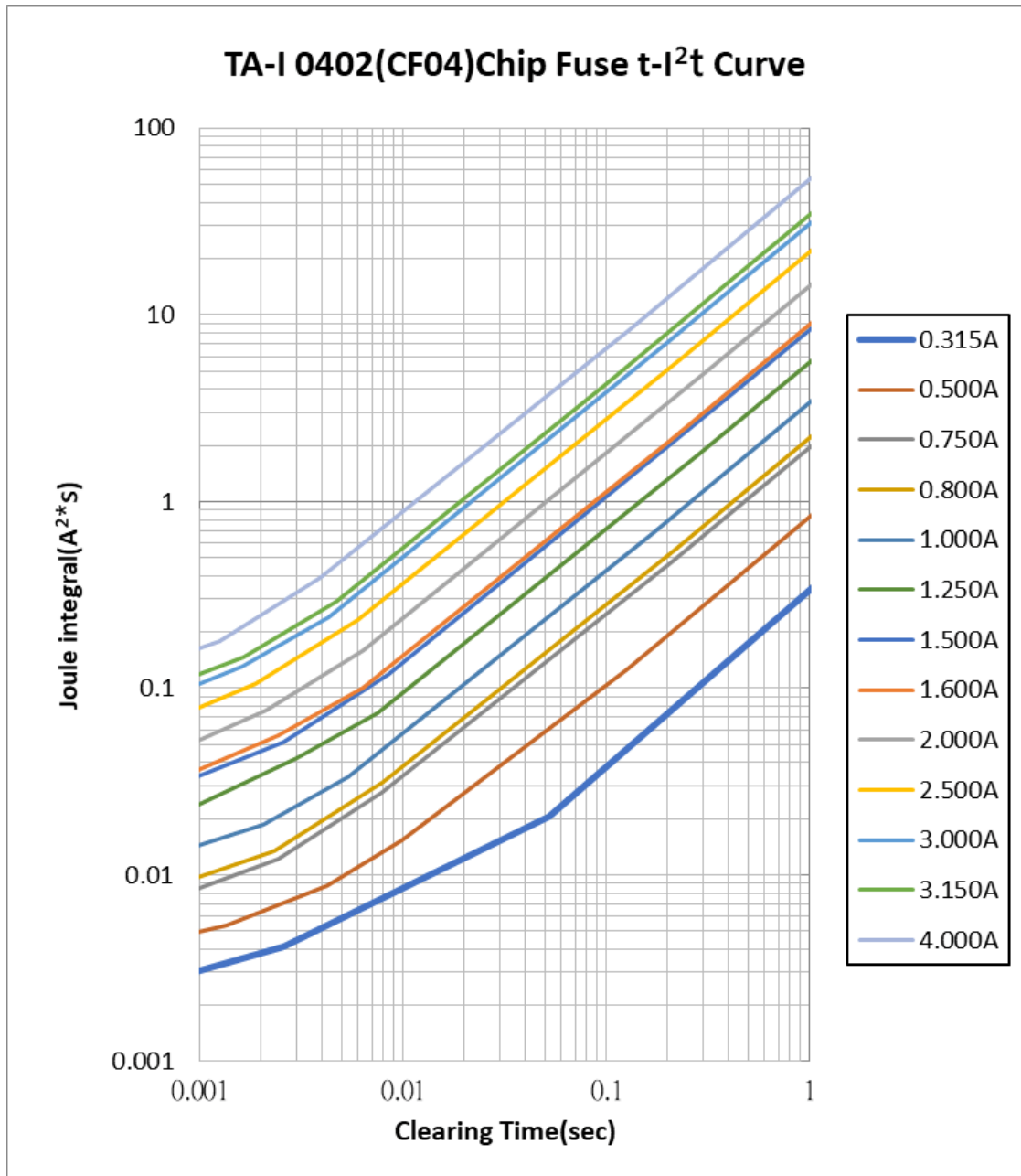



Thin Film Chip Fuse



| | |
|-------------|--------------|
| Document No | TCF-XX0S032N |
| Issued date | 2023/07/21 |
| Page | 16/19 |

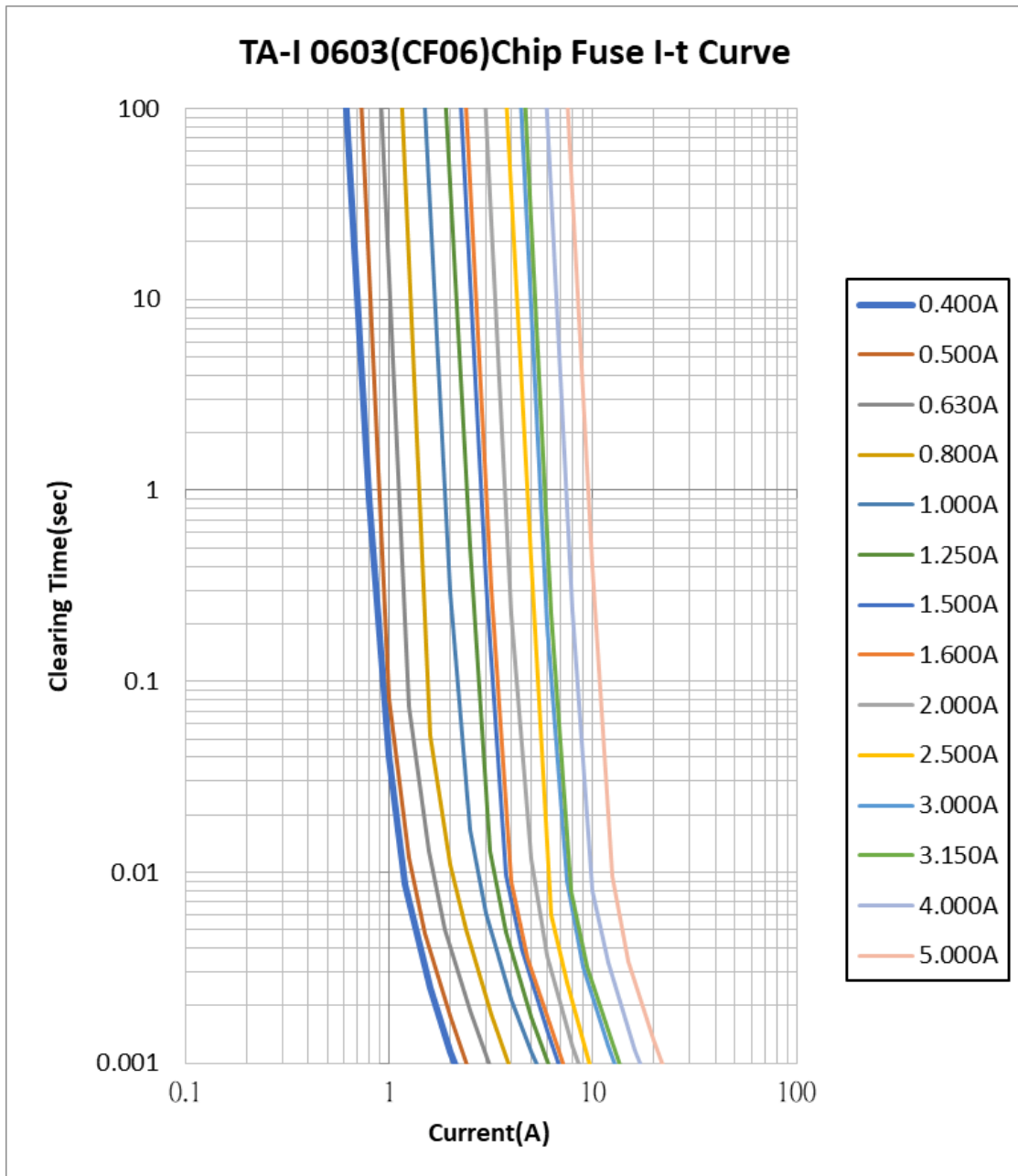



Thin Film Chip Fuse



| | |
|-------------|--------------|
| Document No | TCF-XX0S032N |
| Issued date | 2023/07/21 |
| Page | 17/19 |

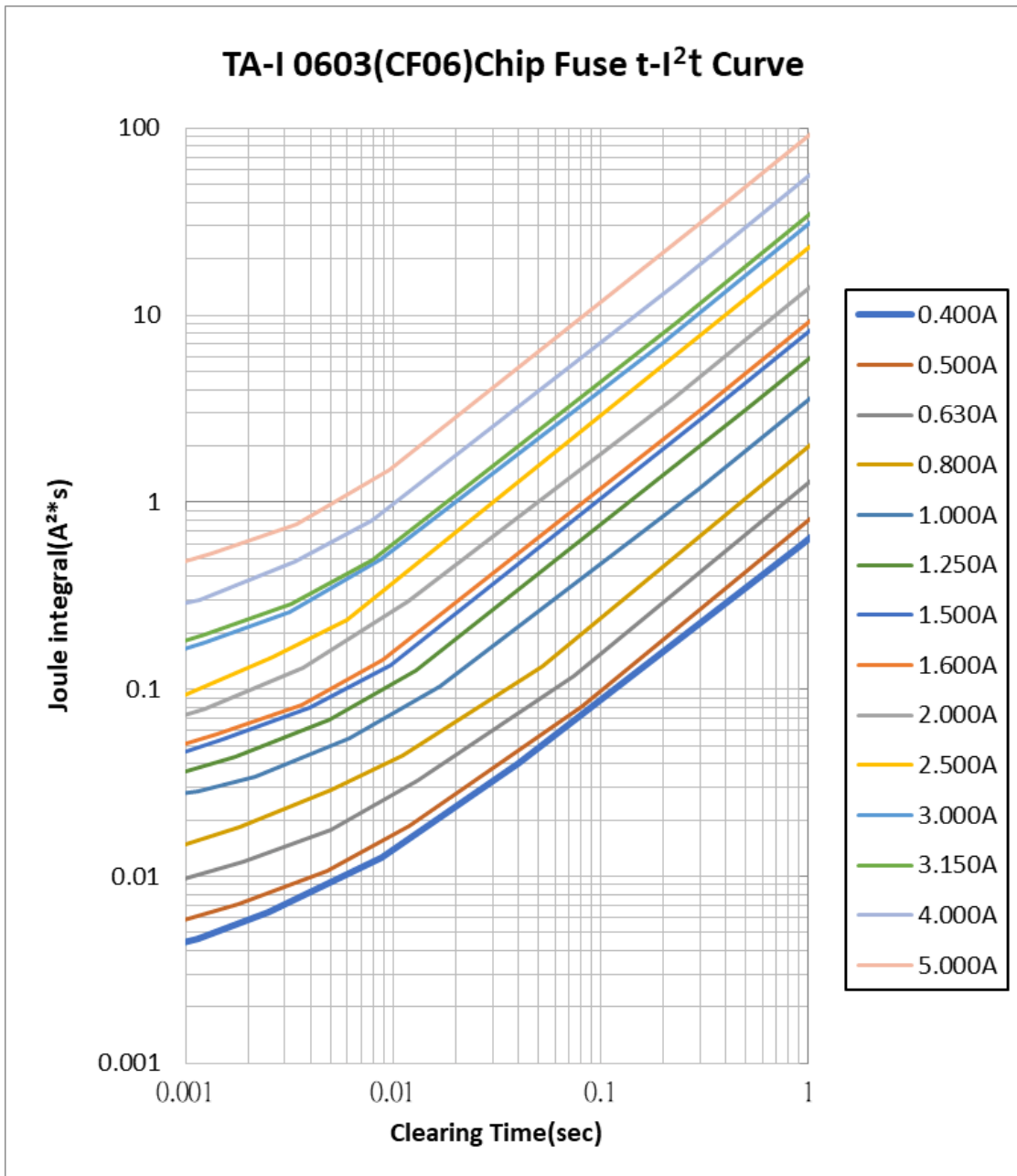



Thin Film Chip Fuse



| | |
|-------------|--------------|
| Document No | TCF-XX0S032N |
| Issued date | 2023/07/21 |
| Page | 18/19 |

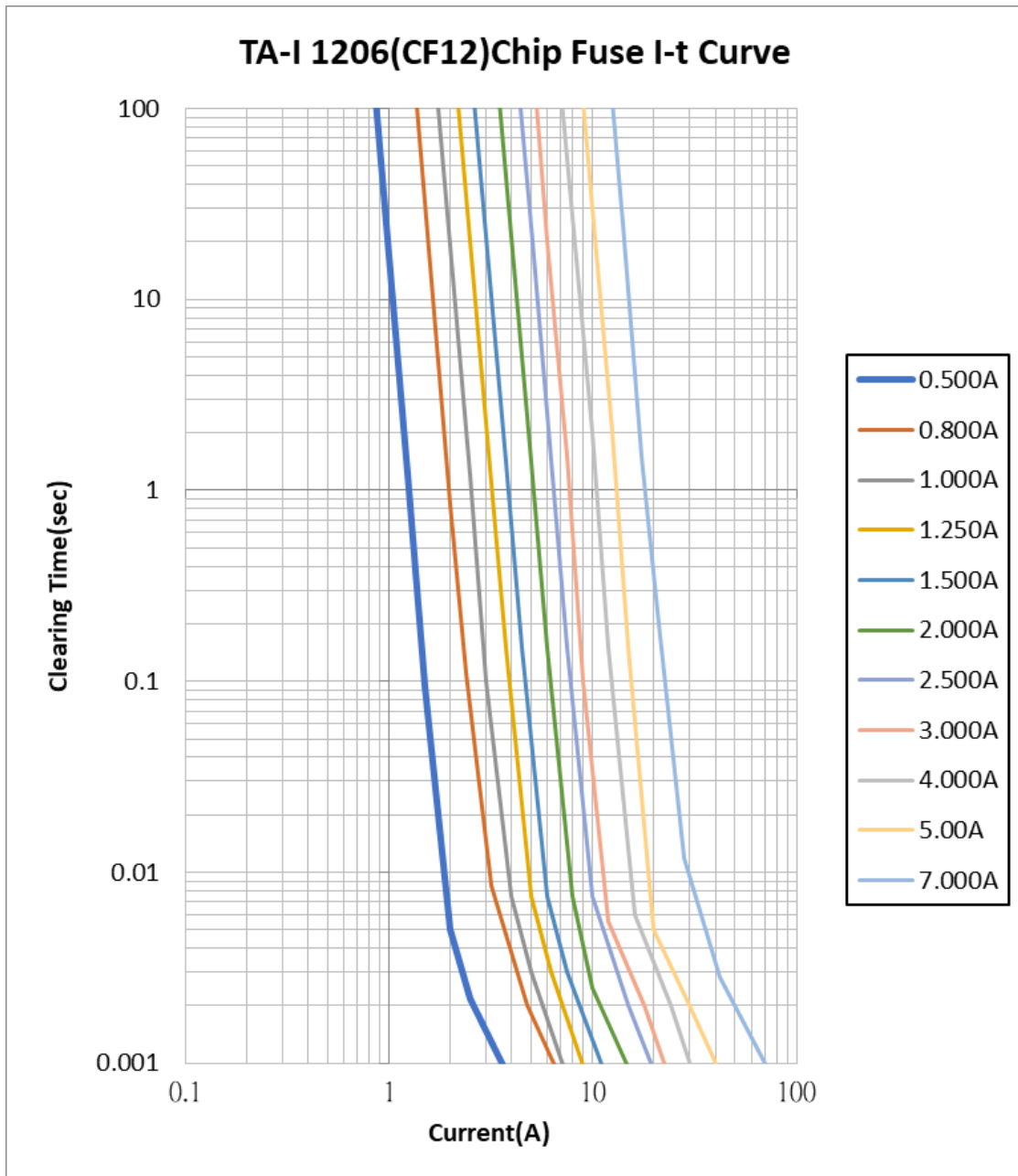



Thin Film Chip Fuse



| | |
|-------------|--------------|
| Document No | TCF-XX0S032N |
| Issued date | 2023/07/21 |
| Page | 19/19 |

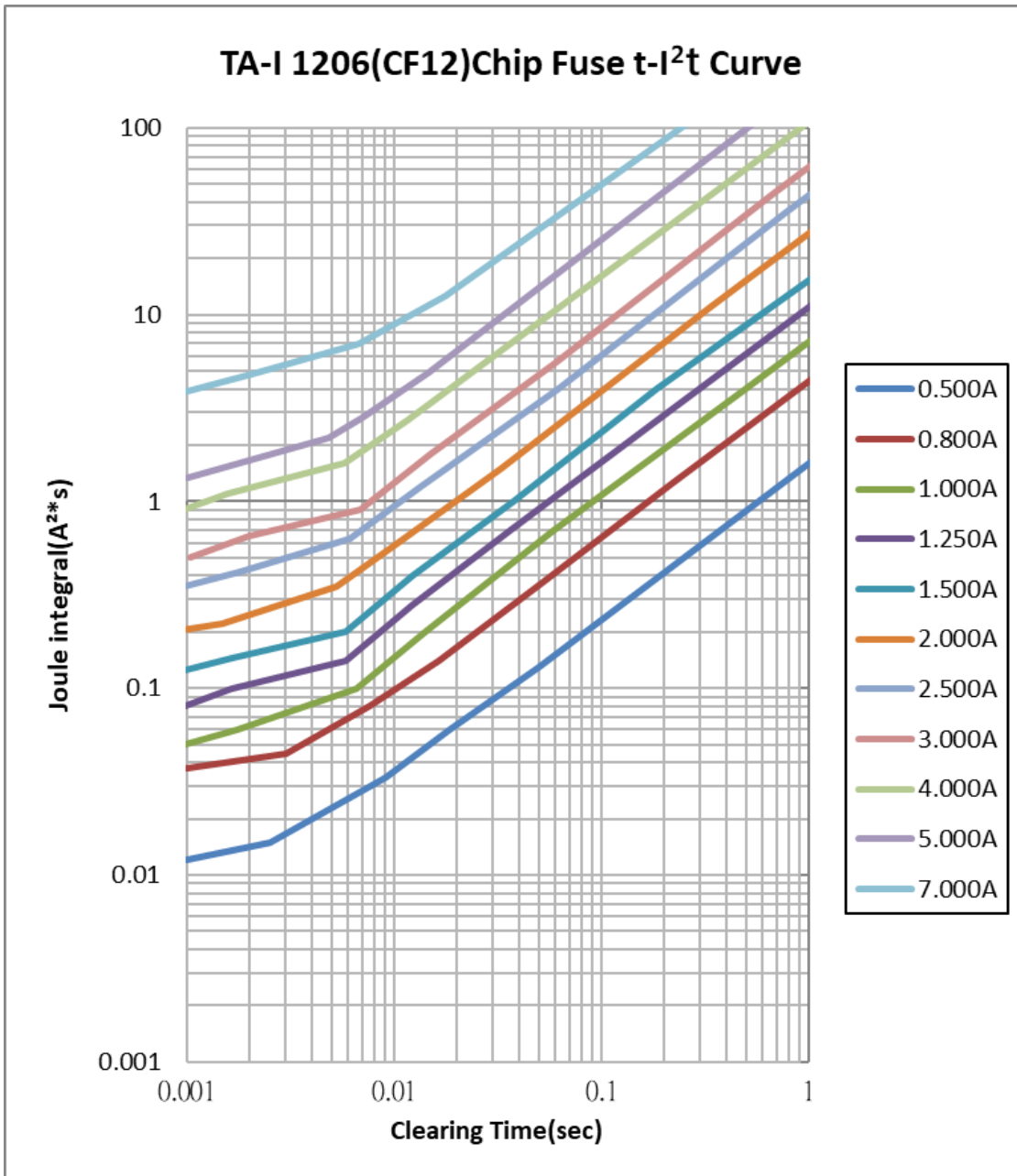

单击下面可查看定价，库存，交付和生命周期等信息

[>>TA-I\(大毅\)](#)