



Thin Film Chip Fuse

(AEC-Q200 tested/ )

| | |
|-------------|---------------|
| Document No | TCFS-XX0S004N |
| Issued date | 2023/05/15 |
| Page | 1/19 |

1. Scope

This specification applies for the fuse series of thin film chip fuse made by TA-I.

2. Construction

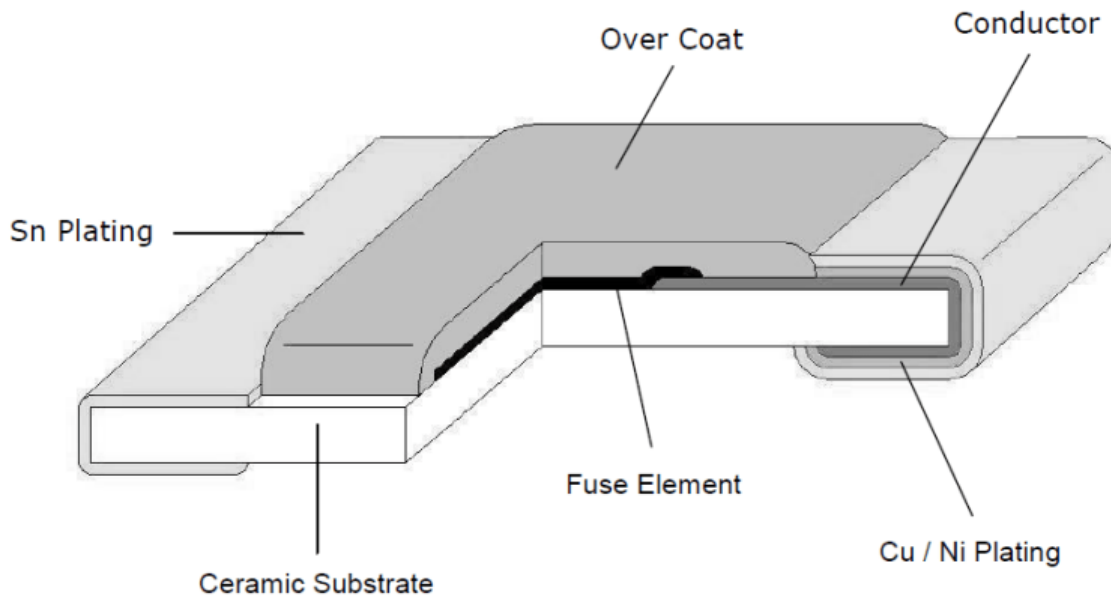

3. Type Designation

| CFS | 06 | V5 | T | R50 |
|-----------|---|----------------------------|---------------------------|--------------------|
| | Size | Rate Voltage | Packaging | Rate Current |
| Chip Fuse | 04:0402(1005) 06:0603(1608) 12:1206(3216) | V6:63V V5:50V V3:32V | T: Paper Tape (5K/10K) | R50:0.5A 1R0:1A |



Thin Film Chip Fuse

(AEC-Q200 tested/ **CS** **US**)

| | |
|-------------|---------------|
| Document No | TCFS-XX0S004N |
| Issued date | 2023/05/15 |
| Page | 2/19 |

4. Dimensions

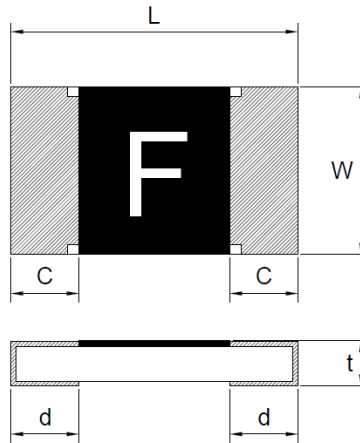

Unit: mm

| Type (Inch Size code) | Dimensions (mm) | | | | |
|--------------------------|-----------------|-----------|---------|----------|-----------|
| | L | W | C | d | t |
| CFS04 (0402) | 1.0±0.1 | 0.52±0.05 | 0.2±0.1 | 0.25±0.1 | 0.35±0.05 |
| CFS06 (0603) | 1.6±0.1 | 0.80±0.10 | 0.3±0.2 | 0.35±0.2 | 0.45±0.10 |
| CFS12 (1206) | 3.1±0.1 | 1.55±0.10 | 0.5±0.3 | 0.50±0.2 | 0.60±0.10 |

5. Applications and ratings

| Part Designation | Marking | Rated Current | Fusing Time | Resistance (mΩ) Tolerance±25% | Rated Voltage | Breaking Capacity | Body Temperature rising |
|------------------|---------|---------------|---|----------------------------------|---------------|-------------------|-----------------------------------|
| CFS04V3TR50 | F | 0.50A | Open within 5sec.at250% rated current | 300 | DC 32V | DC32V 35A | <75°C at 100% rated current |
| CFS04V3TR80 | K | 0.80A | | 78 | | | |
| CFS04V3T1R0 | L | 1.00A | | 75 | | | |
| CFS04V3T1R25 | M | 1.25A | | 44 | | | |
| CFS04V3T1R50 | P | 1.50A | | 34.5 | | | |
| CFS04V3T1R60 | N | 1.60A | | 29.5 | | | |
| CFS04V3T2R0 | S | 2.00A | | 23 | | | |
| CFS04V3T2R50 | T | 2.50A | | 18 | | | |
| CFS04V3T3R0 | 3 | 3.00A | | 15 | | | |
| CFS04V3T3R15 | U | 3.15A | | 14 | | | |
| CFS04V3T4R0 | W | 4.00A | 10 | | | | |

*Resistance value was measured with less than 10% of rated current



Thin Film Chip Fuse

(AEC-Q200 tested / **CS** **US**)

| | |
|-------------|---------------|
| Document No | TCFS-XX0S004N |
| Issued date | 2023/05/15 |
| Page | 3/19 |

| Part Designation | Marking | Rated Current | Fusing Time | Resistance (mΩ) Tolerance±25% | Rated Voltage | Breaking Capacity | Body Temperature rising |
|------------------|----------|---------------|---------------------------------------|----------------------------------|---------------|------------------------|-----------------------------|
| CFS06V5TR40 | <u>E</u> | 0.4A | Open within 5sec.at250% rated current | 350 | DC 50V | 50A DC50V/ AC35V | <75°C at 100% rated current |
| CFS06V5TR50 | F | 0.50A | | 232 | | | |
| CFS06V3TR63 | I | 0.63A | | 150 | DC 32V | 50A DC32V/ AC35V | |
| CFS06V3TR70 | J | 0.70A | | 148 | | | |
| CFS06V3TR80 | K | 0.80A | | 113 | | | |
| CFS06V3T1R0 | L | 1.00A | | 67 | | | |
| CFS06V3T1R25 | <u>M</u> | 1.25A | | 50 | | | |
| CFS06V3T1R50 | P | 1.50A | | 42 | | | |
| CFS06V3T1R60 | N | 1.60A | | 40 | | | |
| CFS06V3T2R0 | S | 2.00A | | 27 | | | |
| CFS06V3T2R50 | T | 2.50A | | 19.5 | | | |
| CFS06V3T3R00 | 3 | 3.00A | | 16 | | | |
| CFS06V3T3R15 | U | 3.15A | | 15 | | | |
| CFS06V3T4R0 | W | 4.00A | | 11 | | | |
| CFS06V3T5R0 | Y | 5.00A | | 8 | | | |
| CFS06V3T6R0 | <u>6</u> | 6.00A | | 6 | | | |

*Resistance valve was measured with less than 10% of rated current

| Part Designation | Marking | Rated Current | Fusing Time | Resistance (mΩ) Tolerance±25% | Rated Voltage | Breaking Capacity | Body Temperature rising |
|------------------|----------|---------------|---------------------------------------|----------------------------------|---------------|-------------------|-----------------------------|
| CFS12V6TR50 | F | 0.50A | Open within 5sec.at250% rated current | 596 | DC 63V | DC63V 50A | <75°C at 100% rated current |
| CFS12V6TR80 | K | 0.80A | | 165 | | | |
| CFS12V6T1R0 | L | 1.00A | | 132 | | | |
| CFS12V6T1R25 | <u>M</u> | 1.25A | | 90 | | | |
| CFS12V6T1R50 | P | 1.50A | | 79 | | | |
| CFS12V6T2R0 | S | 2.00A | | 41 | | | |
| CFS12V3T2R50 | T | 2.50A | | 33 | DC 32V | DC32V 50A | |
| CFS12V3T3R00 | 3 | 3.00A | | 23 | | | |
| CFS12V3T4R0 | W | 4.00A | | 15.5 | | | |
| CFS12V3T5R0 | Y | 5.00A | | 13 | | | |
| CFS12V3T7R0 | Z | 7.00A | | 7 | | | |

*Resistance valve was measured with less than 10% of rated current



Thin Film Chip Fuse

(AEC-Q200 tested/  US)

| | |
|-------------|---------------|
| Document No | TCFS-XX0S004N |
| Issued date | 2023/05/15 |
| Page | 4/19 |

6 Temperature Derating Curve

6.1 Normal Ambient Temperature: 25°C

6.2 Operating Temperature: -55°C ~150°C , with proper derating factor as below:

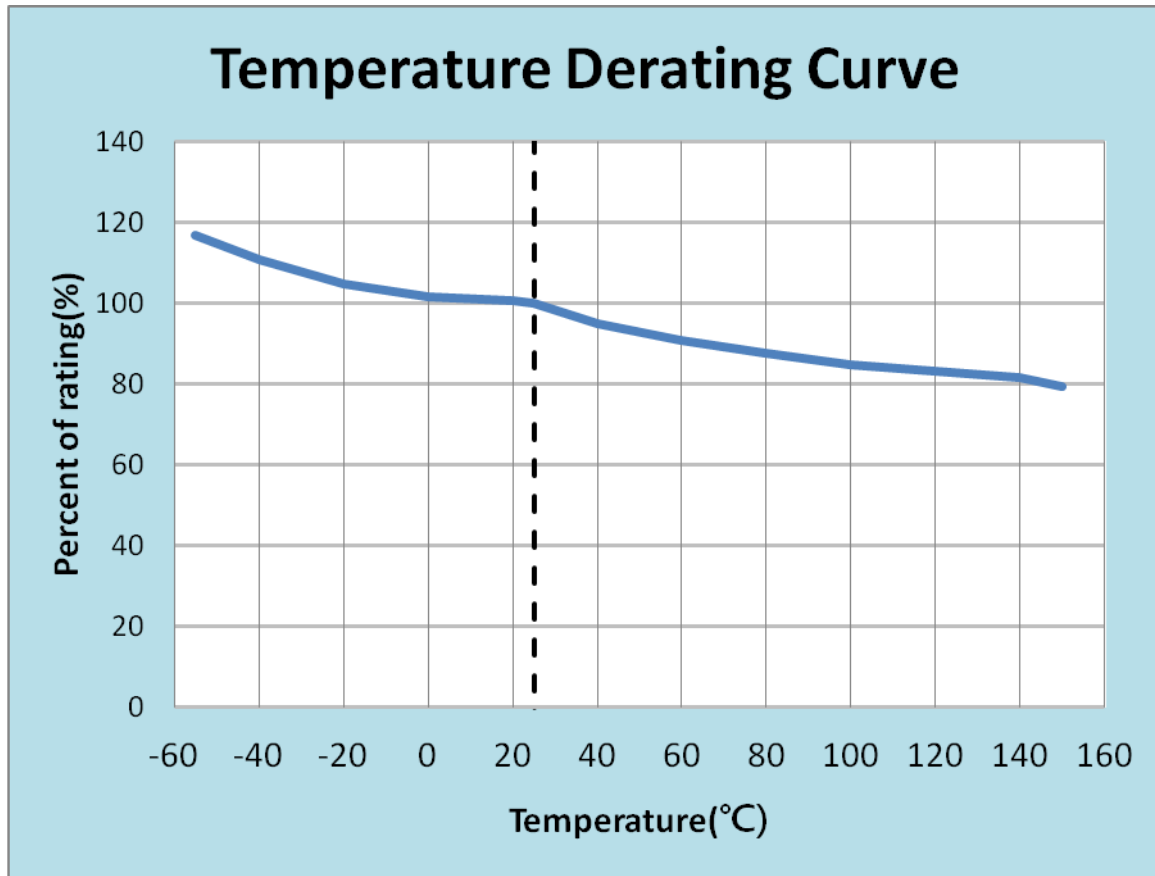



Thin Film Chip Fuse

(AEC-Q200 tested/ [®])

| | |
|-------------|---------------|
| Document No | TCFS-XX0S004N |
| Issued date | 2023/05/15 |
| Page | 5/19 |

7 Reliability Tests

| No. | Parameter | Test Method | Requirement |
|-----|---------------------------|---|--|
| #1 | Solderability | aging 4 hours at 150 °C dry heat Lead-free solder bath at 245±3 °C for 3±0.5 seconds. 260±3 °C for 7±0.5 seconds | 95% coverage minimum |
| #2 | Resistance to solder Heat | Immerse the specimens in and eutectic solder at 260+5/-0°C for 10±1S . | ±10% |
| #3 | Moisture Resistance | T=24 hours / Cycle ,10Cycles . Notes: Steps 7a& 7b not required. Unpowered . | ±10% |
| #4 | Thermal Shock | Temperature -55°C/+155°C. Number of cycles required:300 Maximum transfer time-20 seconds, Dwell time-15 minutes. Air-Air. | ±10% |
| #5 | Mechanical Shock | Wave Form: Tolerance for half sine shock pulse. Peak value is 100g's. Normal duration(D) is 6(ms) | ±10% |
| #6 | Vibration | 5 g's for 20 min., 12 cycles each of 3 orientations. (Note: Test from 10-2000 Hz.) | ±10% |
| #7 | Terminal Strength | Force of 1.8kg for 1206/0603 Force of 1.0kg for 0402 | ±10% |
| #8 | High Temperature Storage | with exemptions 1000 hrs. @ T=125°C. Unpowered. Measurement at 24±2 hours after test conclusion. | ±10% |
| #9 | Temperature Cycling | 1000 Cycles (-40°C to +125°C) 30min maximum dwell time at each temperature extreme. 1 min. Maximum transition time. Measurement at 24±4 hours after test conclusion. | ±10% |
| #10 | Bias Humidity | 1000 hours 85°C/85%RH. Note: Specified conditions: 10% of operating current. Measurement at 24±2 hours after test conclusion. | ±10% |
| #11 | Operational Life | 1000 hours TA=85°C at 70% rated current. Measurement at 24±2 hours after test conclusion | ±10% |
| #12 | Resistance to Solvent | a:Isopropyl Alcohol : Mineral Spirits= 1 : 3 b:Terpene Defluxer (Bioact EC-7R) c:Deionized water : Propylene Glycol : Monomethyl Ether : monoethanolamine = 42 : 1 : 1 | No evident damages on protective coating |
| #13 | Board Flex(Bending) | 3mm deflection | ±10% |
| #14 | Carrying capacity | Rated current ,4hr | ±10% |
| #15 | Fusing Time | 250% of its rated current | < 5 sec |
| #16 | Interrupting Ability | After the fuse is interrupted ,rated voltage applied for 30sec again | No mechanical damages |
| #17 | Temperature Rise | 100% of its rated current, Measure of surface temperature | Δ T<75°C |
| #18 | Residual Resistance | Measure DC resistance after fusing | 10kΩ and more |
| #19 | Low Temperature Storage | 1000 hrs. @ T=-55°C. Unpowered. Measurement at 24±2 hours after test conclusion. | ±10% |



Thin Film Chip Fuse

(AEC-Q200 tested/ **US**)

| | |
|-------------|---------------|
| Document No | TCFS-XX0S004N |
| Issued date | 2023/05/15 |
| Page | 6/19 |

8 Taping & Reel

8.1 Taping Dimensions

4mm pitch paper

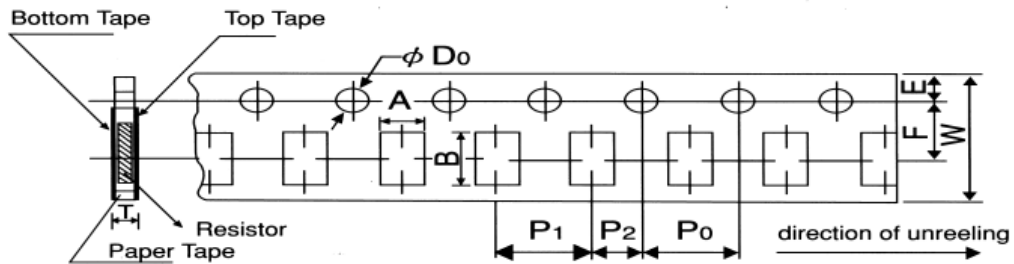

| Packing | Type | A | B | W | F | E | P_1 | P_2 | P_0 | D_0 | T |
|------------|-------|----------------|----------------|---------------|----------------|----------------|---------------|----------------|---------------|--|----------------|
| Paper Tape | CFS04 | 0.7 ± 0.05 | 1.2 ± 0.05 | 8.0 ± 0.2 | 3.5 ± 0.05 | 1.75 ± 0.1 | 2.0 ± 0.1 | 2.0 ± 0.05 | 4.0 ± 0.1 | $\phi \begin{matrix} +0.1 \\ 1.5 \\ 0 \end{matrix}$ | 0.45 ± 0.1 |
| Paper Tape | CFS06 | 1.1 ± 0.1 | 1.9 ± 0.1 | 8.0 ± 0.2 | 3.5 ± 0.05 | 1.75 ± 0.1 | 4.0 ± 0.1 | 2.0 ± 0.05 | 4.0 ± 0.1 | $\phi \begin{matrix} +0.1 \\ 1.5 \\ -0 \end{matrix}$ | 0.64 ± 0.1 |
| Paper Tape | CFS12 | 2.0 ± 0.15 | 3.6 ± 0.2 | 8.0 ± 0.2 | 3.5 ± 0.05 | 1.75 ± 0.1 | 4.0 ± 0.1 | 2.0 ± 0.05 | 4.0 ± 0.1 | $\phi \begin{matrix} +0.1 \\ 1.5 \\ -0 \end{matrix}$ | 0.84 ± 0.1 |

Unit: mm

| | | | |
|-----|----|------------|--|
| | | Paper Tape | |
| | | 2 mm pitch | |
| | | 180mm/R | |
| CFS | 04 | 10000 | |

| | | | |
|-----|----|------------|--|
| | | Paper Tape | |
| | | 4 mm pitch | |
| | | 180mm/R | |
| CFS | 06 | 5000 | |
| CFS | 12 | 5000 | |



Thin Film Chip Fuse

(AEC-Q200 tested/ )

| | |
|-------------|---------------|
| Document No | TCFS-XX0S004N |
| Issued date | 2023/05/15 |
| Page | 7/19 |

8.2 Reel Specifications

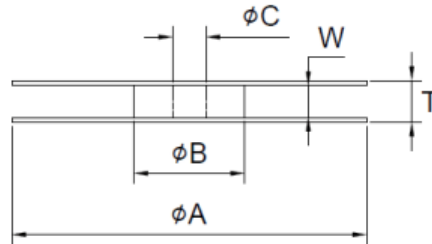

Unit: mm

| Series | ϕA | ϕB | ϕC | W | T |
|-------------------------|----------|----------|----------|---------|----------|
| CFS04 CFS06 CFS12 | 178 ±2.0 | 60.0±1.0 | 13.0±1.0 | 9.0±1.0 | 11.4±2.0 |

8.3 Peel –off force:

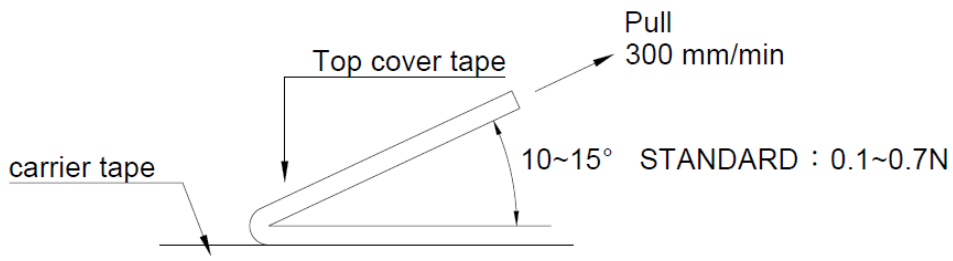

9 Storage Conditions:

Temperature: 5°C~35°C, Humidity:40%~75%

10 Shelf Life:

2 years from manufacturing date



Thin Film Chip Fuse

(AEC-Q200 tested/ **TAI**® US)

| | |
|-------------|---------------|
| Document No | TCFS-XX0S004N |
| Issued date | 2023/05/15 |
| Page | 8/19 |

11 Label



12 Recommended land patterns

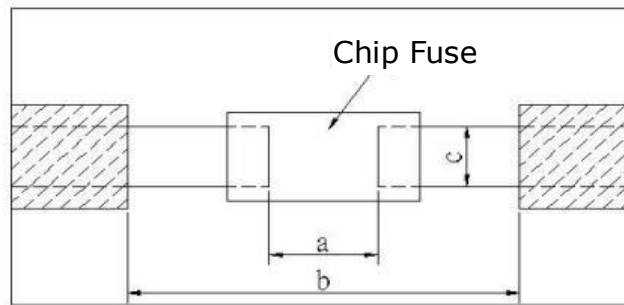

| Land pattern | | Dimension | | |
|--------------|-----------|-----------|-----------|-----------|
| Type | Size | a | b | c |
| CFS | 04 (0402) | 0.55~0.65 | 1.40~1.60 | 0.74~0.94 |
| CFS | 06 (0603) | 0.85~0.95 | 2.00~2.20 | 1.50~1.70 |
| CFS | 12 (1206) | 0.95~1.05 | 4.40~5.00 | 2.30~2.50 |



Thin Film Chip Fuse

(AEC-Q200 tested/  US)

| | |
|-------------|---------------|
| Document No | TCFS-XX0S004N |
| Issued date | 2023/05/15 |
| Page | 9/19 |

13. Recommend IR – Reflow profile: (solder: Sn96.5 / Ag3 / Cu0.5)

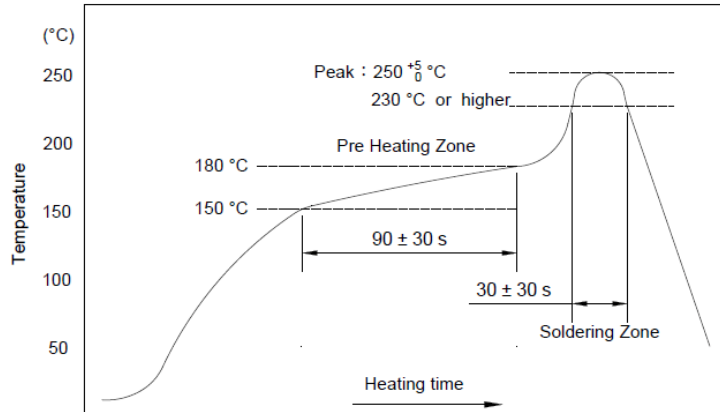

Peak : $250 \pm \frac{+5}{0} \text{ } ^\circ\text{C}$, 5 sec.

Pre-heat Zone : 150 to 180 °C , 90±30 sec

Soldering Zone : 230°C or higher , 30±10 sec

14. Approval by UL248-14

The fuses have been approved by UL.

File No. of UL Recognition is E241710

15. ECN

Engineering Change Notice: The customer will be informed with ECN if there is significant modification on the characteristics and materials described in Approval Sheet.

16. Manufacturing Country & City:

TA-I TECHNOLOGY CO., LTD. (Taiwan– Tao Yuan)

Tel: (+886) 3-3246169

Fax: (+886) 3-3246167

Associated companies:

(1) TA-I TECHNOLOGY (SU ZHOU) CO., LTD. (China – Su Zhou)

Tel: (+86) 512-63457879

Fax: (+86) 512-63457869

(2) TA-I TECHNOLOGY ELECTRONIC (DONGGUAN) CO., LTD. (China –Dongguan)

Tel: (+86) 769-8339-4790~3

Fax : (+86) 769-8339-4794

(3) FORTUNE TASK RESISTOR FACTORY (China – Dongguan)

Tel: (+86) 769-8339-4790~3

Fax : (+86) 769-8339-4794

(4) TAI OHM ELECTRONICS (M) SDN. BHD. (Malaysia – Penang)

Tel: (+60) 4- 3900480

Fax: (+60) 4-3901481

(5) P.T.TAI ELECTRONIC Indonesia (Indonesia – Jakarta)

Tel: (+62) 21-89830123

Fax: (+62) 21-89830703

TA-I TECHNOLOGY CO., LTD



Thin Film Chip Fuse

(AEC-Q200 tested/ US)

| | |
|-------------|---------------|
| Document No | TCFS-XX0S004N |
| Issued date | 2023/05/15 |
| Page | 10/19 |

17. Selection Guideline of Fuse:

■ Checklist of selection factors

- ⊙ Normal operating current
- ⊙ Normal operating voltage (AC or DC)
- ⊙ Ambient Temperature
- ⊙ Overload current and length of time in which the fuse must open .
- ⊙ Type of fuse (SMD or Tube) and physical size limitation (0603 or 1206)
- ⊙ Agency Approval required (e.g., UL248-14)

■ Normal operating current

e.g., Rectangular Wave, If $I_p = 1.5 A$, Normal operating current = 1.5 A

| No. | Type | Waveform | Formula |
|-----|------------------------|----------|--|
| 1 | Sinusoidal Waveform | | $\frac{1}{\sqrt{2}} I_m \cong 0.707 I_m$ |
| 2 | All Wave Rectification | | $\frac{1}{\sqrt{2}} I_m \cong 0.707 I_m$ |
| 3 | Half Wave | | $0.5 I_m$ |
| 4 | Triangle Waveform | | $\frac{1}{3} I_m \cong 0.577 I_m$ |
| 5 | Rectangular Waveform | | I_m |
| 6 | Trapezoidal Waveform | | $I_m \sqrt{1 - \frac{8\alpha}{3T}}$ |



Thin Film Chip Fuse

(AEC-Q200 tested / [®])

| | |
|-------------|---------------|
| Document No | TCFS-XX0S004N |
| Issued date | 2023/05/15 |
| Page | 11/19 |

| No. | Type | Waveform | Formula |
|-----|-------------------|----------|------------------------------|
| 7 | Rectangular Pulse | | $I_m \sqrt{\frac{\tau}{T}}$ |
| 8 | Triangle Pulse | | $I_m \sqrt{\frac{\tau}{3T}}$ |

■ Derating ratio for different ambient Temperature

- ⊙ Referring to bottom figure and select the appropriate derating ratio:
e.g., Ambient temperature is 60 degree C
the derating ratio ≈ 0.95

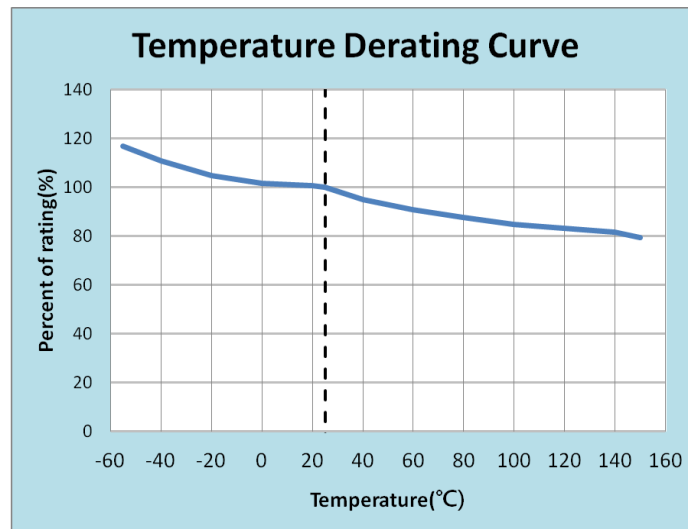

■ Calculating the required rating of fuse needed.

- ⊙ Safety coefficient: 70% is safety coefficient from practical experience
- ⊙ $\frac{\text{Normal Operating Current}}{0.7 \times \text{derating ratio}} < \text{rating current of fuse}$
- ⊙ e.g.
Condition: Normal operating current = 1.5 A
Ambient temperature 40 °C : Derating ratio ≈ 0.95



Thin Film Chip Fuse

(AEC-Q200 tested/ )

| | |
|-------------|---------------|
| Document No | TCFS-XX0S004N |
| Issued date | 2023/05/15 |
| Page | 12/19 |

$$\frac{1.5}{0.7 \times 0.95} < \text{rating current of fuse}$$

| |
|---|
| $2.255 < \text{rating current of fuse}$ |
|---|

■ Determination of the type of fuse

e.g.Condition:

- ◆ Calculating value =2.255 A , 2.255A < rating current of fuse
- ◆ Normal operating voltage : DC 12 V
- ◆ Following bottom index-table: suggesting use CFS06V3T2R50.

| Part Designation | Marking | Rated Current | Rated Voltage | Part Designation | Marking | Rated Current | Rated Voltage | Part Designation | Marking | Rated Current | Rated Voltage |
|------------------|----------|---------------|---------------|------------------|----------|---------------|---------------|------------------|----------|---------------|---------------|
| CFS04V3TR50 | F | 0.5A | 32V | CFS06V5TR40 | <u>E</u> | 0.40A | 50V | CFS12V6TR50 | F | 0.50A | 63V |
| CFS04V3TR80 | K | 0.80A | 32V | CFS06V5TR50 | F | 0.5A | 50V | CFS12V6TR80 | K | 0.80A | 63V |
| CFS04V3T1R0 | L | 1.00A | 32V | CFS06V3TR63 | I | 0.63A | 32V | CFS12V6T1R0 | L | 1.00A | 63V |
| CFS04V3T1R25 | <u>M</u> | 1.25A | 32V | CFS06V3TR70 | J | 0.7A | 32V | CFS12V6T1R25 | <u>M</u> | 1.25A | 63V |
| CFS04V3T1R50 | P | 1.50A | 32V | CFS06V3TR80 | K | 0.80A | 32V | CFS12V6T1R50 | P | 1.50A | 63V |
| CFS04V3T1R60 | N | 1.60A | 32V | CFS06V3T1R0 | L | 1.00A | 32V | CFS12V6T2R0 | S | 2.00A | 63V |
| CFS04V3T2R0 | S | 2.00A | 32V | CFS06V3T1R25 | <u>M</u> | 1.25A | 32V | CFS12V3T2R50 | T | 2.50A | 32V |
| CFS04V3T2R50 | T | 2.50A | 32V | CFS06V3T1R50 | P | 1.50A | 32V | CFS12V3T3R00 | 3 | 3.00A | 32V |
| CFS04V3T3R0 | 3 | 3.00A | 32V | CFS06V3T1R60 | N | 1.60A | 32V | CFS12V3T4R0 | W | 4.00A | 32V |
| CFS04V3T3R15 | U | 3.15A | 32V | CFS06V3T2R0 | S | 2.00A | 32V | CFS12V3T5R0 | Y | 5.00A | 32V |
| CFS04V3T4R0 | W | 4.00A | 32V | CFS06V3T2R50 | T | 2.50A | 32V | CFS12V3T7R0 | Z | 7.00A | 32V |
| | | | | CFS06V3T3R00 | 3 | 3.00A | 32V | | | | |
| | | | | CFS06V3T3R15 | U | 3.15A | 32V | | | | |
| | | | | CFS06V3T4R0 | W | 4.00A | 32V | | | | |
| | | | | CFS06V3T5R0 | Y | 5.00A | 32V | | | | |
| | | | | CFS06V3T6R0 | <u>G</u> | 6.00A | 32V | | | | |

■ Inrush current:

- ◆ Considering inrush waveform & calculate I^2t (A²s) value
- ◆ Choosing fuse's I^2t (A²s) value > calculate I^2t (A²s) value
- ◆ Considering Ratio of I^2t repeat numbers to blowing .
- ◆ Confirm with us.

e.g., choosing 0603 Fuse

Condition:



Thin Film Chip Fuse

(AEC-Q200 tested/)

| | |
|-------------|---------------|
| Document No | TCFS-XX0S004N |
| Issued date | 2023/05/15 |
| Page | 13/19 |

1. Rectangular Wave, $I_p = 4 \text{ A}$, $t = 1 \text{ ms}$, calculate $I_p^2 t = 4^2 \times 1 \times 10^{-3} = 0.016 \text{ (A}^2\text{s)}$
2. Choosing CFS06V3T1R25, $I^2 t = 0.057 \text{ (A}^2\text{s)}$ → Page 13 index-table
3. Inrush shock : 100,000 times (≈ 0.35) → inrush ratio
4. Choosing fuse's $I^2 t \text{ (A}^2\text{s)}$ value X Derating ratio (inrush 100000 times) > calculate $I^2 t \text{ (A}^2\text{s)}$ value
5. $0.057 \times 0.35 = 0.01995 \text{ (A}^2\text{s)} > 0.016$ → CFS06V3T1R25 is able to meet circuit's application

| TA-I FUSE $I^2 t \text{ (A}^2 \text{ s)}$ | | | | | |
|---|---|--------------|---|--------------|---|
| Part Number | Typical $I^2 t \text{ (A}^2 \text{ s)}^*$ | Part Number | Typical $I^2 t \text{ (A}^2 \text{ s)}^*$ | Part Number | Typical $I^2 t \text{ (A}^2 \text{ s)}^*$ |
| CFS04V3TR50 | 0.00370 | CFS06V5TR40 | 0.004 | CFS12V6TR50 | 0.030 |
| CFS04V3TR80 | 0.00947 | CFS06V5TR50 | 0.009 | CFS12V6TR80 | 0.068 |
| CFS04V3T1R0 | 0.01479 | CFS06V3TR63 | 0.017 | CFS12V6T1R0 | 0.098 |
| CFS04V3T1R25 | 0.02310 | CFS06V3TR70 | 0.023 | CFS12V6T1R25 | 0.155 |
| CFS04V3T1R50 | 0.02400 | CFS06V3TR80 | 0.024 | CFS12V6T1R50 | 0.236 |
| CFS04V3T1R60 | 0.03734 | CFS06V3T1R0 | 0.026 | CFS12V6T2R0 | 0.339 |
| CFS04V3T2R0 | 0.04040 | CFS06V3T1R25 | 0.057 | CFS12V3T2R50 | 0.605 |
| CFS04V3T2R50 | 0.06760 | CFS06V3T1R50 | 0.081 | CFS12V3T3R00 | 0.933 |
| CFS04V3T3R0 | 0.09860 | CFS06V3T1R60 | 0.086 | CFS12V3T4R0 | 1.537 |
| CFS04V3T3R15 | 0.10868 | CFS06V3T2R0 | 0.115 | CFS12V3T5R0 | 2.533 |
| CFS04V3T4R0 | 0.11450 | CFS06V3T2R50 | 0.200 | CFS12V3T7R0 | 5.684 |
| | | CFS06V3T3R00 | 0.210 | | |
| | | CFS06V3T3R15 | 0.279 | | |
| | | CFS06V3T4R0 | 0.326 | | |
| | | CFS06V3T5R0 | 0.622 | | |
| | | CFS06V3T6R0 | 2.700 | | |

Note*: Typical $I^2 t$ value is measured at 10x-rated current, application with surge over 10x-rated current.

Please confirm with us.

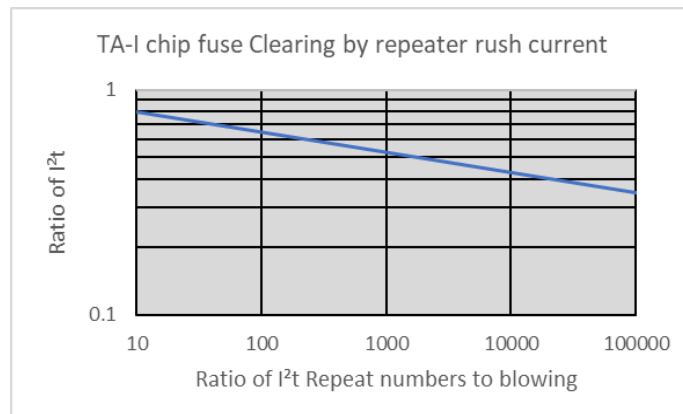



Thin Film Chip Fuse

(AEC-Q200 tested/ **TAI**® US)

| | |
|-------------|---------------|
| Document No | TCFS-XX0S004N |
| Issued date | 2023/05/15 |
| Page | 14/19 |

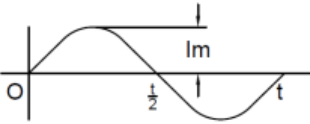
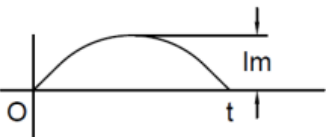
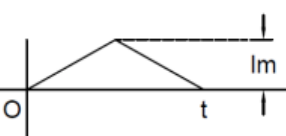
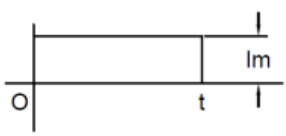
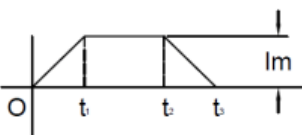
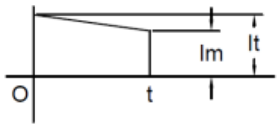
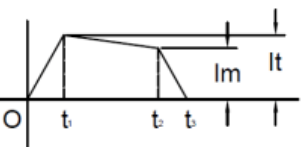
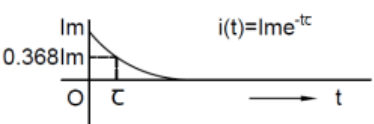
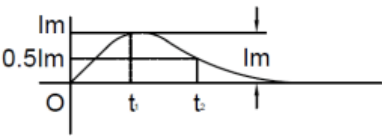
| No. | Type | Waveform | Formula |
|-----|--|--|--|
| 1 | Sinusoidal Waveform (1 Cycle) |  | $\frac{1}{2} I_m^2 t$ |
| 2 | Sinusoidal Waveform (1/2 Cycle) |  | $\frac{1}{2} I_m^2 t$ |
| 3 | Triangle Waveform |  | $\frac{1}{3} I_m^2 t$ |
| 4 | Rectangular Waveform |  | $I_m^2 t$ |
| 5 | Trapezoidal Waveform |  | $\frac{1}{3} I_m^2 t + I_m^2 (t_1 - t_2) + \frac{1}{3} I_m^2 (t_2 - t_3)$ |
| 6 | Various Waveform 1 |  | $I_1 I_2 t + \frac{1}{3} (I_1 - I_2)^2 t$ |
| 7 | Various Waveform 2 |  | $I_1 I_2 t + \left[I_1 I_2 t + \frac{(I_1 - I_2)^2}{3} \right] * (t_2 - t_1) + \frac{1}{3} (I_2)^2 (t_3 - t_2)$ |
| 8 | Charge/Discharge Waveform |  | $\frac{1}{2} (I_m^2 \tau)$ |
| 9 | Lightning Surge Waveform |  | $I_m^2 \left[\frac{t_1}{3} + 0.721(t_2 - t_1) \right]$ |



Thin Film Chip Fuse

(AEC-Q200 tested/ )

| | |
|-------------|---------------|
| Document No | TCFS-XX0S004N |
| Issued date | 2023/05/15 |
| Page | 15/19 |

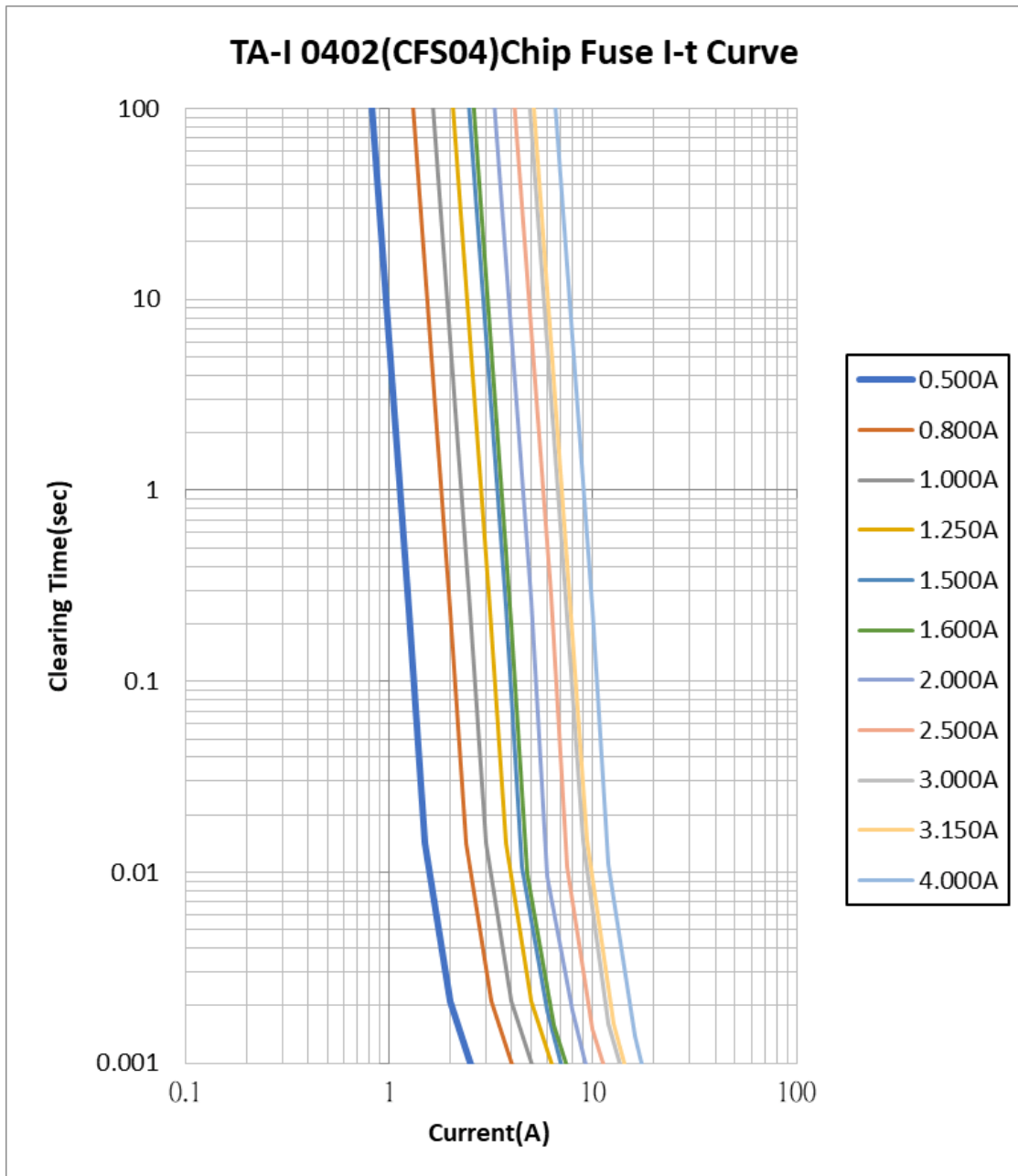



Thin Film Chip Fuse

(AEC-Q200 tested /  US)

| | |
|-------------|---------------|
| Document No | TCFS-XX0S004N |
| Issued date | 2023/05/15 |
| Page | 16/19 |

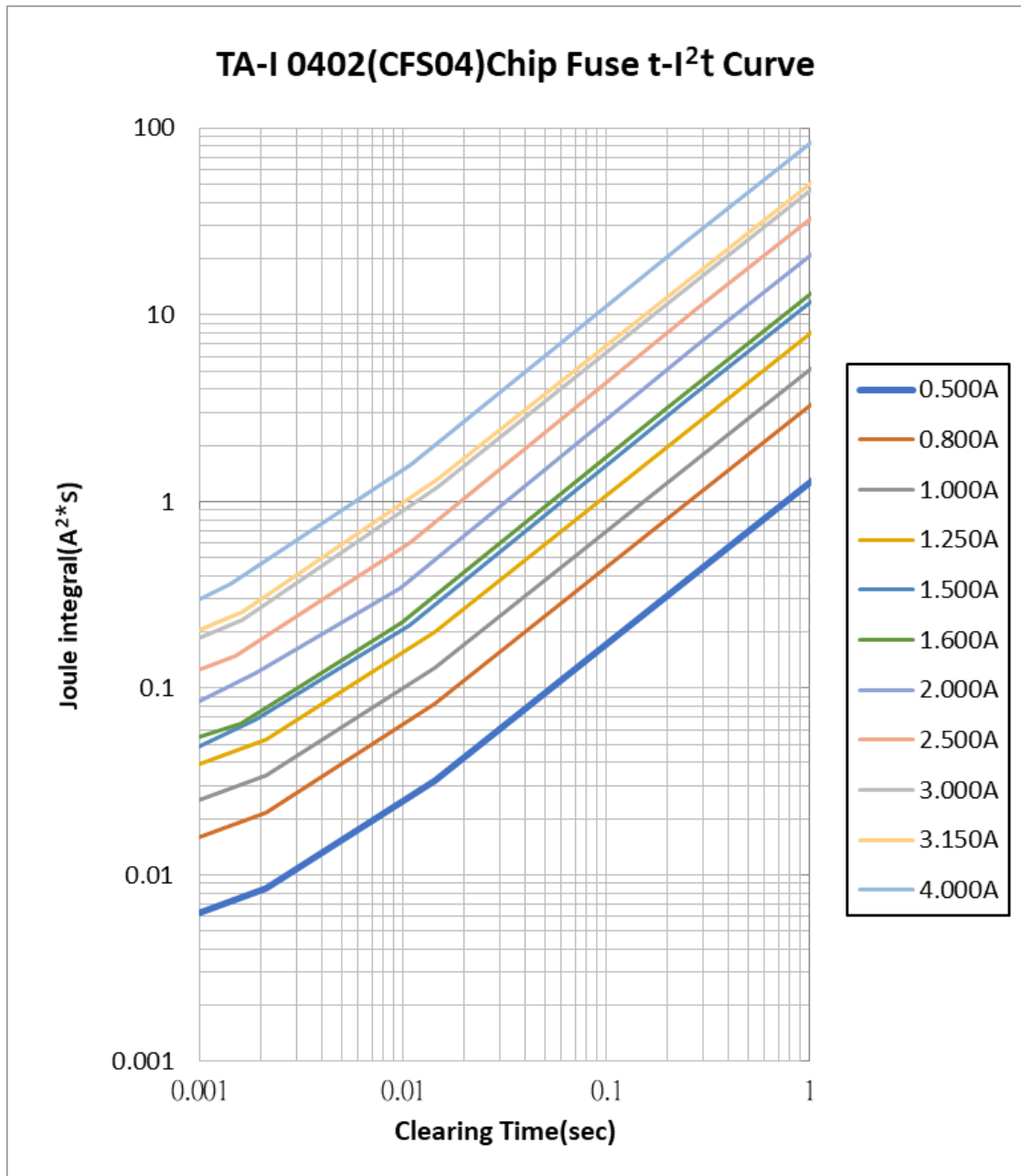



Thin Film Chip Fuse

(AEC-Q200 tested/  US)

| | |
|-------------|---------------|
| Document No | TCFS-XX0S004N |
| Issued date | 2023/05/15 |
| Page | 17/19 |

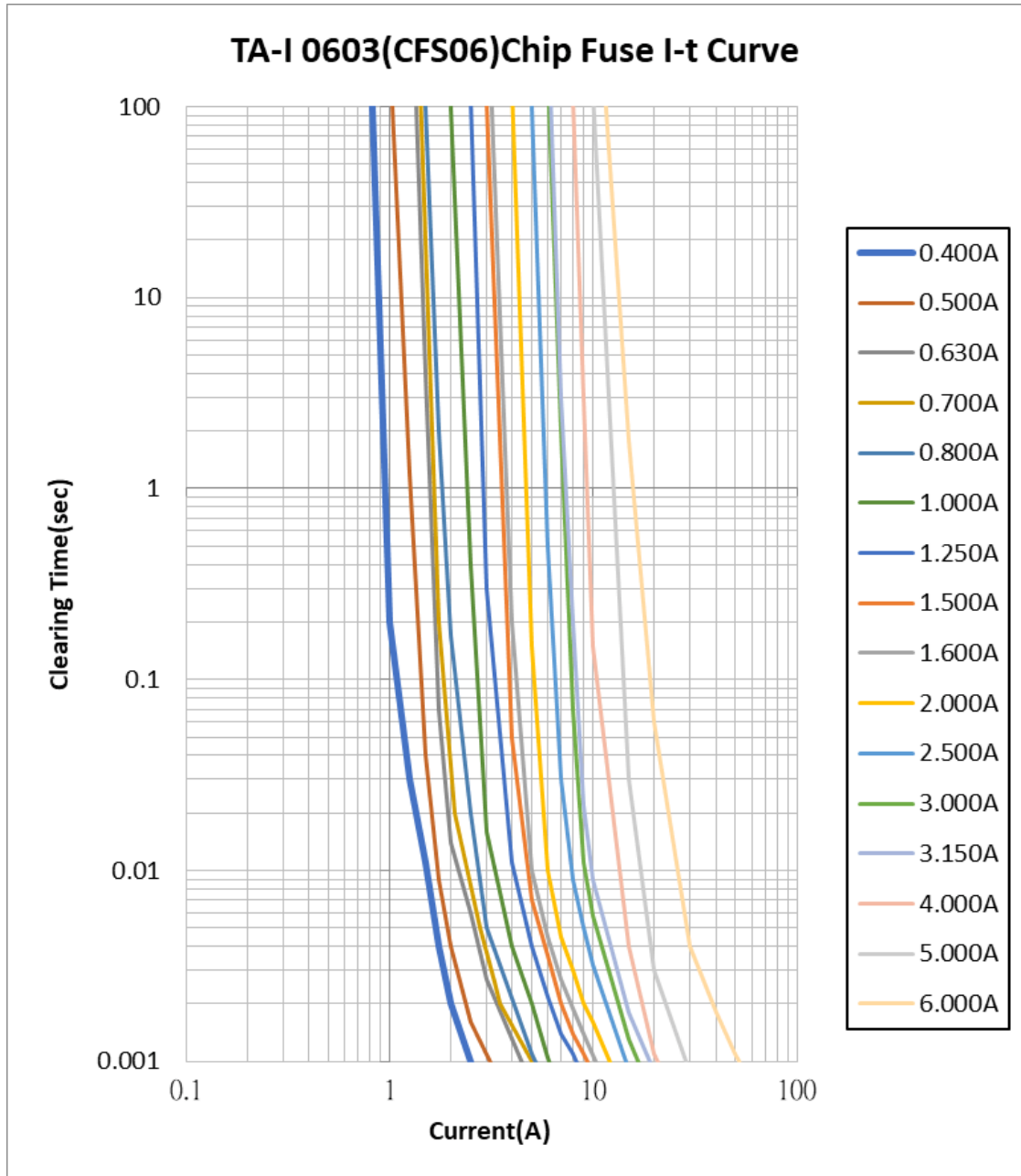



Thin Film Chip Fuse

(AEC-Q200 tested/  US)

| | |
|-------------|---------------|
| Document No | TCFS-XX0S004N |
| Issued date | 2023/05/15 |
| Page | 18/19 |

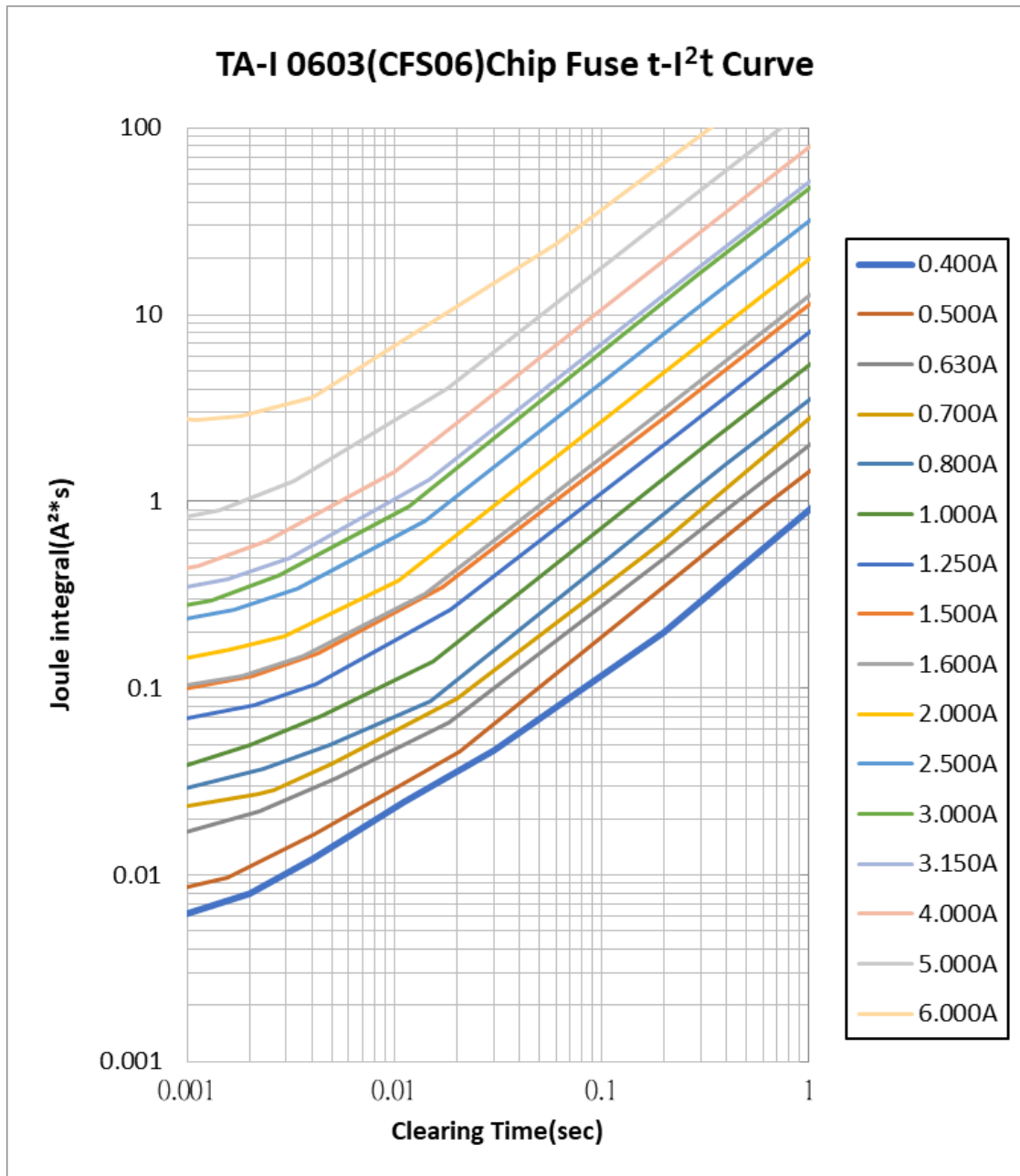



Thin Film Chip Fuse

(AEC-Q200 tested/  US)

| | |
|-------------|---------------|
| Document No | TCFS-XX0S004N |
| Issued date | 2023/05/15 |
| Page | 19/19 |

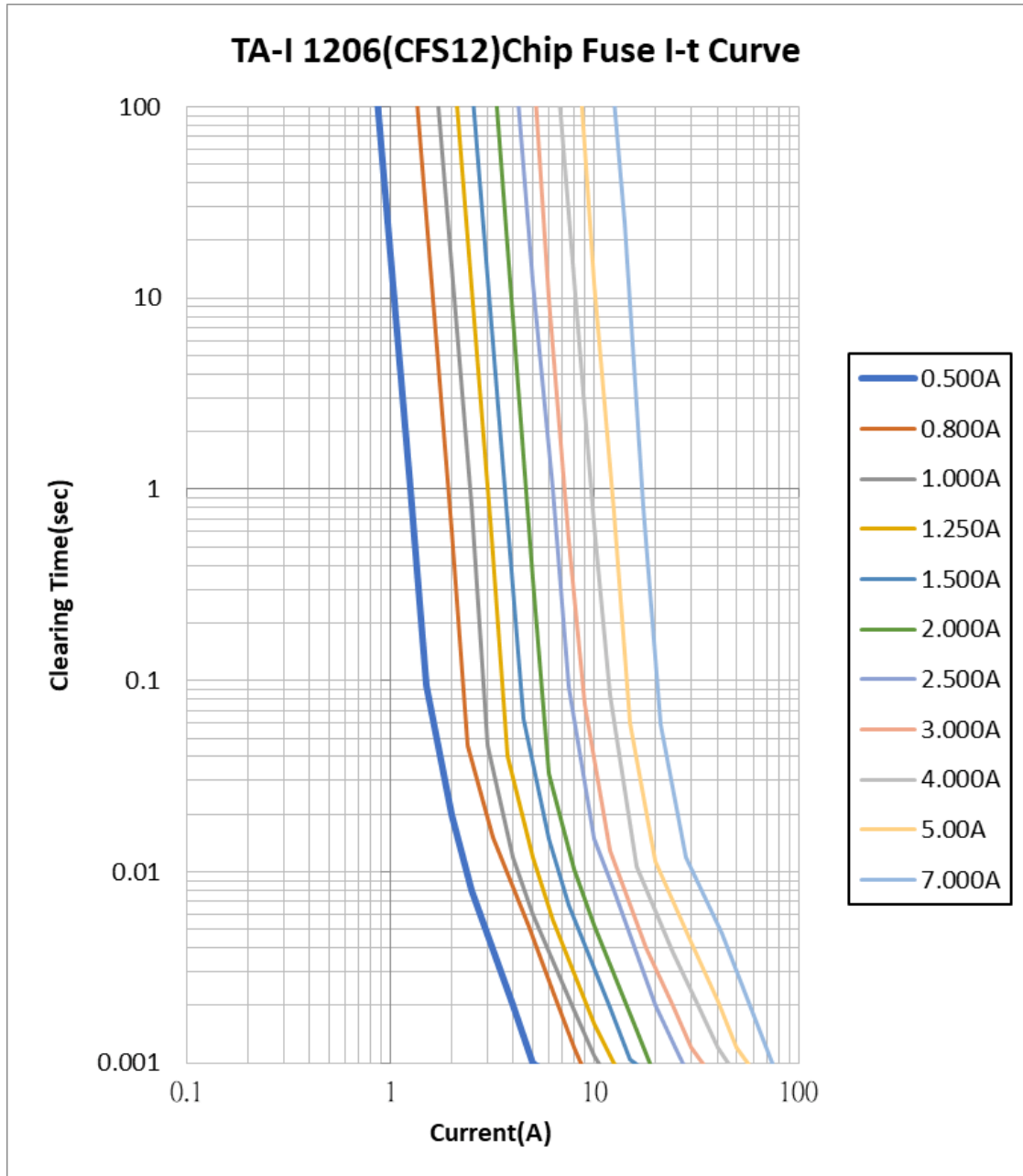



Thin Film Chip Fuse

(AEC-Q200 tested/  US)

| | |
|-------------|---------------|
| Document No | TCFS-XX0S004N |
| Issued date | 2023/05/15 |
| Page | 20/19 |

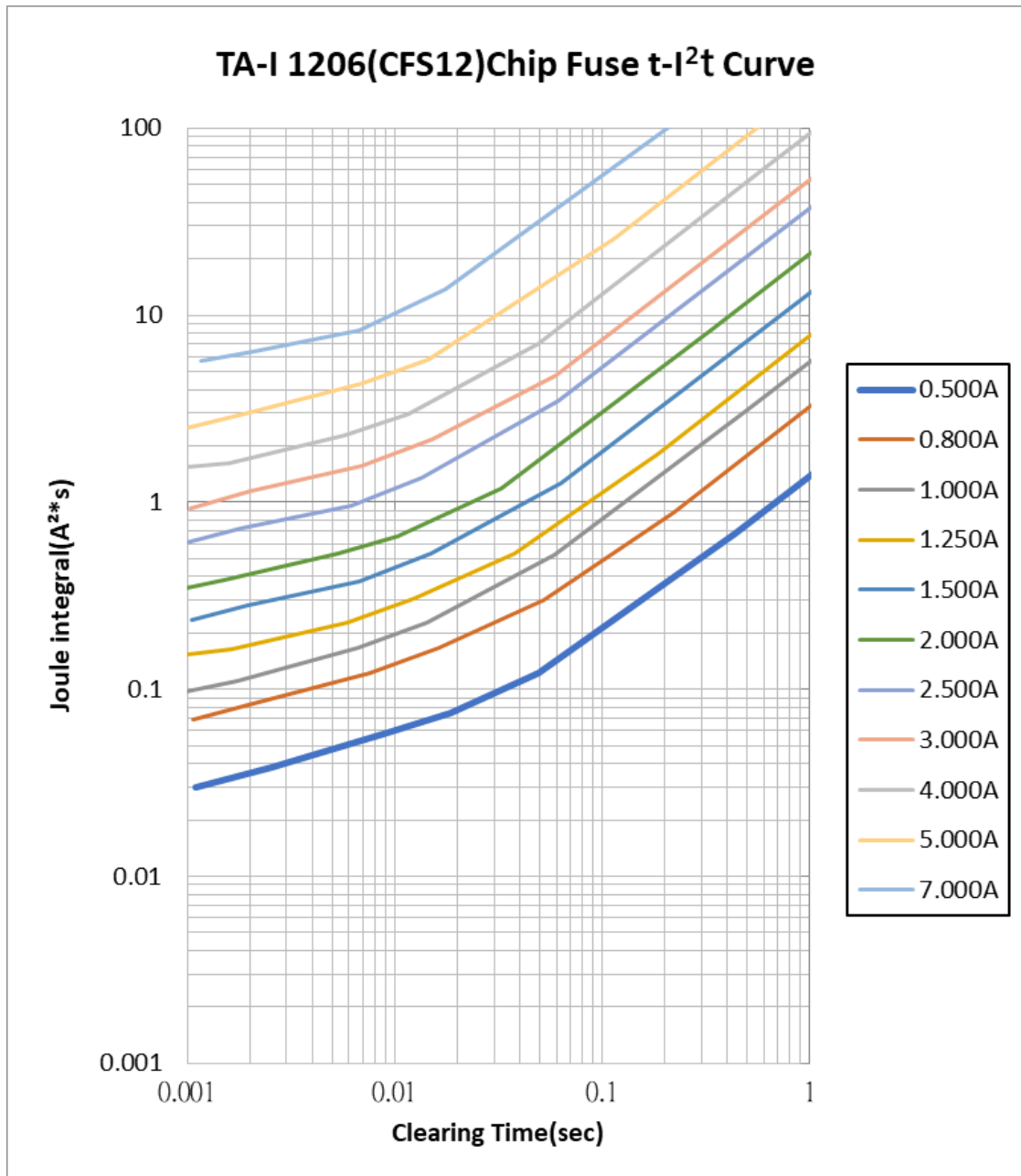

单击下面可查看定价，库存，交付和生命周期等信息

[>>TA-I\(大毅\)](#)