

BPSC Series

Features

- RoHS, Halogen Free and REACH Compliance
- Magnetic shielded
- Various package size and wide inductance range

Applications

- AP Routers
- STBs
- LCD TVs and monitors
- Game consoles
- LED lightings
- DC/DC converters

Product Identification

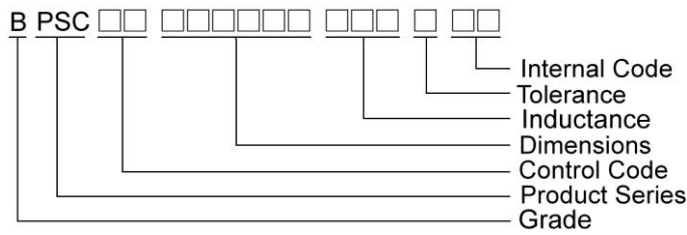

Shape and Dimensions

BPSC030316/030320

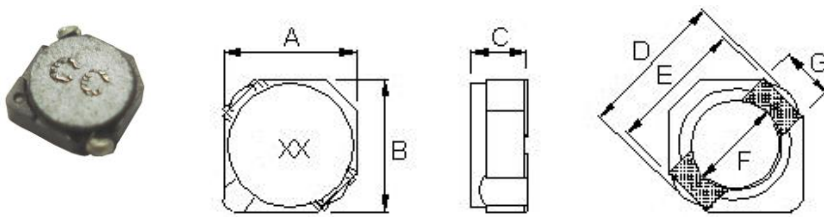

Recommended Pattern

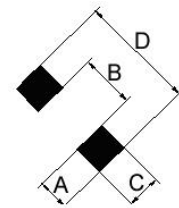

Dimension in mm

| TYPE | Shape and Dimensions | | | | | | | Recommended Pattern | | | |
|---------------|----------------------|-------------------|--------------------|-------------------|-----|-----|-----|---------------------|-----|-----|-----|
| | A | B | C | D | E | F | G | A | B | C | D |
| BPSC00030316 | 3.2 ⁺⁰ | 3.2 ⁺⁰ | 1.55 ⁺⁰ | 4.5 ⁺⁰ | 3.3 | 2.1 | 1.0 | 1.3 | 1.7 | 1.3 | 4.3 |
| BPSC000303020 | 3.2 ⁺⁰ | 3.2 ⁺⁰ | 2.0 ⁺⁰ | 4.5 ⁺⁰ | 3.3 | 2.1 | 1.0 | 1.3 | 1.7 | 1.3 | 4.3 |

Shape and Dimensions

BPSC00040412

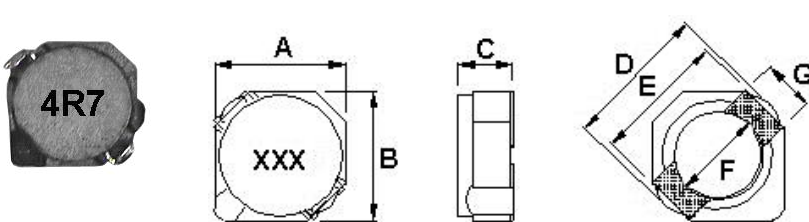

Recommended Pattern

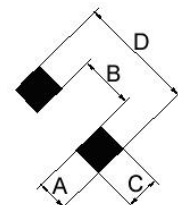

Dimension in mm

| TYPE | Shape and Dimensions | | | | | | | Recommended Pattern | | | |
|--------------|----------------------|-----------------|-------------------|-------------------|-----|-----|-----|---------------------|-----|-----|-----|
| | A | B | C | D | E | F | G | A | B | C | D |
| BPSC00040412 | 4 ⁺⁰ | 4 ⁺⁰ | 1.2 ⁺⁰ | 5.2 ⁺⁰ | 4.4 | 2.8 | 1.1 | 1.4 | 2.4 | 1.5 | 5.2 |

SMD Shielded Power Inductors - BPSC Series

Shape and Dimensions

BPSC00040418

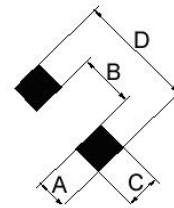
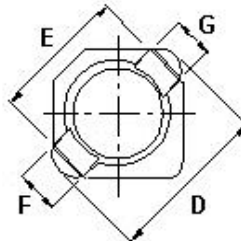
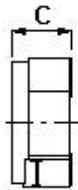
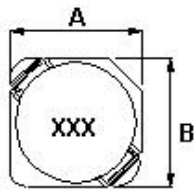

Dimensions in mm

| TYPE | Shape and Dimensions | | | | | | | Recommended Pattern | | | |
|--------------|----------------------|-----------------|-------------------|-------------------|--------|-------------------|--------|---------------------|-----|-----|-----|
| | A | B | C | D | E | F | G | A | B | C | D |
| BPSC00040418 | 4 ⁺⁰ | 4 ⁺⁰ | 1.8 ⁺⁰ | 5.2 ⁺⁰ | 4.4Typ | 1.4 ⁺⁰ | 1.1Typ | 1.4 | 2.4 | 1.5 | 5.2 |

Shape and Dimensions

BPSC00404030

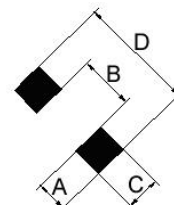
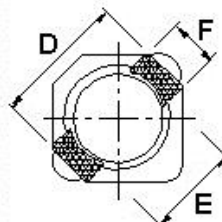
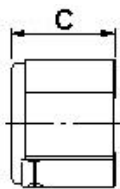
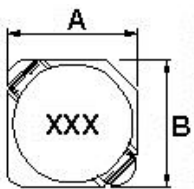

Dimension in mm

| TYPE | Shape and Dimensions | | | | | | Recommended Pattern | | | |
|--------------|----------------------|-----------------|-----------------|-----|-----|-----|---------------------|-----|-----|-----|
| | A | B | C | D | E | F | A | B | C | D |
| BPSC00404030 | 4 ⁺⁰ | 4 ⁺⁰ | 3 ⁺⁰ | 4.4 | 2.8 | 1.1 | 1.4 | 2.4 | 1.5 | 5.2 |

SMD Shielded Power Inductors - BPSC Series

Electrical Characteristics

| Part Number | Inductance (μ H) | Tolerance (\pm %) | Test Frequency | RDC (Ω)Max | Isat(A) Max(Typ.) | Irms (A)Typ. | Marking |
|--------------------|--------------------------|-------------------------|-------------------|------------------------|----------------------|-----------------|---------|
| BPSC00030316R47□00 | 0.47 | 30 | 100 kHz, 1 V | 0.04 | 2.00(2.80) | | AO |
| BPSC000303161R5□00 | 1.5 | 30 | 100 kHz, 1 V | 0.063 | 1.40(1.80) | 2 | BF |
| BPSC000303161R8□00 | 1.8 | 30 | 100 kHz, 1 V | 0.075 | 1.30(1.70) | 1.8 | BI |
| BPSC000303162R2□00 | 2.2 | 30 | 100 kHz, 1 V | 0.094 | 1.20(1.60) | 1.6 | CC |
| BPSC000303162R7□00 | 2.7 | 30 | 100 kHz, 1 V | 0.106 | 1.10(1.40) | 1.4 | CH |
| BPSC000303163R3□00 | 3.3 | 30 | 100 kHz, 1 V | 0.125 | 0.95(1.20) | 1.24 | DD |
| BPSC000303163R9□00 | 3.9 | 30 | 100 kHz, 1 V | 0.138 | 0.92(1.10) | 1.12 | DJ |
| BPSC000303164R1□00 | 4.1 | 20,30 | 100 kHz, 1 V | 0.169 | 0.80(1.00) | 1 | EA |
| BPSC000303164R7□00 | 4.7 | 20,30 | 100 kHz, 1 V | 0.169 | 0.80(1.00) | 1 | EH |
| BPSC000303165R6□00 | 5.6 | 20,30 | 100 kHz, 1 V | 0.188 | 0.76(0.95) | 0.98 | FG |
| BPSC000303166R8□00 | 6.8 | 20,30 | 100 kHz, 1 V | 0.213 | 0.71(0.88) | 0.92 | GI |
| BPSC000303168R2□00 | 8.2 | 20,30 | 100 kHz, 1 V | 0.281 | 0.64(0.80) | 0.8 | IC |
| BPSC00030316100□00 | 10 | 20,30 | 100 kHz, 1 V | 0.294 | 0.57(0.72) | 0.76 | KA |
| BPSC00030316120□00 | 12 | 20,30 | 100 kHz, 1 V | 0.394 | 0.52(0.65) | 0.64 | QA |

Note: When ordering, please specify tolerance code. Tolerance: M= \pm 20% , T= \pm 30%

- Operating temperature range - 30°C ~ 100°C(Including self - temperature rise)
- Isat for Inductance drop 35% from its value with current
- I rms for a 40°C temperature rise from 25°C ambient.
- RDC test method: place testing device to the 2 solder ends of winding and test the value.
- Measure Equipment :
 - L : Agilent/ E4980 or HP4284A
 - RDC : Chroma 16502
 - Isat : HP4284+42841A or WK3260B+WK3265B
 - I rms : HP4284+42841A or WK3260B+WK3265B

SMD Shielded Power Inductors - BPSC Series

Electrical Characteristics

| Part Number | Inductance (μ H) | Tolerance (\pm %) | Test Frequency | RDC (Ω)Max | Isat(A) Max(Typ.) | Irms (A)Typ. | Marking |
|--------------------|--------------------------|-------------------------|-------------------|------------------------|----------------------|-----------------|---------|
| BPSC000303202R2□LD | 2.2 | 20,30 | 100 kHz, 1V | 0.041 | 0.85(1.10) | 2.3 | CC |
| BPSC000303203R3□LD | 3.3 | 20,30 | 100 kHz, 1V | 0.054 | 0.75(0.95) | 2.1 | DD |
| BPSC000303204R7□LD | 4.7 | 20,30 | 100 kHz, 1V | 0.078 | 0.63(0.78) | 1.65 | EH |
| BPSC000303206R8□LD | 6.8 | 20,30 | 100 kHz, 1V | 0.106 | 0.52(0.65) | 1.32 | GI |
| BPSC00030320100□LD | 10 | 20,30 | 100 kHz, 1V | 0.18 | 0.43(0.53) | 1 | KA |
| BPSC00030320150□LD | 15 | 20,30 | 100 kHz, 1V | 0.22 | 0.35(0.45) | 0.8 | MA |
| BPSC00030320220□LD | 22 | 20,30 | 100 kHz, 1V | 0.32 | 0.30(0.36) | 0.68 | LA |
| BPSC00030320330□LD | 33 | 20,30 | 100 kHz, 1V | 0.46 | 0.24(0.31) | 0.56 | NA |
| BPSC00030320390□LD | 39 | 20,30 | 100 kHz, 1V | 0.6 | 0.21(0.28) | | PA |
| BPSC00030320470□LD | 47 | 20,30 | 100 kHz, 1V | 0.66 | 0.19(0.24) | 0.48 | OA |

Note: When ordering, please specify tolerance code. Tolerance: M=±20% , T=±30%

- Operating temperature range - 30°C ~ 100°C(Including self - temperature rise)
- Isat for Inductance drop 35% from its value with current
- Irms for a 40°C temperature rise from 25°C ambient.
- RDC test method: place testing device to the 2 solder ends of winding and test the value.
- Measure Equipment :
L : Agilent/ E4980 or HP4284A
RDC : Chroma 16502
Isat : HP4284+42841A or WK3260B+WK3265B
Irms : HP4284+42841A or WK3260B+WK3265B

SMD Shielded Power Inductors - BPSC Series

Electrical Characteristics

| Part Number | Inductance (μ H) | Tolerance (\pm %) | Test Frequency | RDC (Ω)Max | Isat(A) Max(Typ.) | Irms (A)Typ. | Marking |
|--------------------|--------------------------|-------------------------|-------------------|------------------------|----------------------|-----------------|---------|
| BPSC000303201R5□HP | 1.5 | 30 | 100kHz,1V | 0.05 | 1.90(2.40) | 2.2 | BF |
| BPSC000303201R7□HP | 1.7 | 20,30 | 100kHz,1V | 0.05 | 1.85(2.40) | 2.2 | BH |
| BPSC000303202R2□HP | 2.2 | 20,30 | 100kHz,1V | 0.06 | 1.60(2.30) | 1.9 | CC |
| BPSC000303203R3□HP | 3.3 | 20,30 | 100kHz,1V | 0.097 | 1.45(1.80) | 1.55 | DD |
| BPSC000303204R7□HP | 4.7 | 20,30 | 100kHz,1V | 0.14 | 1.00(1.50) | 1.2 | EH |
| BPSC000303206R3□HP | 6.3 | 20,30 | 100kHz,1V | 0.18 | 0.96(1.30) | 1.15 | GD |
| BPSC000303206R8□HP | 6.8 | 20,30 | 100kHz,1V | 0.195 | 0.95(1.20) | 1.1 | GI |
| BPSC00030320100□HP | 10 | 20,30 | 100kHz,1V | 0.285 | 0.85(1.00) | 0.9 | KA |
| BPSC00030320150□HP | 15 | 20,30 | 100kHz,1V | 0.41 | 0.67(0.83) | 0.64 | MA |
| BPSC00030320220□HP | 22 | 20,30 | 100kHz,1V | 0.65 | 0.50(0.67) | 0.6 | LA |

Note: When ordering, please specify tolerance code. Tolerance: M= \pm 20% , T= \pm 30%

- Operating temperature range - 30°C ~ 100°C(Including self - temperature rise)
- Isat for Inductance drop 35% from its value with current
- Irms for a 40°C temperature rise from 25°C ambient.
- RDC test method: place testing device to the 2 solder ends of winding and test the value.
- Measure Equipment :
 L : Agilent/ E4980 or HP4284A
 RDC : Chroma 16502
 Isat : HP4284+42841A or WK3260B+WK3265B
 Irms : HP4284+42841A or WK3260B+WK3265B

SMD Shielded Power Inductors - BPSC Series

Electrical Characteristics

| Part Number | Inductance (μ H) | Tolerance (\pm %) | Test Frequency | RDC (Ω)Max | Rated Current (A) | Irms (A)Typ. | Marking |
|--------------------|--------------------------|-------------------------|-------------------|------------------------|-------------------------|-----------------|---------|
| BPSC000404122R7□00 | 2.7 | 30 | 100 kHz, 1 V | 0.078 | 0.53 | 1.82 | 2R7 |
| BPSC000404124R7□00 | 4.7 | 20,30 | 100 kHz, 1 V | 0.123 | 0.4 | 1.38 | 4R7 |
| BPSC000404126R8□00 | 6.8 | 30 | 100 kHz, 1 V | 0.18 | 0.34 | 1.05 | 6R8 |
| BPSC000404128R2□00 | 8.2 | 30 | 100 kHz, 1 V | 0.204 | 0.32 | 0.93 | 8R2 |
| BPSC00040412100□00 | 10 | 20,30 | 100 kHz, 1 V | 0.24 | 0.28 | 0.9 | 100 |
| BPSC00040412120□00 | 12 | 20,30 | 100 kHz, 1 V | 0.276 | 0.25 | 0.81 | 120 |
| BPSC00040412150□00 | 15 | 20,30 | 100 kHz, 1 V | 0.372 | 0.23 | 0.68 | 150 |
| BPSC00040412180□00 | 18 | 20,30 | 100 kHz, 1 V | 0.468 | 0.21 | 0.58 | 180 |
| BPSC00040412220□00 | 22 | 20,30 | 100 kHz, 1 V | 0.54 | 0.19 | 0.53 | 220 |
| BPSC00040412270□00 | 27 | 20,30 | 100 kHz, 1 V | 0.726 | 0.17 | 0.48 | 270 |
| BPSC00040412330□00 | 33 | 20,30 | 100 kHz, 1 V | 0.822 | 0.15 | 0.41 | 330 |
| BPSC00040412390□00 | 39 | 20,30 | 100 kHz, 1 V | 0.942 | 0.14 | 0.4 | 390 |

Note: When ordering, please specify tolerance code. Tolerance: M= \pm 20% , T= \pm 30%

- Operating temperature range - 30°C ~ 100°C(Including self - temperature rise)
- Rated current for Inductance drop 35% from its value with current
- I rms for a 40°C temperature rise from 25°C ambient.
- RDC test method: place testing device to the 2 solder ends of winding and test the value.
- Measure Equipment :
 - L : Agilent/ E4980 or HP4284A
 - RDC : Chroma 16502
 - Rated current : HP4284+42841A or WK3260B+WK3265B
 - I rms : HP4284+42841A or WK3260B+WK3265B

SMD Shielded Power Inductors - BPSC Series

Electrical Characteristics

| Part Number | Inductance (μ H) | Tolerance (\pm %) | Test Frequency | RDC (Ω)Max | Rated Current (A) | Irms (A)Typ. | Marking |
|--------------------|--------------------------|-------------------------|-------------------|------------------------|-------------------------|-----------------|---------|
| BPSC00040412R60□HP | 0.6 | 30 | 100 kHz, 1 V | 0.059 | 2.9 | 1.8 | R60 |
| BPSC000404121R2□HP | 1.2 | 30 | 100 kHz, 1 V | 0.082 | 2 | 1.7 | 1R2 |
| BPSC000404121R5□HP | 1.5 | 30 | 100 kHz, 1 V | 0.104 | 1.85 | 1.45 | 1R5 |
| BPSC000404122R2□HP | 2.2 | 30 | 100 kHz, 1 V | 0.143 | 1.6 | 1.15 | 2R2 |
| BPSC000404123R3□HP | 3.3 | 30 | 100 kHz, 1 V | 0.182 | 1.25 | 0.95 | 3R3 |
| BPSC000404124R7□HP | 4.7 | 30 | 100 kHz, 1 V | 0.2 | 1.2 | 0.9 | 4R7 |
| BPSC000404126R8□HP | 6.8 | 30 | 100 kHz, 1 V | 0.377 | 0.85 | 0.7 | 6R8 |
| BPSC00040412100□HP | 10 | 20,30 | 100 kHz, 1 V | 0.413 | 0.8 | 0.6 | 100 |
| BPSC00040412120□HP | 12 | 20,30 | 100 kHz, 1 V | 0.585 | 0.64 | 0.48 | 120 |
| BPSC00040412150□HP | 15 | 20,30 | 100 kHz, 1 V | 0.653 | 0.58 | 0.45 | 150 |
| BPSC00040412180□HP | 18 | 20,30 | 100 kHz, 1 V | 0.888 | 0.52 | 0.4 | 180 |
| BPSC00040412220□HP | 22 | 20,30 | 100 kHz, 1 V | 0.925 | 0.53 | 0.33 | 220 |

Note: When ordering, please specify tolerance code. Tolerance: M= \pm 20% , T= \pm 30%

- Operating temperature range - 30°C ~ 100°C(Including self - temperature rise)
- Rated current for Inductance drop 35% from its value with current
- I rms for a 40°C temperature rise from 25°C ambient.
- RDC test method: place testing device to the 2 solder ends of winding and test the value.
- Measure Equipment :
 L : Agilent/ E4980 or HP4284A
 RDC : Chroma 16502
 Rated current : HP4284+42841A or WK3260B+WK3265B
 I rms : HP4284+42841A or WK3260B+WK3265B

SMD Shielded Power Inductors - BPSC Series

Electrical Characteristics

| Part Number | Inductance (μ H) | Tolerance (\pm %) | Test Frequency | RDC (Ω)Max | Rated Current (A) | Marking |
|--------------------|--------------------------|-------------------------|-------------------|------------------------|-------------------------|---------|
| BPSC000404181R0□S1 | 1.0 | 30 | 100kHz,0.1V | 0.04 | 1.6 | 1R0 |
| BPSC000404181R5□S1 | 1.5 | 30 | 100kHz,0.1V | 0.052 | 1.55 | 1R5 |
| BPSC000404182R2□S1 | 2.2 | 30 | 100kHz,0.1V | 0.072 | 1.2 | 2R2 |
| BPSC000404183R3□S1 | 3.3 | 30 | 100kHz,0.1V | 0.085 | 1.1 | 3R3 |
| BPSC000404184R7□S1 | 4.7 | 20,30 | 100kHz,0.1V | 0.105 | 0.9 | 4R7 |
| BPSC000404185R6□S1 | 5.6 | 30 | 100kHz,0.1V | 0.135 | 0.8 | 5R6 |
| BPSC000404186R8□S1 | 6.8 | 20,30 | 100kHz,0.1V | 0.17 | 0.73 | 6R8 |
| BPSC000404188R2□S1 | 8.2 | 20,30 | 100kHz,0.1V | 0.21 | 0.55 | 8R2 |
| BPSC00040418100□S1 | 10 | 20,30 | 100kHz,0.1V | 0.21 | 0.55 | 100 |
| BPSC00040418150□S1 | 15 | 30 | 100kHz,0.1V | 0.295 | 0.45 | 150 |
| BPSC00040418220□S1 | 22 | 20,30 | 100kHz,0.1V | 0.43 | 0.4 | 220 |
| BPSC00040418330□S1 | 33 | 30 | 100kHz,0.1V | 0.675 | 0.32 | 330 |
| BPSC00040418101□S1 | 100 | 30 | 100kHz,0.1V | 2.75 | 0.13 | 101 |

Note: When ordering, please specify tolerance code. Tolerance: M= \pm 20% , T= \pm 30%

- Operating temperature range - 30°C ~ 100°C(Including self - temperature rise)
- Rated current : DC current that will cause L drop approximately 35% over its nominal value or DC current cause the temperature rising approximately 40°C ,whichever is lower.
- RDC test method: place testing device to the 2 solder ends of winding and test the value.
- Measure Equipment :
L : Agilent/ E4980 or HP4284A
RDC : Chroma 16502
Rated current : HP4284+42841A or WK3260B+WK3265B

SMD Shielded Power Inductors - BPSC Series

Electrical Characteristics

| Part Number | Inductance (μ H) | Tolerance (\pm %) | Test Frequency | RDC (Ω)Max | Rated Current (A) | Irms (A)Typ. | Marking |
|--------------------|--------------------------|-------------------------|-------------------|------------------------|-------------------------|-----------------|---------|
| BPSC000404301R0□00 | 1.0 | 30 | 100 kHz, 1 V | 0.045 | 2.8 | 2.5 | 1R0 |
| BPSC000404303R3□00 | 3.3 | 30 | 100 kHz, 1 V | 0.0721 | 2 | 1.85 | 3R3 |
| BPSC000404304R7□00 | 4.7 | 30 | 100 kHz, 1 V | 0.0883 | 1.65 | 1.62 | 4R7 |
| BPSC000404306R8□00 | 6.8 | 30 | 100 kHz, 1 V | 0.119 | 1.24 | 1.32 | 6R8 |
| BPSC00040430100□00 | 10 | 30 | 100 kHz, 1 V | 0.145 | 1.05 | 1.18 | 100 |
| BPSC00040430150□00 | 15 | 30 | 100 kHz, 1 V | 0.213 | 0.9 | 1.02 | 150 |
| BPSC00040430220□00 | 22 | 30 | 100 kHz, 1 V | 0.335 | 0.76 | 0.74 | 220 |
| BPSC00040430330□00 | 33 | 30 | 100 kHz, 1 V | 0.481 | 0.58 | 0.63 | 330 |
| BPSC00040430470□00 | 47 | 20,30 | 100 kHz, 1 V | 0.599 | 0.48 | 0.56 | 470 |

Note: When ordering, please specify tolerance code. Tolerance: M= \pm 20% , T= \pm 30%

- Operating temperature range - 30°C ~ 100°C(Including self - temperature rise)
- Rated current for Inductance drop 35% from its value with current
- I rms for a 40°C temperature rise from 25°C ambient.
- RDC test method: place testing device to the 2 solder ends of winding and test the value.
- Measure Equipment :
 L : Agilent/ E4980 or HP4284A
 RDC : Chroma 16502
 Rated current : HP4284+42841A or WK3260B+WK3265B
 I rms : HP4284+42841A or WK3260B+WK3265B

SMD Shielded Power Inductors - BPSC Series

Electrical Characteristics

| Part Number | Inductance (μ H) | Tolerance (\pm %) | Test Frequency | RDC (Ω)Max | Rated Current (A) | Irms (A)Typ. | Marking |
|--------------------|--------------------------|-------------------------|-------------------|------------------------|-------------------------|-----------------|---------|
| BPSC00040430100□LD | 10 | 30 | 100 kHz,1 V | 0.095 | 0.5 | 1.52 | 100 |
| BPSC00040430120□LD | 12 | 30 | 100 kHz,1 V | 0.1 | 0.45 | 1.48 | 120 |
| BPSC00040430150□LD | 15 | 30 | 100 kHz,1 V | 0.115 | 0.4 | 1.44 | 150 |
| BPSC00040430180□LD | 18 | 30 | 100 kHz,1 V | 0.125 | 0.35 | 1.37 | 180 |
| BPSC00040430220□LD | 22 | 30 | 100 kHz,1 V | 0.145 | 0.33 | 1.28 | 220 |
| BPSC00040430270□LD | 27 | 30 | 100 kHz,1 V | 0.175 | 0.29 | 1.18 | 270 |
| BPSC00040430330□LD | 33 | 30 | 100 kHz,1 V | 0.215 | 0.28 | 1.15 | 330 |
| BPSC00040430390□LD | 39 | 30 | 100 kHz,1 V | 0.225 | 0.25 | 1 | 390 |
| BPSC00040430470□LD | 47 | 30 | 100 kHz,1 V | 0.305 | 0.23 | 0.81 | 470 |
| BPSC00040430560□LD | 56 | 30 | 100 kHz,1 V | 0.325 | 0.2 | 0.76 | 560 |
| BPSC00040430680□LD | 68 | 30 | 100 kHz,1 V | 0.47 | 0.185 | 0.6 | 680 |
| BPSC00040430820□LD | 82 | 30 | 100 kHz,1 V | 0.54 | 0.172 | 0.58 | 820 |
| BPSC00040430101□LD | 100 | 30 | 100 kHz,1 V | 0.61 | 0.16 | 0.52 | 101 |
| BPSC00040430121□LD | 120 | 30 | 100 kHz,1 V | 0.755 | 0.136 | 0.5 | 121 |
| BPSC00040430151□LD | 150 | 30 | 100 kHz,1 V | 0.88 | 0.124 | 0.48 | 151 |
| BPSC00040430181□LD | 180 | 30 | 100 kHz,1 V | 1.13 | 0.119 | 0.42 | 181 |
| BPSC00040430221□LD | 220 | 30 | 100 kHz,1 V | 1.27 | 0.116 | 0.36 | 221 |

Note: When ordering, please specify tolerance code. Tolerance: M= \pm 20% , T= \pm 30%

- Operating temperature range - 30°C ~ 100°C(Including self - temperature rise)
- Rated current for Inductance drop 35% from its value with current
- I rms for a 40°C temperature rise from 25°C ambient.
- RDC test method: place testing device to the 2 solder ends of winding and test the value.
- Measure Equipment :
 L : Agilent/ E4980 or HP4284A
 RDC : Chroma 16502
 Rated current : HP4284+42841A or WK3260B+WK3265B
 I rms : HP4284+42841A or WK3260B+WK3265B

SMD Shielded Power Inductors - BPSC Series

Packaging Specifications

Tape Dimensions

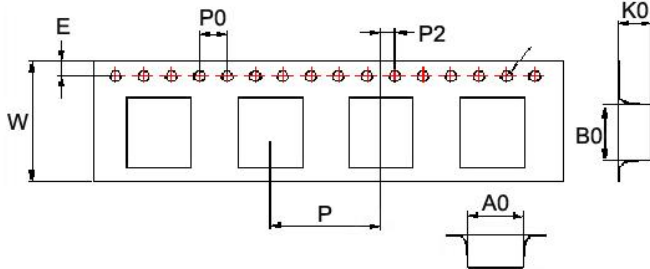

Tape Material

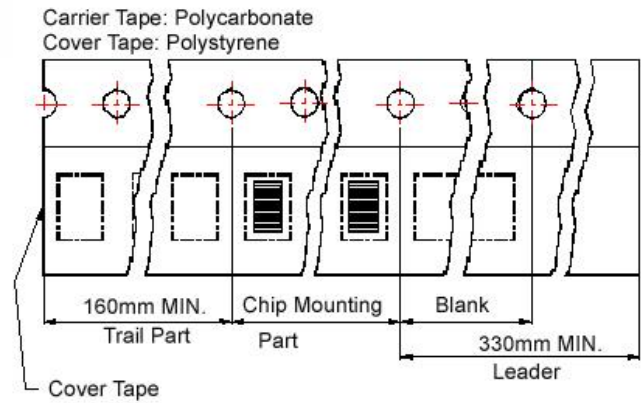

Reel Dimensions

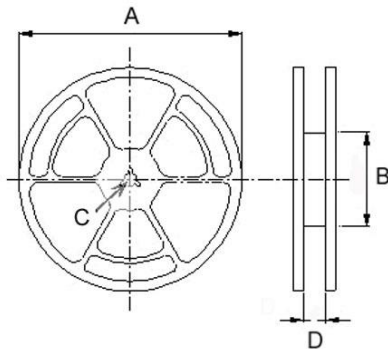

Dimensions in mm

| TYPE | Tape Dimensions | | | | | | | | | Reel Dimensions | | | | Quantity PCS / REEL |
|--------------|-----------------|------|-----|------|------|----|---|----|----|-----------------|----|----|------|------------------------|
| | A0 | B0 | K0 | D | E | W | P | P0 | P2 | A | B | C | D | |
| BPSC00030316 | 3.35 | 3.35 | 1.7 | 1.55 | 1.75 | 12 | 8 | 4 | 2 | 178 | 60 | 13 | 13.2 | 1000 |
| BPSC00030320 | 3.5 | 3.5 | 2.1 | 1.55 | 1.75 | 12 | 8 | 4 | 2 | 178 | 60 | 13 | 13.2 | 1000 |
| BPSC00040412 | 4.2 | 4.2 | 1.5 | 1.55 | 1.75 | 12 | 8 | 4 | 2 | 178 | 60 | 13 | 13.2 | 1000 |
| BPSC00040418 | 4.1 | 4.1 | 2.0 | 1.5 | 1.75 | 12 | 8 | 4 | 2 | 178 | 60 | 13 | 13.2 | 1000 |
| BPSC00040430 | 4.2 | 4.2 | 3.2 | 1.55 | 1.75 | 12 | 8 | 4 | 2 | 178 | 60 | 13 | 13.2 | 500 |

BPSC Series

Features

- RoHS, Halogen Free and REACH Compliance
- Magnetic shielded
- Various package size and wide inductance range

Applications

- AP Routers
- STBs
- LCD TVs and monitors
- Game consoles
- LED lightings
- DC/DC converters

Product Identification

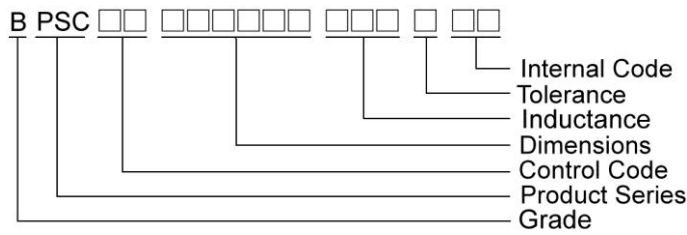

Shape and Dimensions

BPSC00040418

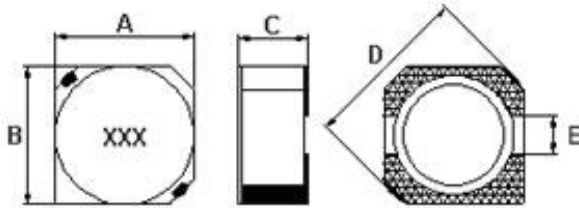

Recommended Pattern

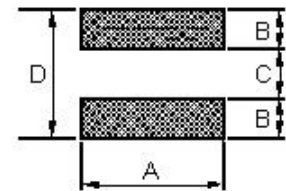

Dimensions in mm

| TYPE | Shape and Dimensions | | | | | Recommended Pattern | | | |
|--------------|----------------------|-----------------|-------------------|-------------------|-----|---------------------|-----|-----|-----|
| | A | B | C | D | E | A | B | C | D |
| BPSC00404018 | 4 ⁺⁰ | 4 ⁺⁰ | 1.8 ⁺⁰ | 5.2 ⁺⁰ | 1.0 | 4.6 | 1.6 | 1.4 | 4.6 |

Shape and Dimensions

BPSC00050520~050540

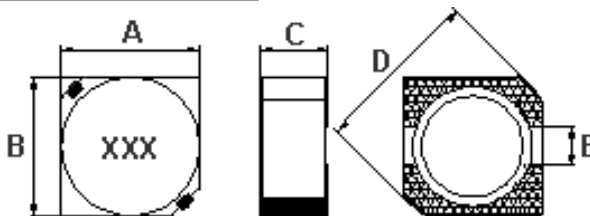

Recommended Pattern

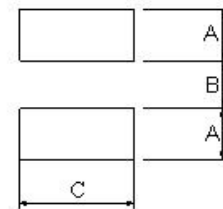

Dimension in mm

| TYPE | Shape and Dimensions | | | | | Recommended Pattern | | |
|--------------|----------------------|---------|-------------------|-------------------|-----|---------------------|-----|-----|
| | A | B | C | D | E | A | B | C |
| BPSC00050520 | 4.7±0.3 | 4.7±0.3 | 2.0 ⁺⁰ | 6.9 ⁺⁰ | 1.5 | 1.9 | 1.5 | 5.3 |
| BPSC00050530 | 4.7±0.3 | 4.7±0.3 | 3.0 ⁺⁰ | 6.9 ⁺⁰ | 1.5 | 1.9 | 1.5 | 5.3 |
| BPSC00050540 | 4.7±0.3 | 4.7±0.3 | 4 ⁺⁰ | 6.9 ⁺⁰ | 1.5 | 1.9 | 1.5 | 5.3 |

SMD Shielded Power Inductors - BPSC Series

Shape and Dimensions

Recommended Pattern

BPSC00060620~070740

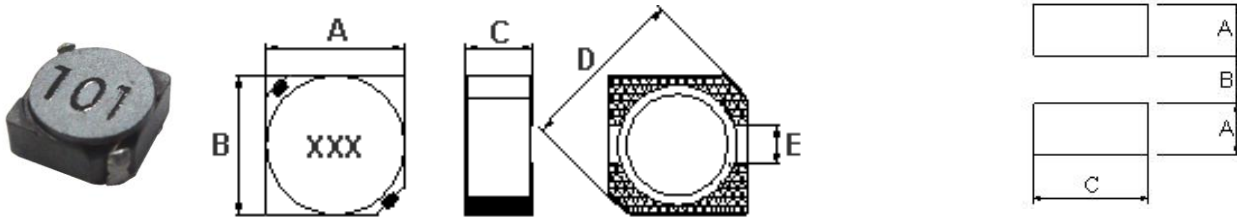

Dimension in mm

| TYPE | Shape and Dimensions | | | | | Recommended Pattern | | |
|--------------|----------------------|-----------------|-------------------|-------------------|-----|---------------------|-----|-----|
| | A | B | C | D | E | A | B | C |
| BPSC00060620 | 5.7±0.3 | 5.7±0.3 | 2.0 ⁺⁰ | 8.2 ⁺⁰ | 2.0 | 2.15 | 2.0 | 6.3 |
| BPSC00060630 | 5.7±0.3 | 5.7±0.3 | 3.0 ⁺⁰ | 8.2 ⁺⁰ | 2.0 | 2.15 | 2.0 | 6.3 |
| BPSC00070730 | 6.7±0.3 | 6.7±0.3 | 3.0 ⁺⁰ | 9.5 ⁺⁰ | 2.0 | 2.65 | 2.0 | 7.3 |
| BPSC00070740 | 7 ⁺⁰ | 7 ⁺⁰ | 4 ⁺⁰ | 9.5 ⁺⁰ | 2.0 | 2.65 | 2.0 | 7.3 |

SMD Shielded Power Inductors – BPSC Series

Electrical Characteristics

| Part Number | Inductance (μ H) | Tolerance (\pm %) | Test Frequency | RDC (Ω)Max | Isat(A) Max(Typ.) | Marking |
|--------------------|--------------------------|-------------------------|-------------------|------------------------|----------------------|---------|
| BPSC000404181R0□S0 | 1.0 | 30 | 100 kHz,0.1 V | 0.04 | 1.35(1.70) | 1R0 |
| BPSC000404181R5□S0 | 1.5 | 30 | 100 kHz,0.1 V | 0.052 | 1.25(1.60) | 1R5 |
| BPSC000404182R2□S0 | 2.2 | 30 | 100 kHz,0.1 V | 0.072 | 1.00(1.30) | 2R2 |
| BPSC000404183R3□S0 | 3.3 | 20,30 | 100 kHz,0.1 V | 0.085 | 0.88(1.10) | 3R3 |
| BPSC000404183R6□S0 | 3.6 | 30 | 100 kHz,0.1 V | 0.09 | 0.74(0.93) | 3R6 |
| BPSC000404184R7□S0 | 4.7 | 20,30 | 100 kHz,0.1 V | 0.105 | 0.72(0.90) | 4R7 |
| BPSC000404186R8□S0 | 6.8 | 20,30 | 100 kHz,0.1 V | 0.17 | 0.61(0.74) | 6R8 |
| BPSC00040418100□S0 | 10 | 20,30 | 100 kHz,0.1 V | 0.21 | 0.55(0.60) | 100 |
| BPSC00040418150□S0 | 15 | 20,30 | 100 kHz,0.1 V | 0.295 | 0.45(0.52) | 150 |
| BPSC00040418220□S0 | 22 | 20,30 | 100 kHz,0.1 V | 0.43 | 0.32(0.40) | 220 |
| BPSC00040418270□S0 | 27 | 30 | 100 kHz,0.1 V | 0.62 | 0.30(0.37) | 270 |
| BPSC00040418330□S0 | 33 | 30 | 100 kHz,0.1 V | 0.675 | 0.26(0.32) | 330 |
| BPSC00040418680□S0 | 68 | 30 | 100 kHz,0.1 V | 1.7 | 0.16(0.21) | 680 |

Note: When ordering, please specify tolerance code. Tolerance: M= \pm 20% , T= \pm 30%

- Operating temperature range - 30°C ~ 100°C(Including self - temperature rise)
- Isat for Inductance drop 35% from its value with current
- RDC test method: place testing device to the 2 solder ends of winding and test the value.
- Measure Equipment :
L : Agilent/ E4980 or HP4284A
RDC : Chroma 16502
Isat : HP4284+42841A or WK3260B+WK3265B

SMD Shielded Power Inductors – BPSC Series

Electrical Characteristics

| Part Number | Inductance (μ H) | Tolerance (\pm %) | Test Frequency | RDC (Ω)Max | Isat(A) Max(Typ.) | Marking |
|--------------------|--------------------------|-------------------------|-------------------|------------------------|----------------------|---------|
| BPSC000505201R0□S0 | 1 | 30 | 7.96 MHz, 1 V | 0.045 | 1.72(2.50) | 1R0 |
| BPSC00050520R5□S0 | 1.5 | 30 | 7.96 MHz, 1 V | 0.06 | 1.50(1.80) | 1R5 |
| BPSC000505201R8□S0 | 1.8 | 30 | 7.96 MHz, 1 V | 0.07 | 1.35(1.70) | 1R8 |
| BPSC000505202R2□S0 | 2.2 | 20,30 | 7.96 MHz, 1 V | 0.075 | 1.30(1.60) | 2R2 |
| BPSC000505202R7□S0 | 2.7 | 30 | 7.96 MHz, 1 V | 0.105 | 1.20(1.50) | 2R7 |
| BPSC000505203R3□S0 | 3.3 | 20,30 | 7.96 MHz, 1 V | 0.11 | 1.04(1.30) | 3R3 |
| BPSC000505203R9□S0 | 3.9 | 30 | 7.96 MHz, 1 V | 0.155 | 0.88(1.20) | 3R9 |
| BPSC000505204R7□S0 | 4.7 | 30 | 7.96 MHz, 1 V | 0.162 | 0.84(1.10) | 4R7 |
| BPSC000505205R6□S0 | 5.6 | 30 | 7.96 MHz, 1 V | 0.17 | 0.80(1.00) | 5R6 |
| BPSC000505206R3□S0 | 6.3 | 30 | 7.96 MHz, 1 V | 0.18 | 0.78(0.95) | 6R3 |
| BPSC000505206R8□S0 | 6.8 | 20,30 | 7.96 MHz, 1 V | 0.2 | 0.76(0.85) | 6R8 |
| BPSC000505208R2□S0 | 8.2 | 30 | 7.96 MHz, 1 V | 0.245 | 0.68(0.80) | 8R2 |
| BPSC00050520100□S0 | 10 | 20,30 | 100 kHz, 1 V | 0.28 | 0.61(0.75) | 100 |
| BPSC00050520120□S0 | 12 | 30 | 100 kHz, 1 V | 0.32 | 0.56(0.70) | 120 |
| BPSC00050520150□S0 | 15 | 30 | 100 kHz, 1 V | 0.36 | 0.50(0.65) | 150 |
| BPSC00050520180□S0 | 18 | 30 | 100 kHz, 1 V | 0.4 | 0.48(0.60) | 180 |
| BPSC00050520220□S0 | 22 | 20,30 | 100 kHz, 1 V | 0.48 | 0.41(0.55) | 220 |
| BPSC00050520270□S0 | 27 | 30 | 100 kHz, 1 V | 0.57 | 0.35(0.50) | 270 |
| BPSC00050520330□S0 | 33 | 30 | 100 kHz, 1 V | 0.694 | 0.32(0.45) | 330 |
| BPSC00050520390□S0 | 39 | 30 | 100 kHz, 1 V | 0.8 | 0.30(0.40) | 390 |
| BPSC00050520470□S0 | 47 | 30 | 100 kHz, 1 V | 0.95 | 0.28(0.38) | 470 |
| BPSC00050520560□S0 | 56 | 30 | 100 kHz, 1 V | 1.08 | 0.26(0.35) | 560 |
| BPSC00050520680□S0 | 68 | 30 | 100 kHz, 1 V | 1.3 | 0.24(0.34) | 680 |
| BPSC00050520101□S0 | 100 | 30 | 100 kHz, 1 V | 2 | 0.20(0.30) | 101 |

Note: When ordering, please specify tolerance code. Tolerance: M= \pm 20% , T= \pm 30%

- Operating temperature range - 30°C ~ 100°C(Including self - temperature rise)
- Isat for Inductance drop 35% from its value with current
- RDC test method: place testing device to the 2 solder ends of winding and test the value.
- Measure Equipment :
L : Agilent/ E4980 or HP4284A (under 1MHz), HP4285A (over 1MHz)
RDC : Chroma 16502
Isat : HP4284+42841A or WK3260B+WK3265B

SMD Shielded Power Inductors – BPSC Series

Electrical Characteristics

| Part Number | Inductance (μ H) | Tolerance (\pm %) | Test Frequency | RDC (Ω)Max | Isat(A) Max(Typ.) | Marking |
|--------------------|--------------------------|-------------------------|-------------------|------------------------|----------------------|---------|
| BPSC000505301R2□S0 | 1.2 | 30 | 100 kHz, 1 V | 0.0236 | 2.56(4.10) | 1R2 |
| BPSC000505301R8□S0 | 1.8 | 30 | 100 kHz, 1 V | 0.035 | 2.20(3.20) | 1R8 |
| BPSC000505302R0□S0 | 2.0 | 30 | 100 kHz, 1 V | 0.030 | 2.10(3.00) | 2R0 |
| BPSC000505302R2□S0 | 2.2 | 20,30 | 100 kHz, 1 V | 0.0313 | 2.04(2.90) | 2R2 |
| BPSC000505302R7□S0 | 2.7 | 30 | 100 kHz, 1 V | 0.0433 | 1.60(2.80) | 2R7 |
| BPSC000505303R3□S0 | 3.3 | 30 | 100 kHz, 1 V | 0.0492 | 1.57(2.30) | 3R3 |
| BPSC000505303R9□S0 | 3.9 | 30 | 100 kHz, 1 V | 0.0648 | 1.44(2.10) | 3R9 |
| BPSC000505304R7□S0 | 4.7 | 20,30 | 100 kHz, 1 V | 0.072 | 1.32(2.00) | 4R7 |
| BPSC000505305R6□S0 | 5.6 | 30 | 100 kHz, 1 V | 0.1009 | 1.17(1.70) | 5R6 |
| BPSC000505306R8□S0 | 6.8 | 20,30 | 100 kHz, 1 V | 0.1089 | 1.12(1.60) | 6R8 |
| BPSC000505308R2□S0 | 8.2 | 30 | 100 kHz, 1 V | 0.1175 | 1.04(1.50) | 8R2 |
| BPSC00050530100□S0 | 10 | 30 | 100 kHz, 1 V | 0.1283 | 1.00(1.30) | 100 |
| BPSC00050530120□S0 | 12 | 20,30 | 100 kHz, 1 V | 0.1316 | 0.84(1.10) | 120 |
| BPSC00050530150□S0 | 15 | 30 | 100 kHz, 1 V | 0.149 | 0.76(1.00) | 150 |
| BPSC00050530180□S0 | 18 | 30 | 100 kHz, 1 V | 0.166 | 0.72(0.99) | 180 |
| BPSC00050530220□S0 | 22 | 20,30 | 100 kHz, 1 V | 0.235 | 0.70(0.93) | 220 |
| BPSC00050530270□S0 | 27 | 30 | 100 kHz, 1 V | 0.261 | 0.58(0.83) | 270 |
| BPSC00050530330□S0 | 33 | 20,30 | 100 kHz, 1 V | 0.3313 | 0.56(0.64) | 330 |
| BPSC00050530390□S0 | 39 | 20,30 | 100 kHz, 1 V | 0.3837 | 0.50(0.70) | 390 |
| BPSC00050530470□S0 | 47 | 30 | 100 kHz, 1 V | 0.587 | 0.48(0.61) | 470 |
| BPSC00050530560□S0 | 56 | 30 | 100 kHz, 1 V | 0.6245 | 0.41(0.54) | 560 |
| BPSC00050530680□S0 | 68 | 30 | 100 kHz, 1 V | 0.699 | 0.35(0.49) | 680 |
| BPSC00050530820□S0 | 82 | 30 | 100 kHz, 1 V | 0.9148 | 0.32(0.49) | 820 |
| BPSC00050530101□S0 | 100 | 20,30 | 100 kHz, 1 V | 1.02 | 0.29(0.45) | 101 |
| BPSC00050530121□S0 | 120 | 30 | 100 kHz, 1 V | 1.27 | 0.27(0.40) | 121 |
| BPSC00050530151□S0 | 150 | 30 | 100 kHz, 1 V | 1.35 | 0.24(0.34) | 151 |
| BPSC00050530181□S0 | 180 | 30 | 100 kHz, 1 V | 1.54 | 0.22(0.32) | 181 |
| BPSC00050530221□S0 | 220 | 30 | 100 kHz, 1 V | 2 | 0.20(0.29) | 221 |
| BPSC00050530331□S0 | 330 | 20,30 | 100 kHz, 1 V | 3.4 | 0.19(0.24) | 331 |
| BPSC00050530391□S0 | 390 | 20,30 | 100 kHz, 1 V | 3.56 | 0.18(0.22) | 391 |
| BPSC00050530681□S0 | 680 | 20,30 | 100 kHz, 1 V | 5.2 | 0.10(0.17) | 681 |

Note: When ordering, please specify tolerance code. Tolerance: M=±20% , T=±30%

- Operating temperature range - 30°C ~ 100°C(Including self - temperature rise)
- Isat for Inductance drop 35% from its value with current
- RDC test method: place testing device to the 2 solder ends of winding and test the value.
- Measure Equipment :
 - L : Agilent/ E4980 or HP4284A (under 1MHz), HP4285A (over 1MHz)
 - RDC : Chroma 16502
 - Isat : HP4284+42841A or WK3260B+WK3265B

Please be sure to request approval specifications that provide further details of the products. Kindly note that the content of these specifications are subject to change or may be discontinued without prior notice. This product may not be designed/used in medical or high risk applications without Chilisin approval. Please contact our sales department before ordering.

SMD Shielded Power Inductors – BPSC Series

Electrical Characteristics

| Part Number | Inductance (μ H) | Tolerance (\pm %) | Test Frequency | RDC (Ω)Max | Isat(A) Max(Typ.) | Irms (A)Typ. | Marking |
|--------------------|--------------------------|-------------------------|-------------------|------------------------|----------------------|-----------------|---------|
| BPSC000505402R2□S0 | 2.2 | 30 | 100 kHz,1V | 0.033 | 3.5(4.6) | 4.3 | 2R2 |
| BPSC000505403R3□S0 | 3.3 | 30 | 100 kHz,1V | 0.039 | 2.7(3.4) | 3.6 | 3R3 |
| BPSC000505404R7□S0 | 4.7 | 20,30 | 100 kHz,1V | 0.053 | 2.4(3.0) | 3 | 4R7 |
| BPSC000505406R8□S0 | 6.8 | 20,30 | 100 kHz,1V | 0.06 | 2.0(2.6) | 2.8 | 6R8 |
| BPSC00050540100□S0 | 10 | 20,30 | 100 kHz,1V | 0.15 | 1.5(2.0) | 1.6 | 100 |
| BPSC00050540150□S0 | 15 | 20,30 | 100 kHz,1V | 0.21 | 1.2(1.6) | 1.35 | 150 |
| BPSC00050540220□S0 | 22 | 20,30 | 100 kHz,1V | 0.27 | 1.0(1.4) | 1 | 220 |

Note: When ordering, please specify tolerance code. Tolerance: M= \pm 20% , T= \pm 30%

- Operating temperature range - 30°C ~ 100°C(Including self - temperature rise)
- Isat for Inductance drop 35% from its value with current
- I rms for a 40°C temperature rise from 25°C ambient.
- RDC test method: place testing device to the 2 solder ends of winding and test the value.
- Measure Equipment :
 - L : Agilent/ E4980 or HP4284A (under 1MHz)
 - RDC : Chroma 16502
 - Isat : HP4284+42841A or WK3260B+WK3265B
 - I rms : HP4284+42841A or WK3260B+WK3265B

SMD Shielded Power Inductors – BPSC Series

Electrical Characteristics

| Part Number | Inductance (μ H) | Tolerance (\pm %) | Test Frequency | RDC (Ω)Max | Isat(A) Max(Typ.) | Marking |
|--------------------|--------------------------|-------------------------|-------------------|------------------------|----------------------|---------|
| BPSC000606201R0□S0 | 1.0 | 30 | 10 kHz,1 V | 0.038 | 1.00(3.50) | 1R0 |
| BPSC000606201R5□S0 | 1.5 | 30 | 10 kHz,1 V | 0.038 | 2.50(3.00) | 1R5 |
| BPSC000606202R0□S0 | 2.0 | 30 | 10 kHz,1 V | 0.045 | 2.10(2.60) | 2R0 |
| BPSC000606202R2□S0 | 2.2 | 30 | 10 kHz,1 V | 0.048 | 2.00(2.50) | 2R2 |
| BPSC000606203R3□S0 | 3.3 | 30 | 10 kHz,1 V | 0.056 | 1.70(2.00) | 3R3 |
| BPSC000606204R1□S0 | 4.1 | 30 | 10 kHz,1 V | 0.057 | 1.55(1.90) | 4R1 |
| BPSC000606204R7□S0 | 4.7 | 20,30 | 10 kHz,1 V | 0.076 | 1.35(1.70) | 4R7 |
| BPSC000606205R4□S0 | 5.4 | 30 | 10 kHz,1 V | 0.076 | 1.20(1.50) | 5R4 |
| BPSC000606206R2□S0 | 6.2 | 30 | 10 kHz,1 V | 0.096 | 1.10(1.40) | 6R2 |
| BPSC000606206R8□S0 | 6.8 | 30 | 10 kHz,1 V | 0.1 | 1.00(1.30) | 6R8 |
| BPSC000606208R9□S0 | 8.9 | 30 | 10 kHz,1 V | 0.116 | 0.95(1.25) | 8R9 |
| BPSC00060620100□S0 | 10 | 20,30 | 10 kHz,1 V | 0.124 | 0.90(1.20) | 100 |
| BPSC00060620120□S0 | 12 | 30 | 10 kHz,1 V | 0.153 | 0.90(1.00) | 120 |
| BPSC00060620150□S0 | 15 | 20,30 | 10 kHz,1 V | 0.196 | 0.80(0.91) | 150 |
| BPSC00060620180□S0 | 18 | 30 | 10 kHz,1 V | 0.21 | 0.75(0.90) | 180 |
| BPSC00060620220□S0 | 22 | 20,30 | 10 kHz,1 V | 0.29 | 0.65(0.80) | 220 |
| BPSC00060620270□S0 | 27 | 30 | 10 kHz,1 V | 0.33 | 0.60(0.70) | 270 |
| BPSC00060620330□S0 | 33 | 20,30 | 10 kHz,1 V | 0.386 | 0.55(0.65) | 330 |
| BPSC00060620390□S0 | 39 | 30 | 10 kHz,1 V | 0.52 | 0.48(0.60) | 390 |
| BPSC00060620470□S0 | 47 | 20,30 | 10 kHz,1 V | 0.595 | 0.44(0.51) | 470 |
| BPSC00060620560□S0 | 56 | 30 | 10 kHz,1 V | 0.665 | 0.40(0.50) | 560 |
| BPSC00060620680□S0 | 68 | 30 | 10 kHz,1 V | 0.84 | 0.33(0.43) | 680 |
| BPSC00060620820□S0 | 82 | 30 | 10 kHz,1 V | 0.978 | 0.30(0.41) | 820 |
| BPSC00060620101□S0 | 100 | 20,30 | 10 kHz,1 V | 1.2 | 0.25(0.36) | 101 |

Note: When ordering, please specify tolerance code. Tolerance: M=±20% , T=±30%

- Operating temperature range - 30°C ~ 100°C(Including self - temperature rise)
- Isat for Inductance drop 35% from its value with current
- RDC test method: place testing device to the 2 solder ends of winding and test the value.
- Measure Equipment :
 - L : Agilent/ E4980 or HP4284A
 - RDC : Chroma 16502
 - Isat : HP4284+42841A or WK3260B+WK3265B

SMD Shielded Power Inductors – BPSC Series

Electrical Characteristics

| Part Number | Inductance (μ H) | Tolerance (\pm %) | Test Frequency | RDC (Ω)Max | Isat(A) Max(Typ.) | Marking |
|--------------------|--------------------------|-------------------------|-------------------|------------------------|----------------------|---------|
| BPSC000606301R0□S0 | 1.0 | 30 | 10 kHz,1 V | 0.015 | 3.50(4.20) | 1R0 |
| BPSC000606301R5□S0 | 1.5 | 30 | 10 kHz,1 V | 0.015 | 2.80(3.70) | 1R5 |
| BPSC000606302R2□S0 | 2.2 | 30 | 10 kHz,1 V | 0.018 | 2.40(3.10) | 2R2 |
| BPSC000606302R5□S0 | 2.5 | 30 | 10 kHz,1 V | 0.022 | 2.30(2.70) | 2R5 |
| BPSC000606302R6□S0 | 2.6 | 30 | 10 kHz,1 V | 0.022 | 2.20(2.60) | 2R6 |
| BPSC000606302R7□S0 | 2.7 | 30 | 10 kHz,1 V | 0.024 | 2.20(2.60) | 2R7 |
| BPSC000606303R0□S0 | 3.0 | 30 | 10 kHz,1 V | 0.024 | 2.20(2.50) | 3R0 |
| BPSC000606303R3□S0 | 3.3 | 30 | 10 kHz,1 V | 0.027 | 2.10(2.50) | 3R3 |
| BPSC000606304R2□S0 | 4.2 | 30 | 10 kHz,1 V | 0.031 | 2.00(2.20) | 4R2 |
| BPSC000606304R3□S0 | 4.3 | 30 | 10 kHz,1 V | 0.041 | 1.80(2.10) | 4R3 |
| BPSC000606304R7□S0 | 4.7 | 20,30 | 10 kHz,1 V | 0.038 | 1.60(2.00) | 4R7 |
| BPSC000606305R0□S0 | 5.0 | 30 | 10 kHz,1 V | 0.038 | 1.50(1.90) | 5R0 |
| BPSC000606305R3□S0 | 5.3 | 20,30 | 10 kHz,1 V | 0.038 | 1.50(1.90) | 5R3 |
| BPSC000606306R2□S0 | 6.2 | 20,30 | 10 kHz,1 V | 0.045 | 1.20(1.80) | 6R2 |
| BPSC000606306R8□S0 | 6.8 | 20,30 | 10 kHz,1 V | 0.05 | 1.20(1.60) | 6R8 |
| BPSC000606308R2□S0 | 8.2 | 20,30 | 10 kHz,1 V | 0.053 | 1.00(1.50) | 8R2 |
| BPSC00060630100□S0 | 10 | 20,30 | 10 kHz,1 V | 0.065 | 0.95(1.40) | 100 |
| BPSC00060630120□S0 | 12 | 20,30 | 10 kHz,1 V | 0.076 | 0.90(1.30) | 120 |
| BPSC00060630150□S0 | 15 | 20,30 | 10 kHz,1 V | 0.103 | 0.85(1.10) | 150 |
| BPSC00060630180□S0 | 18 | 30 | 10 kHz,1 V | 0.11 | 0.80(1.00) | 180 |
| BPSC00060630220□S0 | 22 | 20,30 | 10 kHz,1 V | 0.122 | 0.75(0.92) | 220 |
| BPSC00060630270□S0 | 27 | 30 | 10 kHz,1 V | 0.175 | 0.65(0.82) | 270 |
| BPSC00060630330□S0 | 33 | 30 | 10 kHz,1 V | 0.189 | 0.60(0.75) | 330 |
| BPSC00060630390□S0 | 39 | 30 | 10 kHz,1 V | 0.212 | 0.55(0.70) | 390 |
| BPSC00060630470□S0 | 47 | 20,30 | 10 kHz,1 V | 0.25 | 0.50(0.62) | 470 |
| BPSC00060630560□S0 | 56 | 30 | 10 kHz,1 V | 0.305 | 0.48(0.59) | 560 |
| BPSC00060630680□S0 | 68 | 30 | 10 kHz,1 V | 0.355 | 0.42(0.52) | 680 |
| BPSC00060630820□S0 | 82 | 30 | 10 kHz,1 V | 0.463 | 0.39(0.46) | 820 |

Note: When ordering, please specify tolerance code. Tolerance: M= \pm 20% , T= \pm 30%

- Operating temperature range - 30°C ~ 100°C(Including self - temperature rise)
- Isat for Inductance drop 35% from its value with current
- RDC test method: place testing device to the 2 solder ends of winding and test the value.
- Measure Equipment :
L : Agilent/ E4980 or HP4284A
RDC : Chroma 16502
Isat : HP4284+42841A or WK3260B+WK3265B

Please be sure to request approval specifications that provide further details of the products. Kindly note that the content of these specifications are subject to change or may be discontinued without prior notice. This product may not be designed/used in medical or high risk applications without Chilisin approval. Please contact our sales department before ordering.

SMD Shielded Power Inductors – BPSC Series

Electrical Characteristics

| Part Number | Inductance (μ H) | Tolerance (\pm %) | Test Frequency | RDC (Ω)Max | Isat(A) Max(Typ.) | Marking |
|--------------------|--------------------------|-------------------------|-------------------|------------------------|----------------------|---------|
| BPSC00060630101□S0 | 100 | 20,30 | 10 kHz,1 V | 0.52 | 0.35(0.42) | 101 |
| BPSC00060630181□S0 | 180 | 30 | 10 kHz,1 V | 1.05 | 0.21(0.31) | 181 |
| BPSC00060630221□S0 | 220 | 30 | 10 kHz,1 V | 1.2 | 0.20(0.30) | 221 |
| BPSC00060630331□S0 | 330 | 20,30 | 10 kHz,1 V | 1.7 | 0.15(0.24) | 331 |
| BPSC00060630391□S0 | 390 | 30 | 10 kHz,1 V | 1.8 | 0.13(0.22) | 391 |
| BPSC00060630471□S0 | 470 | 20,30 | 10 kHz,1 V | 2.5 | 0.11(0.21) | 471 |
| BPSC00060630561□S0 | 560 | 20,30 | 10 kHz,1 V | 3.2 | 0.10(0.17) | 561 |

Note: When ordering, please specify tolerance code. Tolerance: M= \pm 20% , T= \pm 30% , N= \pm 40% -20%

- Operating temperature range - 30°C ~ 100°C(Including self - temperature rise)
- Isat for Inductance drop 35% from its value with current
- RDC test method: place testing device to the 2 solder ends of winding and test the value.
- Measure Equipment :
 - L : Agilent/ E4980 or HP4284A
 - RDC : Chroma 16502
 - Isat : HP4284+42841A or WK3260B+WK3265B

SMD Shielded Power Inductors – BPSC Series

Electrical Characteristics

| Part Number | Inductance (μ H) | Tolerance (\pm %) | Test Frequency | RDC (Ω)Max | Isat(A) Max(Typ.) | Marking |
|--------------------|--------------------------|-------------------------|-------------------|------------------------|----------------------|---------|
| BPSC000707301R0□S0 | 1.0 | 30 | 10 kHz,1 V | 0.024 | 3.50(5.30) | 1R0 |
| BPSC000707301R5□S0 | 1.5 | 30 | 10 kHz,1 V | 0.0195 | 3.40(4.50) | 1R5 |
| BPSC000707302R2□S0 | 2.2 | 20,30 | 10 kHz,1 V | 0.035 | 3.00(3.40) | 2R2 |
| BPSC000707303R0□S0 | 3 | 30 | 10 kHz,1 V | 0.024 | 2.60(3.20) | 3R0 |
| BPSC000707303R3□S0 | 3.3 | 30 | 10 kHz,1 V | 0.025 | 2.50(3.10) | 3R3 |
| BPSC000707303R9□S0 | 3.9 | 30 | 10 kHz,1 V | 0.027 | 2.30(2.90) | 3R9 |
| BPSC000707304R7□S0 | 4.7 | 20,30 | 10 kHz,1 V | 0.031 | 1.92(2.40) | 4R7 |
| BPSC000707305R0□S0 | 5.0 | 30 | 10 kHz,1 V | 0.031 | 1.74(2.40) | 5R0 |
| BPSC000707306R0□S0 | 6.0 | 30 | 10 kHz,1 V | 0.035 | 1.70(2.25) | 6R0 |
| BPSC000707306R2□S0 | 6.2 | 20,30 | 10 kHz,1 V | 0.051 | 1.40(2.20) | 6R2 |
| BPSC000707306R8□S0 | 6.8 | 20,30 | 10 kHz,1 V | 0.05 | 1.30(2.15) | 6R8 |
| BPSC000707307R3□S0 | 7.3 | 30 | 10 kHz,1 V | 0.054 | 1.25(2.10) | 7R3 |
| BPSC000707308R6□S0 | 8.6 | 30 | 10 kHz,1 V | 0.058 | 1.20(1.85) | 8R6 |
| BPSC00070730100□S0 | 10 | 20,30 | 10 kHz,1 V | 0.065 | 1.15(1.70) | 100 |
| BPSC00070730120□S0 | 12 | 20,30 | 10 kHz,1 V | 0.07 | 1.14(1.50) | 120 |
| BPSC00070730150□S0 | 15 | 20,30 | 10 kHz,1 V | 0.084 | 1.12(1.40) | 150 |
| BPSC00070730180□S0 | 18 | 30 | 10 kHz,1 V | 0.095 | 1.02(1.32) | 180 |
| BPSC00070730220□S0 | 22 | 30 | 10 kHz,1 V | 0.128 | 0.87(1.20) | 220 |
| BPSC00070730270□S0 | 27 | 30 | 10 kHz,1 V | 0.142 | 0.82(1.05) | 270 |
| BPSC00070730330□S0 | 33 | 30 | 10 kHz,1 V | 0.165 | 0.80(0.97) | 330 |
| BPSC00070730390□S0 | 39 | 30 | 10 kHz,1 V | 0.21 | 0.79(0.90) | 390 |
| BPSC00070730470□S0 | 47 | 20,30 | 10 kHz,1 V | 0.238 | 0.70(0.80) | 470 |
| BPSC00070730560□S0 | 56 | 30 | 10 kHz,1 V | 0.277 | 0.60(0.73) | 560 |
| BPSC00070730680□S0 | 68 | 30 | 10 kHz,1 V | 0.304 | 0.55(0.65) | 680 |
| BPSC00070730820□S0 | 82 | 30 | 10 kHz,1 V | 0.39 | 0.48(0.60) | 820 |
| BPSC00070730101□S0 | 100 | 30 | 10 kHz,1 V | 0.535 | 0.43(0.54) | 101 |
| BPSC00070730121□S0 | 120 | 20,30 | 10 kHz,1 V | 0.6 | 0.36(0.45) | 121 |
| BPSC00070730221□S0 | 220 | 20,30 | 10 kHz,1 V | 1.3 | 0.27(0.34) | 221 |

Note: When ordering, please specify tolerance code. Tolerance: M= \pm 20% , T= \pm 30%

- Operating temperature range - 30°C ~ 100°C(Including self - temperature rise)
- Isat for Inductance drop 35% from its value with current
- RDC test method: place testing device to the 2 solder ends of winding and test the value.
- Measure Equipment :
L : Agilent/ E4980 or HP4284A
RDC : Chroma 16502
Isat : HP4284+42841A or WK3260B+WK3265B

Please be sure to request approval specifications that provide further details of the products. Kindly note that the content of these specifications are subject to change or may be discontinued without prior notice. This product may not be designed/used in medical or high risk applications without Chilisin approval. Please contact our sales department before ordering.

SMD Shielded Power Inductors – BPSC Series

Electrical Characteristics

| Part Number | Inductance (μ H) | Tolerance (\pm %) | Test Frequency | RDC (Ω)Max | Isat(A) Max(Typ.) | Marking |
|--------------------|--------------------------|-------------------------|-------------------|------------------------|----------------------|---------|
| BPSC000707402R2□S0 | 2.2 | 30 | 10 kHz,0.1 V | 0.018 | 3.80(4.70) | 2R2 |
| BPSC000707402R7□S0 | 2.7 | 30 | 10 kHz,0.1 V | 0.02 | 3.20(4.00) | 2R7 |
| BPSC000707403R3□S0 | 3.3 | 20,30 | 10 kHz,0.1 V | 0.023 | 3.00(3.80) | 3R3 |
| BPSC000707404R7□S0 | 4.7 | 20,30 | 10 kHz,0.1 V | 0.025 | 2.70(3.40) | 4R7 |
| BPSC000707405R0□S0 | 5 | 20,30 | 10 kHz,0.1 V | 0.026 | 2.50(3.10) | 5R0 |
| BPSC000707405R6□S0 | 5.6 | 30 | 10 kHz,0.1 V | 0.027 | 2.30(3.00) | 5R6 |
| BPSC000707406R2□S0 | 6.2 | 20,30 | 10 kHz,0.1 V | 0.027 | 1.80(2.80) | 6R2 |
| BPSC000707406R8□S0 | 6.8 | 30 | 10 kHz,0.1 V | 0.032 | 1.70(2.70) | 6R8 |
| BPSC000707407R4□S0 | 7.4 | 30 | 10 kHz,0.1 V | 0.032 | 1.70(2.50) | 7R4 |
| BPSC000707408R7□S0 | 8.7 | 30 | 10 kHz,0.1 V | 0.034 | 1.70(2.40) | 8R7 |
| BPSC00070740100□S0 | 10 | 20,30 | 10 kHz,0.1 V | 0.041 | 1.60(2.20) | 100 |
| BPSC00070740120□S0 | 12 | 30 | 10 kHz,0.1 V | 0.053 | 1.50(1.90) | 120 |
| BPSC00070740150□S0 | 15 | 20,30 | 10 kHz,0.1 V | 0.057 | 1.40(1.80) | 150 |
| BPSC00070740180□S0 | 18 | 30 | 10 kHz,0.1 V | 0.092 | 1.25(1.60) | 180 |
| BPSC00070740220□S0 | 22 | 20,30 | 10 kHz,0.1 V | 0.096 | 1.10(1.50) | 220 |
| BPSC00070740270□S0 | 27 | 30 | 10 kHz,0.1 V | 0.109 | 0.90(1.20) | 270 |
| BPSC00070740330□S0 | 33 | 20,30 | 10 kHz,0.1 V | 0.124 | 0.85(1.10) | 330 |
| BPSC00070740390□S0 | 39 | 20,30 | 10 kHz,0.1 V | 0.138 | 0.80(1.10) | 390 |
| BPSC00070740470□S0 | 47 | 20,30 | 10 kHz,0.1 V | 0.15 | 0.70(1.00) | 470 |
| BPSC00070740560□S0 | 56 | 30 | 10 kHz,0.1 V | 0.202 | 0.65(0.90) | 560 |
| BPSC00070740680□S0 | 68 | 20,30 | 10 kHz,0.1 V | 0.234 | 0.60(0.80) | 680 |
| BPSC00070740820□S0 | 82 | 30 | 10 kHz,0.1 V | 0.324 | 0.55(0.70) | 820 |
| BPSC00070740101□S0 | 100 | 20,30 | 10 kHz,0.1 V | 0.358 | 0.50(0.65) | 101 |
| BPSC00070740561□S0 | 560 | 30 | 10 kHz,0.1 V | 1.8 | 0.20(0.25) | 561 |

Note: When ordering, please specify tolerance code. Tolerance: M= \pm 20% , T= \pm 30%

- Operating temperature range - 30°C ~ 100°C(Including self - temperature rise)
- Isat for Inductance drop 35% from its value with current
- RDC test method: place testing device to the 2 solder ends of winding and test the value.
- Measure Equipment :
 - L : Agilent/ E4980 or HP4284A
 - RDC : Chroma 16502
 - Isat : HP4284+42841A or WK3260B+WK3265B

SMD Shielded Power Inductors - BPSC Series

Packaging Specifications

Tape Dimensions

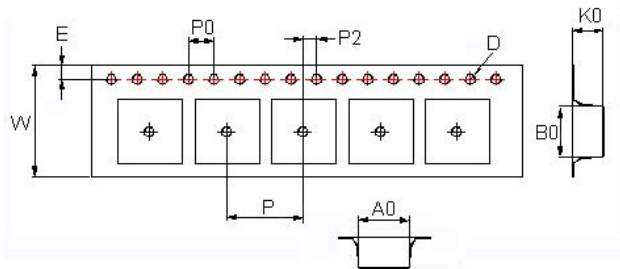

Tape Material

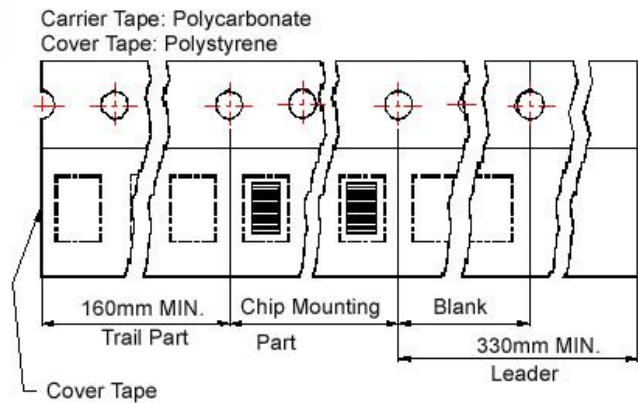

Reel Dimensions

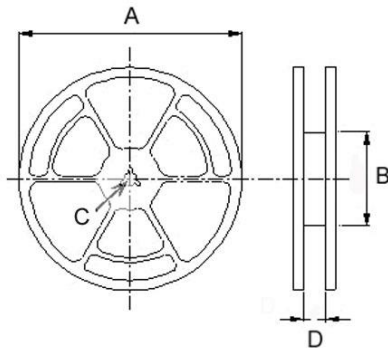

Dimensions in mm

| TYPE | Tape Dimensions | | | | | | | | | Reel Dimensions | | | | Quantity PCS / REEL |
|--------------|-----------------|------|------|------|------|----|----|----|----|-----------------|-----|----|------|------------------------|
| | A0 | B0 | K0 | D | E | W | P | P0 | P2 | A | B | C | D | |
| BPSC00404018 | 4.1 | 4.1 | 2.0 | 1.5 | 1.75 | 12 | 8 | 4 | 2 | 178 | 60 | 13 | 13.2 | 1000 |
| BPSC00050520 | 5.3 | 5.3 | 2.4 | 1.5 | 1.75 | 12 | 8 | 4 | 2 | 330 | 100 | 13 | 13.4 | 2000 |
| BPSC00050530 | 5.3 | 5.3 | 3.4 | 1.5 | 1.75 | 12 | 8 | 4 | 2 | 330 | 100 | 13 | 13.4 | 2000 |
| BPSC00050540 | 5.35 | 5.35 | 4.1 | 1.55 | 1.75 | 12 | 8 | 4 | 2 | 330 | 100 | 13 | 13.4 | 1000 |
| BPSC00060620 | 6.2 | 6.2 | 2.2 | 1.55 | 1.75 | 16 | 12 | 4 | 2 | 330 | 100 | 13 | 13.4 | 1500 |
| BPSC00060630 | 6.2 | 6.2 | 3.1 | 1.55 | 1.75 | 16 | 12 | 4 | 2 | 330 | 100 | 13 | 17.4 | 1500 |
| BPSC00070730 | 7.25 | 7.25 | 3.35 | 1.55 | 1.75 | 16 | 12 | 4 | 2 | 330 | 100 | 13 | 17.4 | 1500 |
| BPSC00070740 | 7.1 | 7.1 | 4.1 | 1.55 | 1.75 | 16 | 12 | 4 | 2 | 330 | 100 | 13 | 17.4 | 1000 |

BPSC Series

Features

- RoHS, Halogen Free and REACH Compliance
- Magnetic shielded
- Various package size and wide inductance range

Applications

- AP Routers
- STBs
- LCD TVs and monitors
- Game consoles
- LED lightings
- DC/DC converters

Product Identification

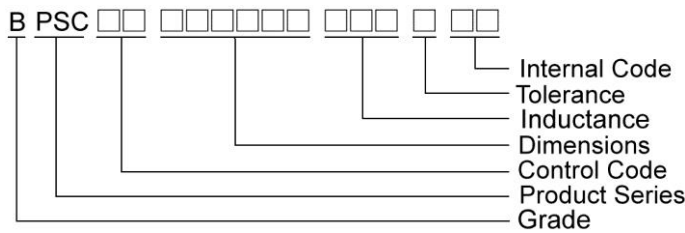

Shape and Dimensions

BPSC00070734/070745

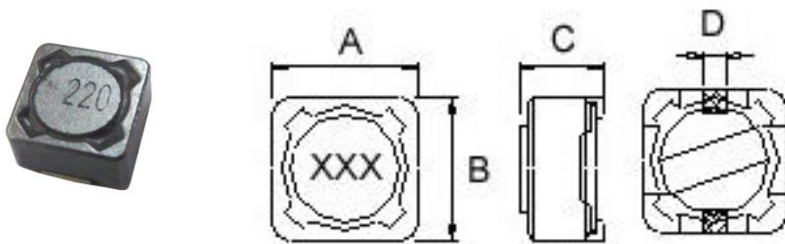

Recommended Pattern

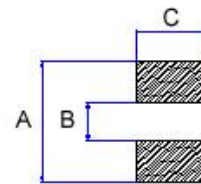

Dimension in mm

| TYPE | Shape and Dimensions | | | | Recommended Pattern | | |
|--------------|----------------------|---------|-------------------|-----|---------------------|-----|-----|
| | A | B | C | D | A | B | C |
| BPSC00070734 | 7.3±0.2 | 7.3±0.2 | 3.4 ⁺⁰ | 1.8 | 8.4 | 4.4 | 2.2 |
| BPSC00070745 | 7.3±0.2 | 7.3±0.2 | 4.5 ⁺⁰ | 1.8 | 8.4 | 4.4 | 2.2 |

Shape and Dimensions

BPSC00101131/101140/101151

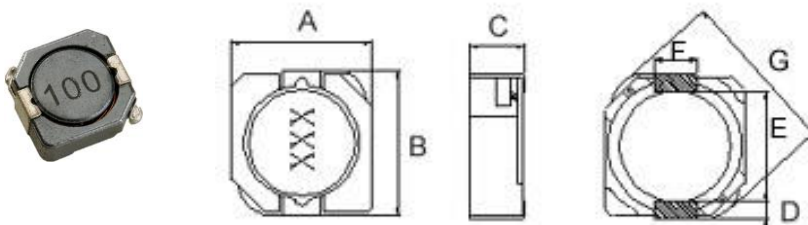

Recommended Pattern

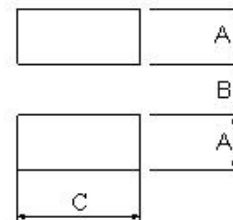

Dimensions in mm

| TYPE | A | B | C | D | E | F | G | A | B | C |
|--------------|--------------------|--------------------|-------------------|-----|-----|-----|--------------------|-----|-----|-----|
| BPSC00101131 | 10.3 ⁺⁰ | 10.5 ⁺⁰ | 3.1 ⁺⁰ | 1.2 | 7.7 | 3.0 | 13.5 ⁺⁰ | 1.6 | 7.3 | 3.2 |
| BPSC00101140 | 10.3 ⁺⁰ | 10.5 ⁺⁰ | 4 ⁺⁰ | 1.2 | 7.7 | 3.0 | 13.5 ⁺⁰ | 1.6 | 7.3 | 3.2 |
| BPSC00101151 | 10.3 ⁺⁰ | 10.5 ⁺⁰ | 5.1 ⁺⁰ | 1.2 | 7.7 | 3.0 | 13.5 ⁺⁰ | 1.6 | 7.3 | 3.2 |

SMD Shielded Power Inductors – BPSC Series

Shape and Dimensions

Recommended Pattern

BPSC00131345/131360/131380

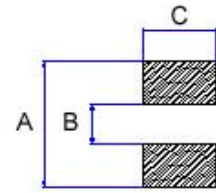
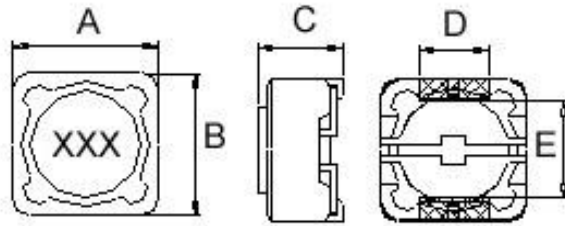

Dimensions in mm

| TYPE | Shape and Dimensions | | | | | Recommended Pattern | | |
|--------------|----------------------|--------------------|-------------------|---|-----|---------------------|---|-----|
| | A | B | C | D | E | A | B | C |
| BPSC00131345 | 12.5 ⁺⁰ | 12.5 ⁺⁰ | 4.5 ⁺⁰ | 5 | 7.6 | 13 | 7 | 5.4 |
| BPSC00131360 | 12.5 ⁺⁰ | 12.5 ⁺⁰ | 6 ⁺⁰ | 5 | 7.6 | 13 | 7 | 5.4 |
| BPSC00131380 | 12.5 ⁺⁰ | 12.5 ⁺⁰ | 8 ⁺⁰ | 5 | 7.6 | 13 | 7 | 5.4 |

SMD Shielded Power Inductors – BPSC Series

Electrical Characteristics

| Part Number | Inductance (μ H) | Tolerance (\pm %) | Test Frequency | RDC (Ω) Max | Isat (A) Max | Marking |
|--------------------|--------------------------|-------------------------|-------------------|-------------------------|-----------------|---------|
| BPSC000707341R5□00 | 1.5 | 20 | 1 kHz, 1 V | 0.03 | 4 | 1R5 |
| BPSC000707342R2□00 | 2.2 | 20 | 1 kHz, 1 V | 0.03 | 4 | 2R2 |
| BPSC000707343R3□00 | 3.3 | 20 | 1 kHz, 1 V | 0.04 | 3.7 | 3R3 |
| BPSC000707346R8□00 | 6.8 | 20 | 1 kHz, 1 V | 0.06 | 2 | 6R8 |
| BPSC00070734100□00 | 10 | 20 | 1 kHz, 1 V | 0.072 | 1.68 | 100 |
| BPSC00070734120□00 | 12 | 20 | 1 kHz, 1 V | 0.098 | 1.52 | 120 |
| BPSC00070734150□00 | 15 | 20 | 1 kHz, 1 V | 0.13 | 1.33 | 150 |
| BPSC00070734180□00 | 18 | 20 | 1 kHz, 1 V | 0.14 | 1.2 | 180 |
| BPSC00070734220□00 | 22 | 20 | 1 kHz, 1 V | 0.19 | 1.07 | 220 |
| BPSC00070734270□00 | 27 | 20 | 1 kHz, 1 V | 0.21 | 0.96 | 270 |
| BPSC00070734330□00 | 33 | 20 | 1 kHz, 1 V | 0.24 | 0.91 | 330 |
| BPSC00070734390□00 | 39 | 20 | 1 kHz, 1 V | 0.32 | 0.77 | 390 |
| BPSC00070734470□00 | 47 | 20 | 1 kHz, 1 V | 0.36 | 0.76 | 470 |
| BPSC00070734560□00 | 56 | 20 | 1 kHz, 1 V | 0.47 | 0.68 | 560 |
| BPSC00070734680□00 | 68 | 20 | 1 kHz, 1 V | 0.52 | 0.61 | 680 |
| BPSC00070734820□00 | 82 | 20 | 1 kHz, 1 V | 0.69 | 0.57 | 820 |
| BPSC00070734101□00 | 100 | 20 | 1 kHz, 1 V | 0.79 | 0.5 | 101 |
| BPSC00070734121□00 | 120 | 20 | 1 kHz, 1 V | 0.89 | 0.49 | 121 |
| BPSC00070734151□00 | 150 | 20 | 1 kHz, 1 V | 1.27 | 0.43 | 151 |
| BPSC00070734181□00 | 180 | 20 | 1 kHz, 1 V | 1.45 | 0.39 | 181 |
| BPSC00070734221□00 | 220 | 20 | 1 kHz, 1 V | 1.65 | 0.35 | 221 |
| BPSC00070734271□00 | 270 | 20 | 1 kHz, 1 V | 2.31 | 0.32 | 271 |
| BPSC00070734331□00 | 330 | 20 | 1 kHz, 1 V | 2.62 | 0.28 | 331 |
| BPSC00070734391□00 | 390 | 20 | 1 kHz, 1 V | 2.94 | 0.26 | 391 |
| BPSC00070734471□00 | 470 | 20 | 1 kHz, 1 V | 4.18 | 0.24 | 471 |
| BPSC00070734561□00 | 560 | 20 | 1 kHz, 1 V | 4.67 | 0.22 | 561 |
| BPSC00070734681□00 | 680 | 20 | 1 kHz, 1 V | 5.73 | 0.19 | 681 |
| BPSC00070734821□00 | 820 | 20 | 1 kHz, 1 V | 6.54 | 0.18 | 821 |
| BPSC00070734102□00 | 1000 | 20 | 1 kHz, 1 V | 9.44 | 0.16 | 102 |

Note: When ordering, please specify tolerance code. Tolerance: M=±20%

- Operating temperature range - 40°C ~ 125°C(Including self - temperature rise)
- Isat for Inductance drop 35% from its value with current
- Measure Equipment :
L : Agilent/ E4980 or HP4284A (under 1MHz), HP4285A (over 1MHz)
RDC : Chroma 16502
Isat : HP4284+42841A or WK3260B+WK3265B

Please be sure to request approval specifications that provide further details of the products. Kindly note that the content of these specifications are subject to change or may be discontinued without prior notice. This product may not be designed/used in medical or high risk applications without Chilisin approval. Please contact our sales department before ordering.

SMD Shielded Power Inductors – BPSC Series

Electrical Characteristics

| Part Number | Inductance (μ H) | Tolerance (\pm %) | Test Frequency | RDC (Ω) Max | Isat (A) Max | Marking |
|--------------------|--------------------------|-------------------------|-------------------|-------------------------|-----------------|---------|
| BPSC000707451R5□00 | 1.5 | 20 | 1 kHz, 1 V | 0.02 | 5 | 1R5 |
| BPSC000707452R2□00 | 1.8 | 20 | 1 kHz, 1 V | 0.025 | 4 | 1R8 |
| BPSC000707452R2□00 | 2.2 | 20,30 | 1 kHz, 1 V | 0.025 | 3.5 | 2R2 |
| BPSC000707452R7□00 | 2.7 | 20,30 | 1 kHz, 1 V | 0.03 | 3.5 | 2R7 |
| BPSC000707453R3□00 | 3.3 | 20,30 | 1 kHz, 1 V | 0.035 | 3.5 | 3R3 |
| BPSC000707453R6□00 | 3.6 | 20,30 | 1 kHz, 1 V | 0.035 | 3.2 | 3R6 |
| BPSC000707454R7□00 | 4.7 | 20,30 | 1 kHz, 1 V | 0.035 | 3 | 4R7 |
| BPSC000707456R8□00 | 6.8 | 20 | 1 kHz, 1 V | 0.045 | 2.5 | 6R8 |
| BPSC00070745100□00 | 10 | 20 | 1 kHz, 1 V | 0.049 | 1.84 | 100 |
| BPSC00070745120□00 | 12 | 20 | 1 kHz, 1 V | 0.058 | 1.71 | 120 |
| BPSC00070745150□00 | 15 | 20 | 1 kHz, 1 V | 0.081 | 1.47 | 150 |
| BPSC00070745180□00 | 18 | 20 | 1 kHz, 1 V | 0.091 | 1.31 | 180 |
| BPSC00070745220□00 | 22 | 20 | 1 kHz, 1 V | 0.11 | 1.23 | 220 |
| BPSC00070745270□00 | 27 | 20 | 1 kHz, 1 V | 0.15 | 1.12 | 270 |
| BPSC00070745330□00 | 33 | 20 | 1 kHz, 1 V | 0.17 | 0.96 | 330 |
| BPSC00070745390□00 | 39 | 20 | 1 kHz, 1 V | 0.23 | 0.91 | 390 |
| BPSC00070745470□00 | 47 | 20 | 1 kHz, 1 V | 0.26 | 0.88 | 470 |
| BPSC00070745560□00 | 56 | 20 | 1 kHz, 1 V | 0.35 | 0.75 | 560 |
| BPSC00070745680□00 | 68 | 20 | 1 kHz, 1 V | 0.38 | 0.69 | 680 |
| BPSC00070745820□00 | 82 | 20 | 1 kHz, 1 V | 0.43 | 0.61 | 820 |
| BPSC00070745101□00 | 100 | 20 | 1 kHz, 1 V | 0.61 | 0.6 | 101 |
| BPSC00070745121□00 | 120 | 20 | 1 kHz, 1 V | 0.66 | 0.52 | 121 |
| BPSC00070745151□00 | 150 | 20 | 1 kHz, 1 V | 0.88 | 0.46 | 151 |
| BPSC00070745181□00 | 180 | 20 | 1 kHz, 1 V | 0.98 | 0.42 | 181 |
| BPSC00070745221□00 | 220 | 10,20 | 1 kHz, 1 V | 1.17 | 0.36 | 221 |
| BPSC00070745271□00 | 270 | 10,20 | 1 kHz, 1 V | 1.64 | 0.34 | 271 |
| BPSC00070745331□00 | 330 | 10,20 | 1 kHz, 1 V | 1.86 | 0.32 | 331 |
| BPSC00070745391□00 | 390 | 10,20 | 1 kHz, 1 V | 2.85 | 0.29 | 391 |
| BPSC00070745471□00 | 470 | 10,20 | 1 kHz, 1 V | 3.01 | 0.26 | 471 |
| BPSC00070745561□00 | 560 | 10,20 | 1 kHz, 1 V | 3.62 | 0.23 | 561 |
| BPSC00070745681□00 | 680 | 10,20 | 1 kHz, 1 V | 4.63 | 0.22 | 681 |
| BPSC00070745821□00 | 820 | 10,20 | 1 kHz, 1 V | 5.2 | 0.2 | 821 |
| BPSC00070745102□00 | 1000 | 10,20 | 1 kHz, 1 V | 6 | 0.18 | 102 |

Note: When ordering, please specify tolerance code. Tolerance: K= \pm 10%, M= \pm 20%, T= \pm 30%

- Operating temperature range - 40°C ~ 125°C(Including self - temperature rise)
- Isat for Inductance drop 35% from its value with current
- Measure Equipment :
 - L : Agilent/ E4980 or HP4284A (under 1MHz), HP4285A (over 1MHz)
 - RDC : Chroma 16502
 - Isat : HP4284+42841A or WK3260B+WK3265B

Please be sure to request approval specifications that provide further details of the products. Kindly note that the content of these specifications are subject to change or may be discontinued without prior notice. This product may not be designed/used in medical or high risk applications without Chilisin approval. Please contact our sales department before ordering.

SMD Shielded Power Inductors – BPSC Series

Electrical Characteristics

| Part Number | Inductance (μ H) | Tolerance (\pm %) | Test Frequency | RDC (Ω) Max | Isat (A) Max | Marking |
|--------------------|--------------------------|-------------------------|-------------------|-------------------------|-----------------|---------|
| BPSC001011314R7□00 | 4.7 | 30 | 100 kHz, 1 V | 0.03 | 4.65 | 4R7 |
| BPSC001011316R8□00 | 6.8 | 30 | 100 kHz, 1 V | 0.035 | 3.84 | 6R8 |
| BPSC00101131100□00 | 10 | 20,30 | 100 kHz, 1 V | 0.059 | 3.18 | 100 |
| BPSC00101131150□00 | 15 | 20,30 | 100 kHz, 1 V | 0.091 | 2.6 | 150 |
| BPSC00101131330□00 | 33 | 20,30 | 100 kHz, 1 V | 0.202 | 1.74 | 330 |
| BPSC00101131470□00 | 47 | 20,30 | 100 kHz, 1 V | 0.299 | 1.43 | 470 |
| BPSC00101131560□00 | 56 | 20,30 | 100 kHz, 1 V | 0.325 | 0.9 | 560 |

Note: When ordering, please specify tolerance code. Tolerance: M= \pm 20% , T= \pm 30%

- Operating temperature range - 40°C ~ 125°C(Including self - temperature rise)
- Isat for Inductance drop 35% from its value with current
- Measure Equipment :
 L : Agilent/ E4980 or HP4284A (under 1MHz), HP4285A (over 1MHz)
 RDC : Chroma 16502
 Isat : HP4284+42841A or WK3260B+WK3265B

SMD Shielded Power Inductors – BPSC Series

Electrical Characteristics

| Part Number | Inductance (μ H) | Tolerance (\pm %) | Test Frequency | RDC (Ω) Max | Isat(A) Max(Typ.) | Marking |
|--------------------|--------------------------|-------------------------|-------------------|-------------------------|----------------------|---------|
| BPSC001011401R5□00 | 1.5 | 30,+40-20 | 100 kHz,1 V | 0.0088 | 8.5(10.5) | 1R5 |
| BPSC001011402R2□00 | 2.2 | 30 | 100 kHz,1 V | 0.012 | 8.0(10.5) | 2R2 |
| BPSC001011402R5□00 | 2.5 | 30 | 100 kHz,1 V | 0.012 | 7.5(9.5) | 2R5 |
| BPSC001011403R3□00 | 3.3 | 30 | 100 kHz,1 V | 0.015 | 7.0(8.7) | 3R3 |
| BPSC001011403R8□00 | 3.8 | 30 | 100 kHz,1 V | 0.015 | 6.8(8.5) | 3R8 |
| BPSC001011404R7□00 | 4.7 | 20,30 | 100 kHz,1 V | 0.02 | 5.8(7.3) | 4R7 |
| BPSC001011405R2□00 | 5.2 | 20,30 | 100 kHz,1 V | 0.024 | 5.8(7.3) | 5R2 |
| BPSC001011405R6□00 | 5.6 | 20,30 | 100 kHz,1 V | 0.027 | 5.0(6.5) | 5R6 |
| BPSC001011406R8□00 | 6.8 | 20,30 | 100 kHz,1 V | 0.031 | 5.0(6.5) | 6R8 |
| BPSC001011407R0□00 | 7 | 20,30 | 100 kHz,1 V | 0.031 | 4.8(5.9) | 7R0 |
| BPSC001011408R2□00 | 8.2 | 20,30 | 100 kHz,1 V | 0.036 | 4.5(5.8) | 8R2 |
| BPSC00101140100□00 | 10 | 20,30 | 100 kHz,1 V | 0.04 | 4.0(5.0) | 100 |
| BPSC00101140150□00 | 15 | 20,30 | 100 kHz,1 V | 0.055 | 3.4(4.3) | 150 |
| BPSC00101140180□00 | 18 | 20,30 | 100 kHz,1 V | 0.075 | 2.9(3.6) | 180 |
| BPSC00101140220□00 | 22 | 20,30 | 100 kHz,1 V | 0.08 | 2.6(3.3) | 220 |
| BPSC00101140270□00 | 27 | 20,30 | 100 kHz,1 V | 0.096 | 2.4(3.0) | 270 |
| BPSC00101140330□00 | 33 | 20,30 | 100 kHz,1 V | 0.098 | 2.3(2.9) | 330 |
| BPSC00101140390□00 | 39 | 20,30 | 100 kHz,1 V | 0.12 | 2.1(2.7) | 390 |
| BPSC00101140470□00 | 47 | 20,30 | 100 kHz,1 V | 0.144 | 1.8(2.5) | 470 |
| BPSC00101140560□00 | 56 | 20,30 | 100 kHz,1 V | 0.175 | 1.6(2.1) | 560 |
| BPSC00101140680□00 | 68 | 20,30 | 100 kHz,1 V | 0.204 | 1.4(1.9) | 680 |
| BPSC00101140820□00 | 82 | 20,30 | 100 kHz,1 V | 0.25 | 1.3(1.7) | 820 |
| BPSC00101140101□00 | 100 | 20,30 | 100 kHz,1 V | 0.304 | 1.0(1.6) | 101 |
| BPSC00101140151□00 | 150 | 20,30 | 100 kHz,1 V | 0.506 | 0.96(1.3) | 151 |
| BPSC00101140221□00 | 220 | 20,30 | 100 kHz,1 V | 0.69 | 0.8(1.0) | 221 |
| BPSC00101140331□00 | 330 | 20,30 | 100 kHz,1 V | 1.09 | 0.68(0.86) | 331 |
| BPSC00101140471□00 | 470 | 20,30 | 100 kHz,1 V | 1.6 | 0.6(0.75) | 471 |
| BPSC00101140561□00 | 560 | 20,30 | 100 kHz,1 V | 1.68 | 0.5(0.68) | 561 |

Note: When ordering, please specify tolerance code. Tolerance: M= \pm 20% , T= \pm 30% , N= \pm 40% -20%

- Operating temperature range - 40°C ~ 125°C(Including self - temperature rise)
- Isat for Inductance drop 35% from its value with current
- Measure Equipment :
L : Agilent/ E4980 or HP4284A (under 1MHz), HP4285A (over 1MHz)
RDC : Chroma 16502
Isat : HP4284+42841A or WK3260B+WK3265B

Please be sure to request approval specifications that provide further details of the products. Kindly note that the content of these specifications are subject to change or may be discontinued without prior notice. This product may not be designed/used in medical or high risk applications without Chilisin approval. Please contact our sales department before ordering.

SMD Shielded Power Inductors – BPSC Series

Electrical Characteristics

| Part Number | Inductance (μ H) | Tolerance (\pm %) | Test Frequency | RDC (Ω) Max | Isat(A) Max(Typ.) | Marking |
|--------------------|--------------------------|-------------------------|-------------------|-------------------------|----------------------|---------|
| BPSC00101151R80□00 | 0.8 | 30 | 100 kHz, 1 V | 0.0062 | 10.8(13.5) | R80 |
| BPSC001011511R5□00 | 1.5 | 30 | 100 kHz, 1 V | 0.0081 | 10.3(12.9) | 1R5 |
| BPSC001011512R2□00 | 2.2 | 30 | 100 kHz, 1 V | 0.011 | 9.2(11) | 2R2 |
| BPSC001011513R3□00 | 3.3 | 30 | 100 kHz, 1 V | 0.012 | 7.2(9.0) | 3R3 |
| BPSC001011514R7□00 | 4.7 | 20,30 | 100 kHz, 1 V | 0.014 | 5.6(7.8) | 4R7 |
| BPSC001011516R8□00 | 6.8 | 20,30 | 100 kHz, 1 V | 0.024 | 5.1(6.4) | 6R8 |
| BPSC001011518R2□00 | 8.2 | 20,30 | 100 kHz, 1 V | 0.027 | 4.7(5.9) | 8R2 |
| BPSC00101151100□00 | 10 | 20,30 | 100 kHz, 1 V | 0.028 | 4.4(5.6) | 100 |
| BPSC00101151120□00 | 12 | 20,30 | 100 kHz, 1 V | 0.036 | 3.4(5.8) | 120 |
| BPSC00101151150□00 | 15 | 20,30 | 100 kHz, 1 V | 0.041 | 3.2(4.5) | 150 |
| BPSC00101151180□00 | 18 | 20,30 | 100 kHz, 1 V | 0.046 | 3.0(3.8) | 180 |
| BPSC00101151220□00 | 22 | 20,30 | 100 kHz, 1 V | 0.061 | 2.8(3.6) | 220 |
| BPSC00101151270□00 | 27 | 20,30 | 100 kHz, 1 V | 0.069 | 2.1(3.2) | 270 |
| BPSC00101151330□00 | 33 | 20,30 | 100 kHz, 1 V | 0.084 | 2.0(2.9) | 330 |
| BPSC00101151390□00 | 39 | 20,30 | 100 kHz, 1 V | 0.106 | 1.9(2.6) | 390 |
| BPSC00101151470□00 | 47 | 20,30 | 100 kHz, 1 V | 0.13 | 1.7(2.3) | 470 |
| BPSC00101151560□00 | 56 | 20,30 | 100 kHz, 1 V | 0.149 | 1.6(2.2) | 560 |
| BPSC00101151680□00 | 68 | 20,30 | 100 kHz, 1 V | 0.201 | 1.5(2.0) | 680 |
| BPSC00101151820□00 | 82 | 20,30 | 100 kHz, 1 V | 0.227 | 1.3(1.8) | 820 |
| BPSC00101151101□00 | 100 | 20,30 | 100 kHz, 1 V | 0.253 | 1.2(1.7) | 101 |
| BPSC00101151121□00 | 120 | 20,30 | 100 kHz, 1 V | 0.303 | 1.1(1.5) | 121 |
| BPSC00101151151□00 | 150 | 20,30 | 100 kHz, 1 V | 0.42 | 1.0(1.3) | 151 |
| BPSC00101151181□00 | 180 | 20,30 | 100 kHz, 1 V | 0.45 | 0.9(1.2) | 181 |
| BPSC00101151221□00 | 220 | 20,30 | 100 kHz, 1 V | 0.54 | 0.8(1.1) | 221 |
| BPSC00101151271□00 | 270 | 20,30 | 100 kHz, 1 V | 0.672 | 0.75(0.99) | 271 |
| BPSC00101151331□00 | 330 | 20,30 | 100 kHz, 1 V | 0.812 | 0.74(0.92) | 331 |
| BPSC00101151391□00 | 390 | 20,30 | 100 kHz, 1 V | 0.953 | 0.62(0.83) | 391 |
| BPSC00101151471□00 | 470 | 20,30 | 100 kHz, 1 V | 1.29 | 0.6(0.77) | 471 |
| BPSC00101151561□00 | 560 | 20,30 | 100 kHz, 1 V | 1.43 | 0.47(0.71) | 561 |
| BPSC00101151681□00 | 680 | 20,30 | 100 kHz, 1 V | 1.6 | 0.46(0.65) | 681 |
| BPSC00101151821□00 | 820 | 20,30 | 100 kHz, 1 V | 1.77 | 0.42(0.57) | 821 |
| BPSC00101151102□00 | 1000 | 20,30 | 100 kHz, 1 V | 2.2 | 0.40(0.54) | 102 |

Note: When ordering, please specify tolerance code. Tolerance: M=±20% , T=±30%

- Operating temperature range - 40°C ~ 125°C(Including self - temperature rise)
- Isat for Inductance drop 35% from its value with current
- Measure Equipment :
L : Agilent/ E4980 or HP4284A (under 1MHz), HP4285A (over 1MHz)
RDC : Chroma 16502
Isat : HP4284+42841A or WK3260B+WK3265B

Please be sure to request approval specifications that provide further details of the products. Kindly note that the content of these specifications are subject to change or may be discontinued without prior notice. This product may not be designed/used in medical or high risk applications without Chilisin approval. Please contact our sales department before ordering.

SMD Shielded Power Inductors – BPSC Series

Electrical Characteristics

| Part Number | Inductance (μ H) | Tolerance (\pm %) | Test Frequency | RDC (Ω) Max | Isat(A) Max(Typ.) | Marking |
|--------------------|--------------------------|-------------------------|-------------------|-------------------------|----------------------|---------|
| BPSC001313453R3□00 | 3.3 | 30 | 100 kHz, 1 V | 0.015 | 8.8(11.1) | 3R3 |
| BPSC001313453R9□00 | 3.9 | 30 | 100 kHz, 1 V | 0.016 | 8.0(10.1) | 3R9 |
| BPSC001313454R7□00 | 4.7 | 20,30 | 100 kHz, 1 V | 0.018 | 7.9(9.9) | 4R7 |
| BPSC001313456R8□00 | 6.8 | 20,30 | 100 kHz, 1 V | 0.023 | 6.5(8.3) | 6R8 |
| BPSC00131345100□00 | 10 | 20,30 | 100 kHz, 1 V | 0.035 | 5.2(6.6) | 100 |
| BPSC00131345120□00 | 12 | 20,30 | 100 kHz, 1 V | 0.038 | 4.8(6.2) | 120 |
| BPSC00131345150□00 | 15 | 20,30 | 100 kHz, 1 V | 0.05 | 4.1(5.4) | 150 |
| BPSC00131345180□00 | 18 | 20,30 | 100 kHz, 1 V | 0.057 | 4.0(5.1) | 180 |
| BPSC00131345220□00 | 22 | 20,30 | 100 kHz, 1 V | 0.066 | 3.5(4.4) | 220 |
| BPSC00131345270□00 | 27 | 20,30 | 100 kHz, 1 V | 0.08 | 3.1(3.9) | 270 |
| BPSC00131345330□00 | 33 | 20,30 | 100 kHz, 1 V | 0.097 | 2.7(3.5) | 330 |
| BPSC00131345390□00 | 39 | 20,30 | 100 kHz, 1 V | 0.132 | 2.1(3.2) | 390 |
| BPSC00131345470□00 | 47 | 20,30 | 100 kHz, 1 V | 0.15 | 1.9(2.9) | 470 |
| BPSC00131345560□00 | 56 | 20,30 | 100 kHz, 1 V | 0.19 | 1.8(2.6) | 560 |
| BPSC00131345680□00 | 68 | 20,30 | 100 kHz, 1 V | 0.22 | 1.5(2.5) | 680 |
| BPSC00131345820□00 | 82 | 20,30 | 100 kHz, 1 V | 0.26 | 1.3(2.3) | 820 |
| BPSC00131345101□00 | 100 | 20,30 | 100 kHz, 1 V | 0.308 | 1.2(2.0) | 101 |
| BPSC00131345121□00 | 120 | 20,30 | 100 kHz, 1 V | 0.38 | 1.1(1.8) | 121 |
| BPSC00131345151□00 | 150 | 20,30 | 100 kHz, 1 V | 0.53 | 0.95(1.6) | 151 |
| BPSC00131345181□00 | 180 | 20,30 | 100 kHz, 1 V | 0.62 | 0.85(1.4) | 181 |
| BPSC00131345221□00 | 220 | 20,30 | 100 kHz, 1 V | 0.7 | 0.8(1.3) | 221 |
| BPSC00131345271□00 | 270 | 20,30 | 100 kHz, 1 V | 0.876 | 0.6(1.1) | 271 |
| BPSC00131345331□00 | 330 | 20,30 | 100 kHz, 1 V | 0.99 | 0.5(1.0) | 331 |

Note: When ordering, please specify tolerance code. Tolerance: M= \pm 20% , T= \pm 30%

- Operating temperature range - 40°C ~ 125°C(Including self - temperature rise)
- Isat for Inductance drop 35% from its value with current
- Measure Equipment :
L : Agilent/ E4980 or HP4284A (under 1MHz), HP4285A (over 1MHz)
RDC : Chroma 16502
Isat : HP4284+42841A or WK3260B+WK3265B

SMD Shielded Power Inductors – BPSC Series

Electrical Characteristics

| Part Number | Inductance (μ H) | Tolerance (\pm %) | Test Frequency | RDC (Ω) Max | Isat(A) Max(Typ.) | Marking |
|--------------------|--------------------------|-------------------------|-------------------|-------------------------|----------------------|---------|
| BPSC001313603R3□00 | 3.3 | 30 | 1 kHz, 1 V | 0.015 | 8.0(11) | 3R3 |
| BPSC001313604R7□00 | 4.7 | 20,30 | 1 kHz, 1 V | 0.018 | 7.6(9.2) | 4R7 |
| BPSC001313606R4□00 | 6.4 | 20,30 | 1 kHz, 1 V | 0.018 | 6.4(8.1) | 6R4 |
| BPSC001313608R2□00 | 8.2 | 20,30 | 1 kHz, 1 V | 0.02 | 5.8(7.4) | 8R2 |
| BPSC00131360100□00 | 10 | 20,30 | 1 kHz, 1 V | 0.025 | 5.3(6.8) | 100 |
| BPSC00131360120□00 | 12 | 20,30 | 1 kHz, 1 V | 0.027 | 5.3(6.8) | 120 |
| BPSC00131360150□00 | 15 | 20,30 | 1 kHz, 1 V | 0.03 | 4.0(5.2) | 150 |
| BPSC00131360180□00 | 18 | 20,30 | 1 kHz, 1 V | 0.034 | 3.8(4.9) | 180 |
| BPSC00131360220□00 | 22 | 20,30 | 1 kHz, 1 V | 0.036 | 3.6(4.8) | 220 |
| BPSC00131360270□00 | 27 | 20,30 | 1 kHz, 1 V | 0.051 | 3.2(4.1) | 270 |
| BPSC00131360330□00 | 33 | 20,30 | 1 kHz, 1 V | 0.057 | 2.9(3.7) | 330 |
| BPSC00131360390□00 | 39 | 20,30 | 1 kHz, 1 V | 0.068 | 2.7(3.5) | 390 |
| BPSC00131360470□00 | 47 | 20,30 | 1 kHz, 1 V | 0.084 | 2.4(3.1) | 470 |
| BPSC00131360560□00 | 56 | 20,30 | 1 kHz, 1 V | 0.1 | 2.1(2.7) | 560 |
| BPSC00131360680□00 | 68 | 20,30 | 1 kHz, 1 V | 0.12 | 2.0(2.6) | 680 |
| BPSC00131360820□00 | 82 | 20,30 | 1 kHz, 1 V | 0.14 | 1.8(2.3) | 820 |
| BPSC00131360101□00 | 100 | 20,30 | 1 kHz, 1 V | 0.16 | 1.6(2.1) | 101 |
| BPSC00131360121□00 | 120 | 20,30 | 1 kHz, 1 V | 0.18 | 1.5(1.9) | 121 |
| BPSC00131360151□00 | 150 | 20,30 | 1 kHz, 1 V | 0.23 | 1.3(1.7) | 151 |
| BPSC00131360181□00 | 180 | 20,30 | 1 kHz, 1 V | 0.29 | 1.2(1.6) | 181 |
| BPSC00131360221□00 | 220 | 20,30 | 1 kHz, 1 V | 0.32 | 1.0(1.4) | 221 |
| BPSC00131360271□00 | 270 | 20,30 | 1 kHz, 1 V | 0.38 | 0.90(1.2) | 271 |
| BPSC00131360331□00 | 330 | 20,30 | 1 kHz, 1 V | 0.48 | 0.75(1.1) | 331 |
| BPSC00131360391□00 | 390 | 20,30 | 1 kHz, 1 V | 0.6 | 0.70(1.0) | 391 |
| BPSC00131360471□00 | 470 | 20,30 | 1 kHz, 1 V | 0.7 | 0.65(0.99) | 471 |
| BPSC00131360561□00 | 560 | 20,30 | 1 kHz, 1 V | 0.86 | 0.60(0.91) | 561 |
| BPSC00131360681□00 | 680 | 20,30 | 1 kHz, 1 V | 1.1 | 0.55(0.82) | 681 |
| BPSC00131360821□00 | 820 | 20,30 | 1 kHz, 1 V | 1.34 | 0.50(0.71) | 821 |
| BPSC00131360102□00 | 1000 | 20,30 | 1 kHz, 1 V | 1.53 | 0.45(0.64) | 102 |

Note: When ordering, please specify tolerance code. Tolerance: M=±20% , T=±30%

- Operating temperature range - 40°C ~ 125°C(Including self - temperature rise)
- Isat for Inductance drop 35% from its value with current
- Measure Equipment :
 - L : Agilent/ E4980 or HP4284A (under 1MHz), HP4285A (over 1MHz)
 - RDC : Chroma 16502
 - Isat : HP4284+42841A or WK3260B+WK3265B

Please be sure to request approval specifications that provide further details of the products. Kindly note that the content of these specifications are subject to change or may be discontinued without prior notice. This product may not be designed/used in medical or high risk applications without Chilisin approval. Please contact our sales department before ordering.

SMD Shielded Power Inductors – BPSC Series

Electrical Characteristics

| Part Number | Inductance (μ H) | Tolerance (\pm %) | Test Frequency | RDC (Ω) Max | Isat(A) Max(Typ.) | Marking |
|--------------------|--------------------------|-------------------------|-------------------|-------------------------|----------------------|---------|
| BPSC001313801R5□00 | 1.5 | 30 | 100 kHz, 1 V | 0.0074 | 21.6(28.0) | 1R5 |
| BPSC001313802R2□00 | 2.2 | 30,+40-20 | 100 kHz, 1 V | 0.0089 | 17.6(24.0) | 2R2 |
| BPSC001313802R4□00 | 2.4 | 30,+40-20 | 100 kHz, 1 V | 0.0089 | 17.6(24.0) | 2R4 |
| BPSC001313803R3□00 | 3.3 | 30,+40-20 | 100 kHz, 1 V | 0.0099 | 14.6(19.4) | 3R3 |
| BPSC001313803R5□00 | 3.5 | 30,+40-20 | 100 kHz, 1 V | 0.0123 | 13.8(17.4) | 3R5 |
| BPSC001313804R7□00 | 4.7 | 20,30 | 100 kHz, 1 V | 0.0158 | 12.3(15.4) | 4R7 |
| BPSC001313806R1□00 | 6.1 | 20,30,+40-20 | 100 kHz, 1 V | 0.0176 | 10.9(13.8) | 6R1 |
| BPSC001313806R8□00 | 6.8 | 20,30 | 100 kHz, 1 V | 0.018 | 10.8(13.7) | 6R8 |
| BPSC001313807R6□00 | 7.6 | 20,30 | 100 kHz, 1 V | 0.02 | 10.0(12.6) | 7R6 |
| BPSC00131380100□00 | 10 | 20,30 | 1 kHz, 1 V | 0.022 | 8.9(11.2) | 100 |
| BPSC00131380120□00 | 12 | 20,30 | 1 kHz, 1 V | 0.03 | 7.4(9.4) | 120 |
| BPSC00131380150□00 | 15 | 20,30 | 1 kHz, 1 V | 0.034 | 7.1(9.0) | 150 |
| BPSC00131380180□00 | 18 | 20,30 | 1 kHz, 1 V | 0.0392 | 6.5(8.2) | 180 |
| BPSC00131380220□00 | 22 | 20,30 | 1 kHz, 1 V | 0.048 | 5.8(7.5) | 220 |
| BPSC00131380270□00 | 27 | 20,30 | 1 kHz, 1 V | 0.052 | 5.3(6.7) | 270 |
| BPSC00131380330□00 | 33 | 20,30 | 1 kHz, 1 V | 0.0648 | 4.8(6.1) | 330 |
| BPSC00131380390□00 | 39 | 20,30 | 1 kHz, 1 V | 0.065 | 3.9(5.6) | 390 |
| BPSC00131380470□00 | 47 | 20,30 | 1 kHz, 1 V | 0.1 | 3.6(5.2) | 470 |
| BPSC00131380560□00 | 56 | 20,30 | 1 kHz, 1 V | 0.11 | 3.4(4.8) | 560 |
| BPSC00131380680□00 | 68 | 20,30 | 1 kHz, 1 V | 0.12 | 2.8(4.1) | 680 |
| BPSC00131380820□00 | 82 | 20,30 | 1 kHz, 1 V | 0.16 | 2.7(4.0) | 820 |
| BPSC00131380101□00 | 100 | 20,30 | 1 kHz, 1 V | 0.17 | 2.5(3.5) | 101 |
| BPSC00131380121□00 | 120 | 20,30 | 1 kHz, 1 V | 0.19 | 2.2(3.2) | 121 |
| BPSC00131380151□00 | 150 | 20,30 | 1 kHz, 1 V | 0.25 | 2.0(2.9) | 151 |
| BPSC00131380181□00 | 180 | 20,30 | 1 kHz, 1 V | 0.31 | 1.8(2.6) | 181 |
| BPSC00131380221□00 | 220 | 20,30 | 1 kHz, 1 V | 0.35 | 1.7(2.4) | 221 |
| BPSC00131380271□00 | 270 | 20,30 | 1 kHz, 1 V | 0.43 | 1.5(2.2) | 271 |
| BPSC00131380331□00 | 330 | 20,30 | 1 kHz, 1 V | 0.51 | 1.2(2.0) | 331 |
| BPSC00131380391□00 | 390 | 20,30 | 1 kHz, 1 V | 0.6 | 1.1(1.6) | 391 |
| BPSC00131380471□00 | 470 | 20,30 | 1 kHz, 1 V | 0.71 | 0.99(1.6) | 471 |
| BPSC00131380561□00 | 560 | 20,30 | 1 kHz, 1 V | 0.88 | 0.95(1.4) | 561 |
| BPSC00131380681□00 | 680 | 20,30 | 1 kHz, 1 V | 1.04 | 0.84(1.2) | 681 |
| BPSC00131380821□00 | 820 | 20,30 | 1 kHz, 1 V | 1.36 | 0.77(1.1) | 821 |
| BPSC00131380102□00 | 1000 | 20,30 | 1 kHz, 1 V | 1.66 | 0.73(1.0) | 102 |

Note: When ordering, please specify tolerance code. Tolerance: M= \pm 20% , T= \pm 30% , N= \pm 40% -20%

- Operating temperature range - 40°C ~ 125°C(Including self - temperature rise)
- Isat for Inductance drop 35% from its value with current
- Measure Equipment :
L : Agilent/ E4980 or HP4284A (under 1MHz), HP4285A (over 1MHz)
RDC : Chroma 16502
Isat : HP4284+42841A or WK3260B+WK3265B

Please be sure to request approval specifications that provide further details of the products. Kindly note that the content of these specifications are subject to change or may be discontinued without prior notice. This product may not be designed/used in medical or high risk applications without Chilisin approval. Please contact our sales department before ordering.

SMD Shielded Power Inductors - BPSC Series

Curves of BPSC Series

Test Instruments : HP4294 Impedance / Material Analyzer

BPSC00070734

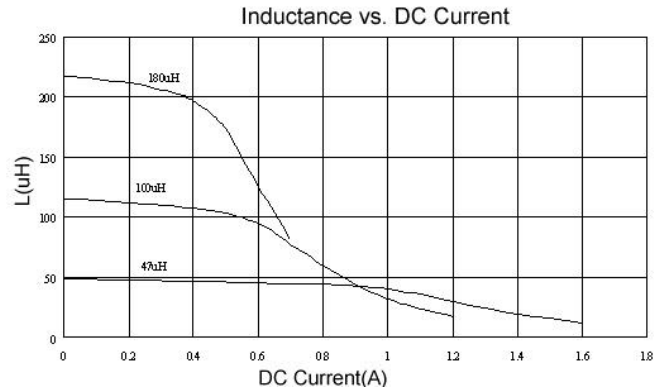
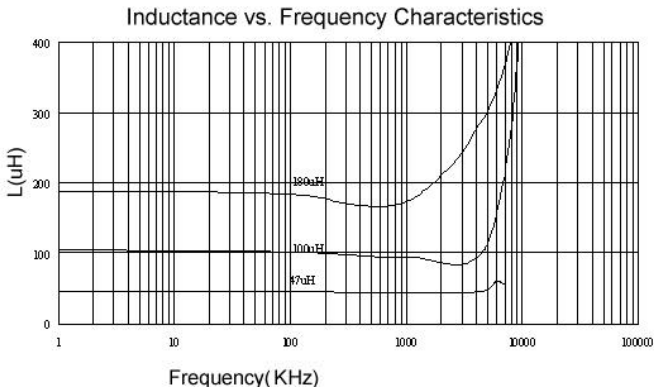

BPSC00070745

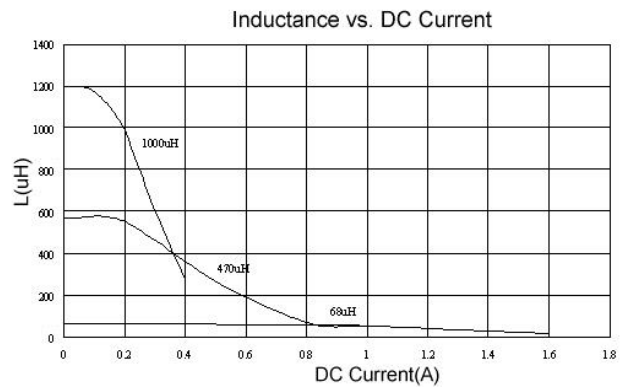
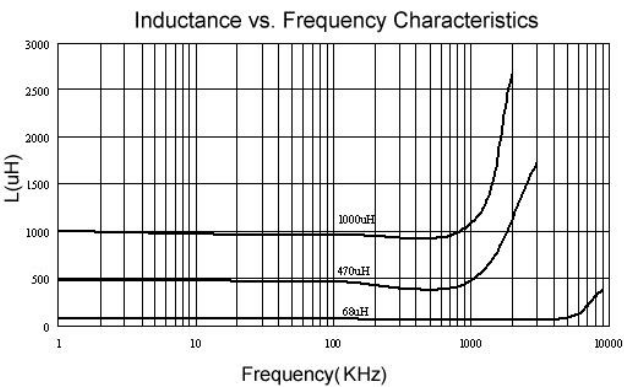

BPSC00101140

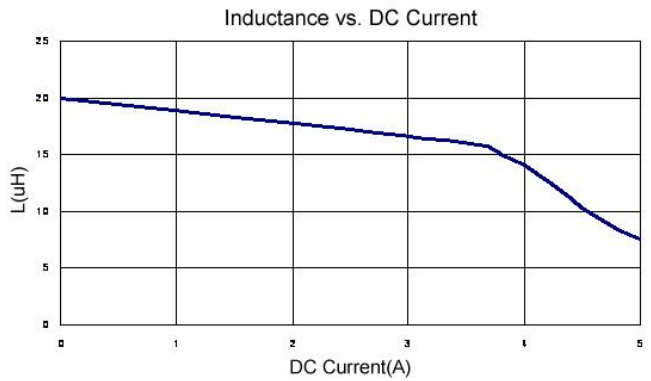
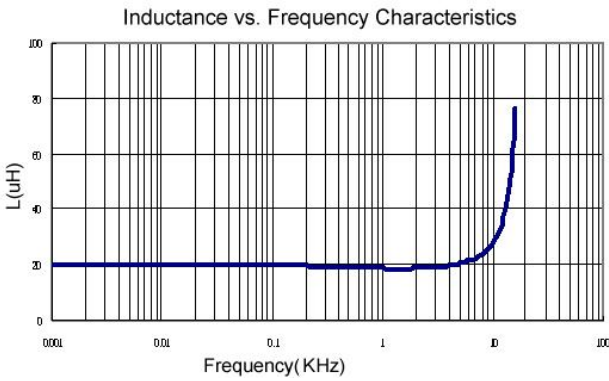

BPSC00131345

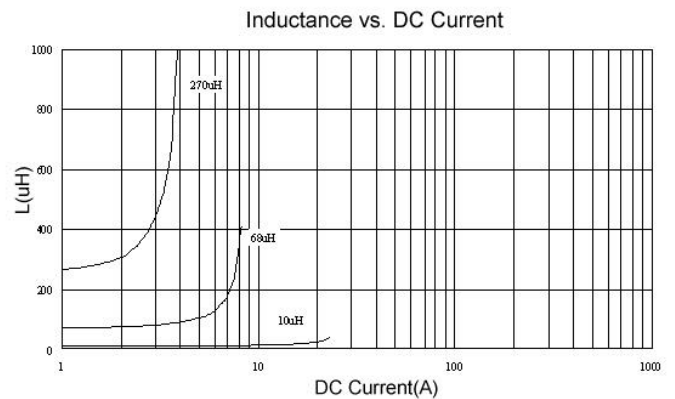
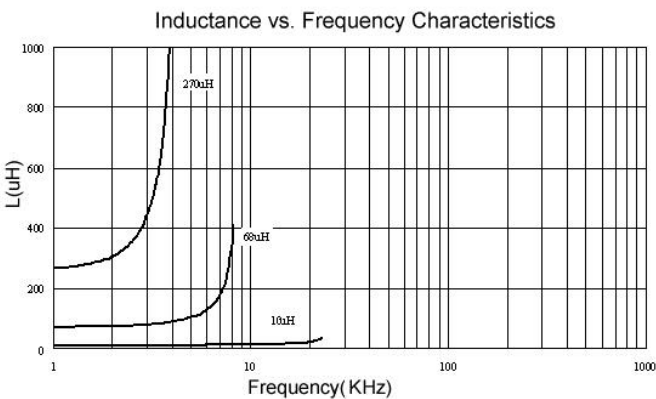

Please be sure to request approval specifications that provide further details of the products. Kindly note that the content of these specifications are subject to change or may be discontinued without prior notice. This product may not be designed/used in medical or high risk applications without Chilisin approval. Please contact our sales department before ordering.

SMD Shielded Power Inductors - BPSC Series

BPSC00131360

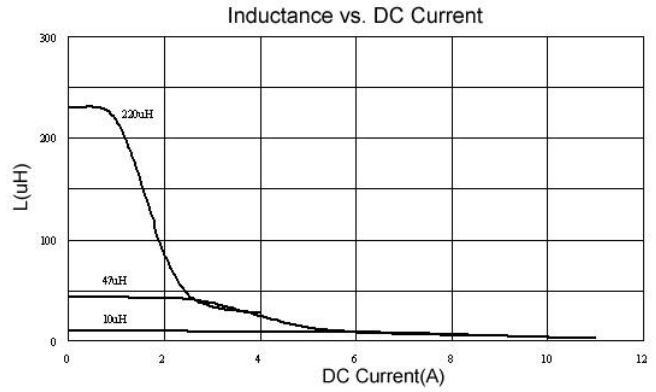
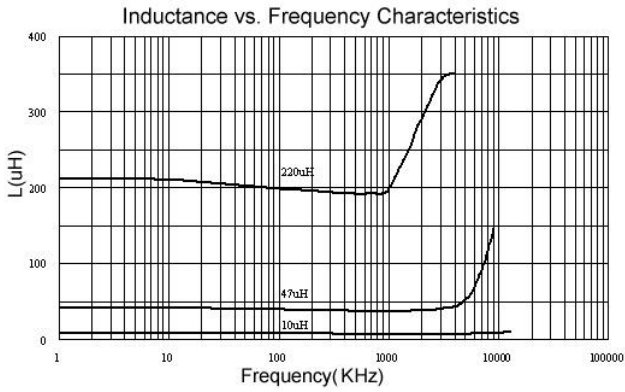

BPSC00131380

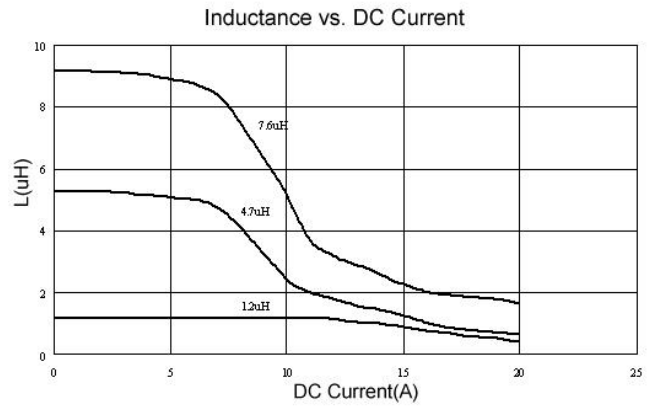
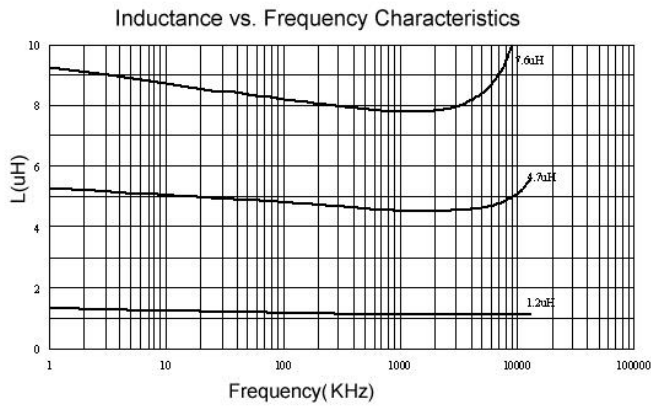

Please be sure to request approval specifications that provide further details of the products. Kindly note that the content of these specifications are subject to change or may be discontinued without prior notice. This product may not be designed/used in medical or high risk applications without Chilisin approval. Please contact our sales department before ordering.

SMD Shielded Power Inductors - BPSC Series

Packaging Specifications

Tape Dimensions

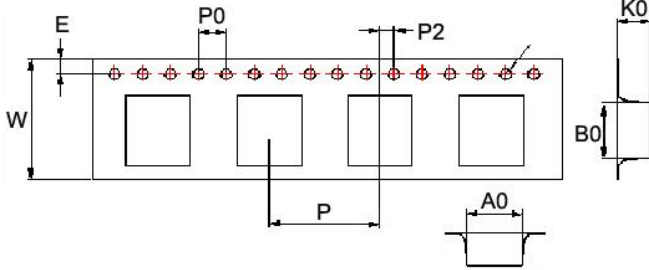

Tape Material

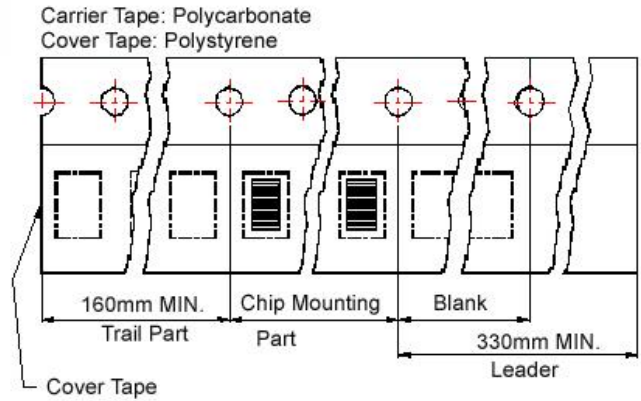

Reel Dimensions

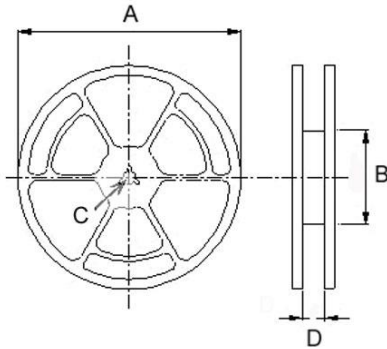

Dimensions in mm

| TYPE | Tape Dimensions | | | | | | | | | Reel Dimensions | | | | Quantity |
|--------------|-----------------|-------|-----|------|------|----|----|----|----|-----------------|-----|----|------|------------|
| | A0 | B0 | K0 | D | E | W | P | P0 | P2 | A | B | C | D | PCS / REEL |
| BPSC00070734 | 7.6 | 7.6 | 3.6 | 1.55 | 1.75 | 16 | 12 | 4 | 2 | 330 | 100 | 13 | 16.0 | 1600 |
| BPSC00070745 | 7.6 | 7.6 | 5.0 | 1.55 | 1.75 | 16 | 12 | 4 | 2 | 330 | 100 | 13 | 16.0 | 1000 |
| BPSC00101131 | 10.6 | 10.75 | 4.2 | 1.55 | 1.75 | 24 | 16 | 4 | 2 | 300 | 100 | 13 | 24.4 | 1000 |
| BPSC00101140 | 10.6 | 10.75 | 4.2 | 1.5 | 1.75 | 24 | 16 | 4 | 2 | 330 | 100 | 13 | 24.4 | 1000 |
| BPSC00101151 | 10.6 | 10.6 | 5.0 | 1.5 | 1.75 | 24 | 16 | 4 | 2 | 330 | 100 | 13 | 24.4 | 500 |
| BPSC00131345 | 13.0 | 12.8 | 5.1 | 1.55 | 1.75 | 24 | 16 | 4 | 2 | 330 | 100 | 13 | 24.4 | 500 |
| BPSC00131360 | 12.6 | 12.6 | 6.7 | 1.55 | 1.75 | 24 | 16 | 4 | 2 | 330 | 100 | 13 | 24.4 | 600 |
| BPSC00131380 | 12.6 | 12.6 | 8.7 | 1.55 | 1.75 | 24 | 16 | 4 | 2 | 330 | 100 | 13 | 24.4 | 500 |

BPSC Series



Features

- RoHS, Halogen Free and REACH Compliance
- Magnetic shielded
- Various package size and wide inductance range

Applications

- AP Routers
- STBs
- LCD TVs and monitors
- Game consoles
- LED lightings
- DC/DC converters

Product Identification

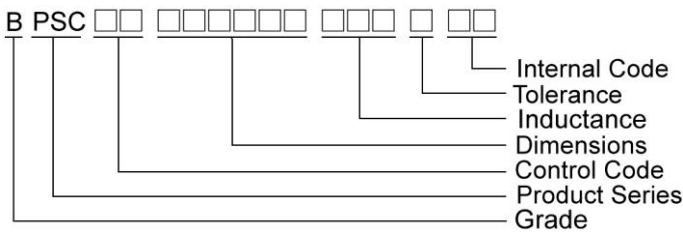

Shapes and Dimensions

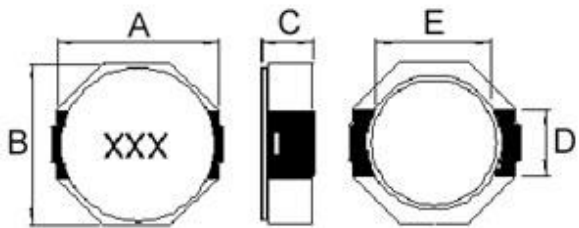

Recommended Pattern

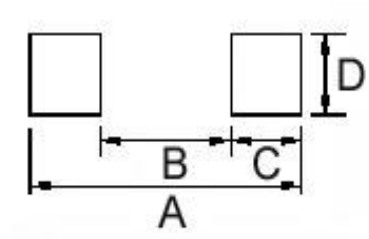

Dimension in mm

| TYPE | A | B | C | D | E |
|--------------|-------------------|-------------------|-------------------|-----|-----|
| BPSC00080845 | 8.3 ⁺⁰ | 8.3 ⁺⁰ | 4.5 ⁺⁰ | 2.5 | 6.3 |

Dimension in mm

| TYPE | A | B | C | D |
|--------------|------|-----|-----|-----|
| BPSC00080845 | 10.1 | 6.1 | 2.0 | 2.8 |

SMD Shielded Power Inductors – BPSC Series

Electrical Characteristics

| Part Number | Inductance (μ H) | Tolerance ($\pm\%$) | Test Frequency (kHz) | RDC ($m\Omega$) Max | Rated Current (A) | Marking |
|--------------------|--------------------------|--------------------------|----------------------------|--------------------------|----------------------|---------|
| BPSC000808453R3□00 | 3.3 | 20 | 100 | 19 | 5.7 | 3R3 |
| BPSC000808454R7□00 | 4.7 | 20 | 100 | 22 | 5.6 | 4R7 |
| BPSC000808456R8□00 | 6.8 | 20 | 100 | 25 | 4.4 | 6R8 |
| BPSC00080845100□00 | 10 | 20 | 100 | 36 | 4.0 | 100 |
| BPSC00080845150□00 | 15 | 20 | 100 | 53 | 2.9 | 150 |
| BPSC00080845220□00 | 22 | 20 | 100 | 75 | 2.4 | 220 |
| BPSC00080845470□00 | 47 | 20 | 100 | 150 | 1.8 | 470 |
| BPSC00080845680□00 | 68 | 20 | 100 | 240 | 1.5 | 680 |
| BPSC00080845101□00 | 100 | 20 | 100 | 353 | 1.1 | 101 |

Note: When ordering, please specify tolerance code. Tolerance: M= \pm 20%

- Operating temperature range - 30°C ~ 100°C(Including self - temperature rise)
- Rated current for Inductance drop 35% from its value with current
- Measure Equipment :
 - L : HP4284A 100kHz/1V
 - RDC : Chroma 16502
 - Rated current : HP4284+42841A

SMD Shielded Power Inductors – BPSC Series

Packaging Specifications

Tape Dimensions

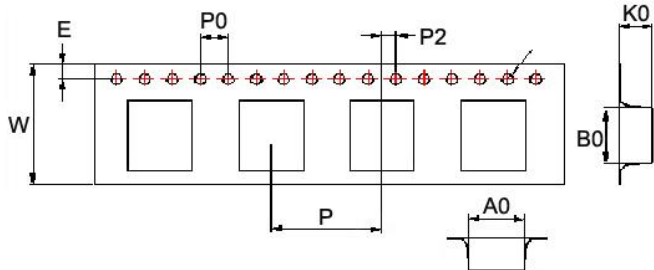

Tape Material

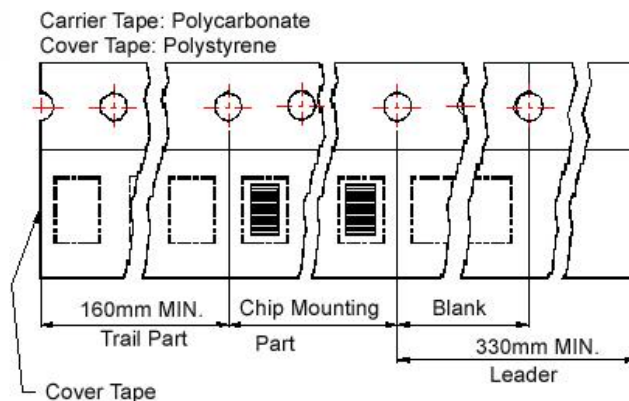

Reel Dimensions

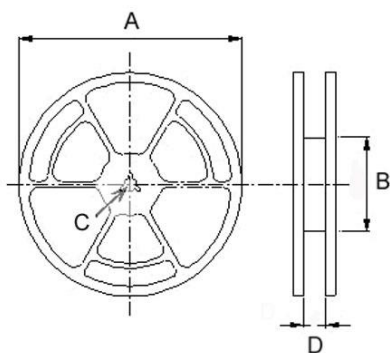

Dimensions in mm

| TYPE | Tape Dimensions | | | | | | | | | Reel Dimensions | | | | Quantity |
|--------------|-----------------|-----|-----|------|------|----|----|----|----|-----------------|-----|----|------|------------|
| | A0 | B0 | K0 | D | E | W | P | P0 | P2 | A | B | C | D | PCS / REEL |
| BPSC00080845 | 8.4 | 9.9 | 4.8 | 1.55 | 1.75 | 24 | 12 | 4 | 2 | 330 | 100 | 13 | 24.4 | 1000 |

单击下面可查看定价，库存，交付和生命周期等信息

[>>CHILISIN\(奇力新\)](#)