

### GENERAL DESCRIPTION

The SGM2036S is a low input voltage, low noise and low dropout voltage linear regulator. It is capable of supplying 300mA output current with typical dropout voltage of only 190mV. The operating input voltage range is from 1.6V to 5.5V. The output voltage range is from 0.75V to 5.0V in fixed output version. For adjustable output version, the output voltage can be adjusted from 0.8V to 5.0V by using external resistors.

Other features include logic-controlled shutdown mode, short-circuit current limit and thermal shutdown protection. The SGM2036S has automatic discharge function to quickly discharge  $V_{OUT}$  in the disabled status.

The SGM2036S is available in Green XTDFN-1×1-4L, SOT-23-5 and SC70-5 packages. It operates over an operating temperature range of -40°C to +125°C.

### FEATURES

- **Operating Input Voltage Range: 1.6V to 5.5V**
- **Fixed Outputs of 0.75V, 0.8V, 0.9V, 1.0V, 1.05V, 1.1V, 1.2V, 1.3V, 1.35V, 1.5V, 1.6V, 1.8V, 1.85V, 2.1V, 2.5V, 2.8V, 2.9V, 3.0V, 3.3V, 3.6V, 4.4V and 5.0V**
- **Adjustable Output from 0.8V to 5.0V**
- **300mA Output Current**
- **Low Supply Pin Current: 30μA (TYP)**
- **Low Dropout Voltage: 190mV (TYP) at 300mA,  $V_{OUT} = 3.0V$**
- **Current Limiting and Thermal Protection**
- **Excellent Load and Line Transient Responses**
- **With Output Automatic Discharge**
- **Stable with Small Case Size Ceramic Capacitors**
- **Short Start-Up Time**
- **Shutdown Supply Current: 0.05μA (TYP)**
- **-40°C to +125°C Operating Temperature Range**
- **Available in Green XTDFN-1×1-4L, SOT-23-5 and SC70-5 Packages**

### APPLICATIONS

Modems  
Cellular Telephones  
PCMCIA Cards  
Palmtop Computers  
Portable Electronics

## PACKAGE/ORDERING INFORMATION

MODEL	PACKAGE DESCRIPTION	SPECIFIED TEMPERATURE RANGE	ORDERING NUMBER	PACKAGE MARKING	PACKING OPTION
SGM2036S-0.75	SOT-23-5	-40°C to +125°C	SGM2036S-0.75XN5G/TR	04EXX	Tape and Reel, 3000
SGM2036S-0.8	SOT-23-5	-40°C to +125°C	SGM2036S-0.8XN5G/TR	G6ZXX	Tape and Reel, 3000
SGM2036S-0.9	SOT-23-5	-40°C to +125°C	SGM2036S-0.9XN5G/TR	G78XX	Tape and Reel, 3000
SGM2036S-1.0	SOT-23-5	-40°C to +125°C	SGM2036S-1.0XN5G/TR	G7GXX	Tape and Reel, 3000
SGM2036S-1.05	SOT-23-5	-40°C to +125°C	SGM2036S-1.05XN5G/TR	G7HXX	Tape and Reel, 3000
SGM2036S-1.1	SOT-23-5	-40°C to +125°C	SGM2036S-1.1XN5G/TR	G7IXX	Tape and Reel, 3000
SGM2036S-1.2	SOT-23-5	-40°C to +125°C	SGM2036S-1.2XN5G/TR	G7JXX	Tape and Reel, 3000
SGM2036S-1.3	SOT-23-5	-40°C to +125°C	SGM2036S-1.3XN5G/TR	G7KXX	Tape and Reel, 3000
SGM2036S-1.5	SOT-23-5	-40°C to +125°C	SGM2036S-1.5XN5G/TR	G7LXX	Tape and Reel, 3000
SGM2036S-1.8	SOT-23-5	-40°C to +125°C	SGM2036S-1.8XN5G/TR	G7MXX	Tape and Reel, 3000
SGM2036S-1.85	SOT-23-5	-40°C to +125°C	SGM2036S-1.85XN5G/TR	G7NXX	Tape and Reel, 3000
SGM2036S-2.1	SOT-23-5	-40°C to +125°C	SGM2036S-2.1XN5G/TR	G7PXX	Tape and Reel, 3000
SGM2036S-2.5	SOT-23-5	-40°C to +125°C	SGM2036S-2.5XN5G/TR	G7SXX	Tape and Reel, 3000
SGM2036S-2.8	SOT-23-5	-40°C to +125°C	SGM2036S-2.8XN5G/TR	G7VXX	Tape and Reel, 3000
SGM2036S-2.9	SOT-23-5	-40°C to +125°C	SGM2036S-2.9XN5G/TR	G7XXX	Tape and Reel, 3000
SGM2036S-3.0	SOT-23-5	-40°C to +125°C	SGM2036S-3.0XN5G/TR	G7YXX	Tape and Reel, 3000
SGM2036S-3.3	SOT-23-5	-40°C to +125°C	SGM2036S-3.3XN5G/TR	G8EXX	Tape and Reel, 3000
SGM2036S-3.6	SOT-23-5	-40°C to +125°C	SGM2036S-3.6XN5G/TR	G8GXX	Tape and Reel, 3000
SGM2036S-4.4	SOT-23-5	-40°C to +125°C	SGM2036S-4.4XN5G/TR	G8IXX	Tape and Reel, 3000
SGM2036S-5.0	SOT-23-5	-40°C to +125°C	SGM2036S-5.0XN5G/TR	G8JXX	Tape and Reel, 3000
SGM2036S-ADJ	SOT-23-5	-40°C to +125°C	SGM2036S-ADJXN5G/TR	G5QXX	Tape and Reel, 3000

## PACKAGE/ORDERING INFORMATION (continued)

MODEL	PACKAGE DESCRIPTION	SPECIFIED TEMPERATURE RANGE	ORDERING NUMBER	PACKAGE MARKING	PACKING OPTION
SGM2036S-0.8	SC70-5	-40°C to +125°C	SGM2036S-0.8XC5G/TR	G8KXX	Tape and Reel, 3000
SGM2036S-0.9	SC70-5	-40°C to +125°C	SGM2036S-0.9XC5G/TR	G8LXX	Tape and Reel, 3000
SGM2036S-1.0	SC70-5	-40°C to +125°C	SGM2036S-1.0XC5G/TR	G8MXX	Tape and Reel, 3000
SGM2036S-1.05	SC70-5	-40°C to +125°C	SGM2036S-1.05XC5G/TR	G8NXX	Tape and Reel, 3000
SGM2036S-1.1	SC70-5	-40°C to +125°C	SGM2036S-1.1XC5G/TR	G8PXX	Tape and Reel, 3000
SGM2036S-1.2	SC70-5	-40°C to +125°C	SGM2036S-1.2XC5G/TR	G8QXX	Tape and Reel, 3000
SGM2036S-1.3	SC70-5	-40°C to +125°C	SGM2036S-1.3XC5G/TR	G8RXX	Tape and Reel, 3000
SGM2036S-1.5	SC70-5	-40°C to +125°C	SGM2036S-1.5XC5G/TR	G8SXX	Tape and Reel, 3000
SGM2036S-1.8	SC70-5	-40°C to +125°C	SGM2036S-1.8XC5G/TR	G8TXX	Tape and Reel, 3000
SGM2036S-1.85	SC70-5	-40°C to +125°C	SGM2036S-1.85XC5G/TR	G8UXX	Tape and Reel, 3000
SGM2036S-2.1	SC70-5	-40°C to +125°C	SGM2036S-2.1XC5G/TR	G8VXX	Tape and Reel, 3000
SGM2036S-2.5	SC70-5	-40°C to +125°C	SGM2036S-2.5XC5G/TR	G8YXX	Tape and Reel, 3000
SGM2036S-2.8	SC70-5	-40°C to +125°C	SGM2036S-2.8XC5G/TR	G9HXX	Tape and Reel, 3000
SGM2036S-2.9	SC70-5	-40°C to +125°C	SGM2036S-2.9XC5G/TR	G9JXX	Tape and Reel, 3000
SGM2036S-3.0	SC70-5	-40°C to +125°C	SGM2036S-3.0XC5G/TR	G9KXX	Tape and Reel, 3000
SGM2036S-3.3	SC70-5	-40°C to +125°C	SGM2036S-3.3XC5G/TR	G9MXX	Tape and Reel, 3000
SGM2036S-3.6	SC70-5	-40°C to +125°C	SGM2036S-3.6XC5G/TR	G9NXX	Tape and Reel, 3000
SGM2036S-4.4	SC70-5	-40°C to +125°C	SGM2036S-4.4XC5G/TR	G9QXX	Tape and Reel, 3000
SGM2036S-5.0	SC70-5	-40°C to +125°C	SGM2036S-5.0XC5G/TR	G9RXX	Tape and Reel, 3000
SGM2036S-ADJ	SC70-5	-40°C to +125°C	SGM2036S-ADJXC5G/TR	G5PXX	Tape and Reel, 3000

## PACKAGE/ORDERING INFORMATION (continued)

MODEL	PACKAGE DESCRIPTION	SPECIFIED TEMPERATURE RANGE	ORDERING NUMBER	PACKAGE MARKING	PACKING OPTION
SGM2036S-0.75	XTDFN-1×1-4L	-40°C to +125°C	SGM2036S-0.75XXDH4G/TR	0D	Tape and Reel, 10000
SGM2036S-0.8	XTDFN-1×1-4L	-40°C to +125°C	SGM2036S-0.8XXDH4G/TR	1Y	Tape and Reel, 10000
SGM2036S-0.9	XTDFN-1×1-4L	-40°C to +125°C	SGM2036S-0.9XXDH4G/TR	3K	Tape and Reel, 10000
SGM2036S-1.0	XTDFN-1×1-4L	-40°C to +125°C	SGM2036S-1.0XXDH4G/TR	3L	Tape and Reel, 10000
SGM2036S-1.05	XTDFN-1×1-4L	-40°C to +125°C	SGM2036S-1.05XXDH4G/TR	3M	Tape and Reel, 10000
SGM2036S-1.1	XTDFN-1×1-4L	-40°C to +125°C	SGM2036S-1.1XXDH4G/TR	3N	Tape and Reel, 10000
SGM2036S-1.2	XTDFN-1×1-4L	-40°C to +125°C	SGM2036S-1.2XXDH4G/TR	3P	Tape and Reel, 10000
SGM2036S-1.3	XTDFN-1×1-4L	-40°C to +125°C	SGM2036S-1.3XXDH4G/TR	3Q	Tape and Reel, 10000
SGM2036S-1.35	XTDFN-1×1-4L	-40°C to +125°C	SGM2036S-1.35XXDH4G/TR	3R	Tape and Reel, 10000
SGM2036S-1.5	XTDFN-1×1-4L	-40°C to +125°C	SGM2036S-1.5XXDH4G/TR	3S	Tape and Reel, 10000
SGM2036S-1.6	XTDFN-1×1-4L	-40°C to +125°C	SGM2036S-1.6XXDH4G/TR	24	Tape and Reel, 10000
SGM2036S-1.8	XTDFN-1×1-4L	-40°C to +125°C	SGM2036S-1.8XXDH4G/TR	3T	Tape and Reel, 10000
SGM2036S-1.85	XTDFN-1×1-4L	-40°C to +125°C	SGM2036S-1.85XXDH4G/TR	3U	Tape and Reel, 10000
SGM2036S-2.1	XTDFN-1×1-4L	-40°C to +125°C	SGM2036S-2.1XXDH4G/TR	3V	Tape and Reel, 10000
SGM2036S-2.5	XTDFN-1×1-4L	-40°C to +125°C	SGM2036S-2.5XXDH4G/TR	3Y	Tape and Reel, 10000
SGM2036S-2.8	XTDFN-1×1-4L	-40°C to +125°C	SGM2036S-2.8XXDH4G/TR	4D	Tape and Reel, 10000
SGM2036S-2.9	XTDFN-1×1-4L	-40°C to +125°C	SGM2036S-2.9XXDH4G/TR	4H	Tape and Reel, 10000
SGM2036S-3.0	XTDFN-1×1-4L	-40°C to +125°C	SGM2036S-3.0XXDH4G/TR	4I	Tape and Reel, 10000
SGM2036S-3.3	XTDFN-1×1-4L	-40°C to +125°C	SGM2036S-3.3XXDH4G/TR	4J	Tape and Reel, 10000
SGM2036S-3.6	XTDFN-1×1-4L	-40°C to +125°C	SGM2036S-3.6XXDH4G/TR	2D	Tape and Reel, 10000

## MARKING INFORMATION

NOTE: XX = Date Code.

## SOT-23-5/SC70-5

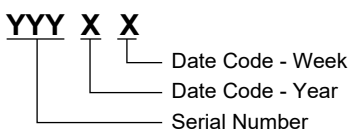
  
 YYY X X
   
 Serial Number
   
 Date Code - Year
   
 Date Code - Week

## XTDFN-1×1-4L

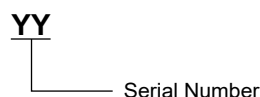
  
 YY
   
 Serial Number

Green (RoHS & HSF): SG Micro Corp defines "Green" to mean Pb-Free (RoHS compatible) and free of halogen substances. If you have additional comments or questions, please contact your SGMICRO representative directly.

**ABSOLUTE MAXIMUM RATINGS**

IN, EN to GND .....	-0.3V to 6V
OUT, BP/FB to GND .....	-0.3V to MIN((V <sub>IN</sub> + 0.3V), 6V)
Power Dissipation, P <sub>D</sub> @ T <sub>A</sub> = +25°C	
XTDFN-1×1-4L .....	0.66W
SOT-23-5 .....	0.7W
SC70-5 .....	0.66W
Package Thermal Resistance	
XTDFN-1×1-4L, θ <sub>JA</sub> .....	187.3°C/W
XTDFN-1×1-4L, θ <sub>JB</sub> .....	133.2°C/W
XTDFN-1×1-4L, θ <sub>JC</sub> .....	150.7°C/W
XTDFN-1×1-4L, θ <sub>JC(BOT)</sub> .....	120.1°C/W
SOT-23-5, θ <sub>JA</sub> .....	178.2°C/W
SOT-23-5, θ <sub>JB</sub> .....	92.6°C/W
SOT-23-5, θ <sub>JC</sub> .....	125°C/W
SC70-5, θ <sub>JA</sub> .....	188°C/W
SC70-5, θ <sub>JB</sub> .....	55.4°C/W
SC70-5, θ <sub>JC</sub> .....	103.2°C/W
Junction Temperature .....	+150°C
Storage Temperature Range .....	-65°C to +150°C
Lead Temperature (Soldering, 10s) .....	+260°C
ESD Susceptibility	
HBM .....	5000V
CDM .....	1000V

**RECOMMENDED OPERATING CONDITIONS**

Operating Input Voltage Range .....	1.6V to 5.5V
Enable Input Voltage Range .....	0V to 5.5V
Input Effective Capacitance, C <sub>IN</sub> .....	0.5μF (MIN)
Output Effective Capacitance, C <sub>OUT</sub> .....	0.5μF to 10μF
Operating Junction Temperature Range .....	-40°C to +125°C

**OVERSTRESS CAUTION**

Stresses beyond those listed in Absolute Maximum Ratings may cause permanent damage to the device. Exposure to absolute maximum rating conditions for extended periods may affect reliability. Functional operation of the device at any conditions beyond those indicated in the Recommended Operating Conditions section is not implied.

**ESD SENSITIVITY CAUTION**

This integrated circuit can be damaged if ESD protections are not considered carefully. SGMICRO recommends that all integrated circuits be handled with appropriate precautions. Failure to observe proper handling and installation procedures can cause damage. ESD damage can range from subtle performance degradation to complete device failure. Precision integrated circuits may be more susceptible to damage because even small parametric changes could cause the device not to meet the published specifications.

**DISCLAIMER**

SG Micro Corp reserves the right to make any change in circuit design, or specifications without prior notice.

PIN CONFIGURATIONS

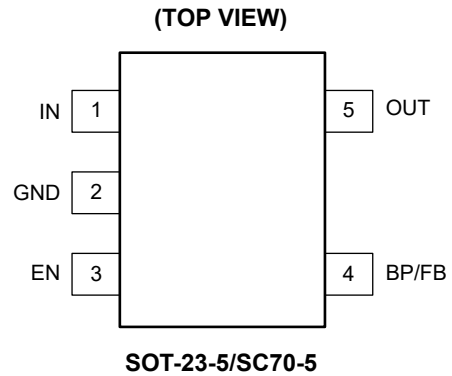
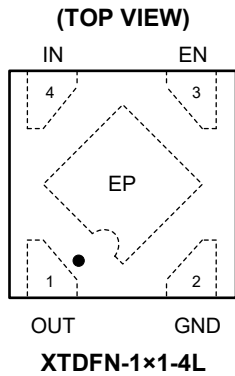

PIN DESCRIPTION

PIN		NAME	FUNCTION
XTDFN-1x1-4L	SOT-23-5/ SC70-5		
1	5	OUT	Regulator Output Pin. It is recommended to use a ceramic capacitor with effective capacitance in the range of 0.5 $\mu$ F to 10 $\mu$ F to ensure stability. This ceramic capacitor should be placed as close as possible to OUT pin.
2	2	GND	Ground.
3	3	EN	Enable Pin. Drive EN high to turn on the regulator. Drive EN low to turn off the regulator. This pin must be pulled high by an external resistor connected to IN pin if EN pin is not used.
4	1	IN	Input Voltage Supply Pin. It is recommended to use a 1 $\mu$ F or larger ceramic capacitor from IN pin to ground to get good power supply decoupling. This ceramic capacitor should be placed as close as possible to IN pin.
-	4	BP	Reference-Noise Bypass Pin (fixed voltage version only). Bypass with an external capacitor $C_{BP}$ can reduce output noise. The capacitor is recommended to be placed very close to the pin for high PSRR. This pin can also be floating.
		FB	Feedback Voltage Input Pin (adjustable voltage version only). Connect this pin to the midpoint of an external resistor divider to adjust the output voltage. Place the resistors as close as possible to this pin.
Exposed Pad	-	-	Exposed Pad. Connect it to a large ground plane to maximize thermal performance. This pad is not an electrical connection point.

FUNCTIONAL BLOCK DIAGRAMS

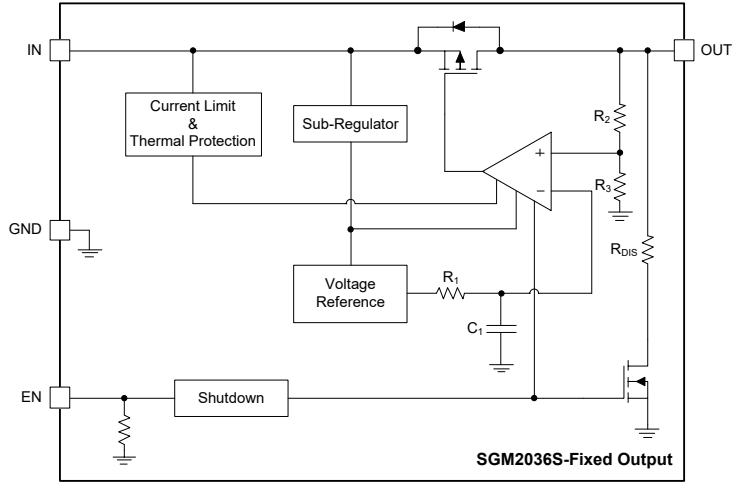

Figure 1. Internal Block Diagram of Fixed Output Voltage (XTDFN-1x1-4L Version)

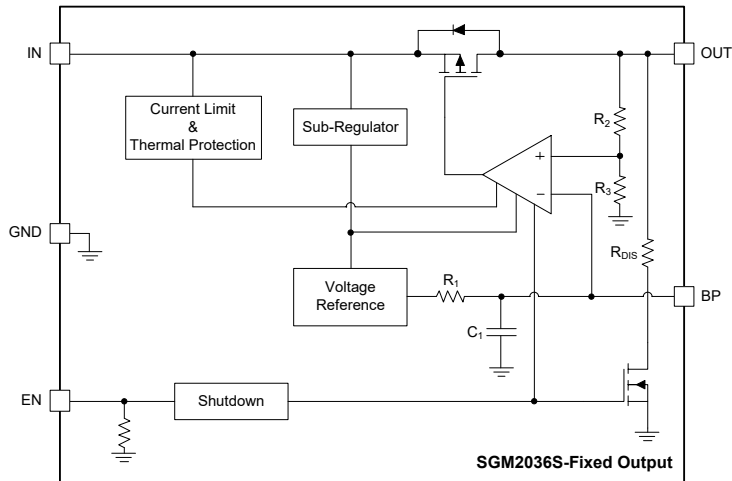

Figure 2. Internal Block Diagram of Fixed Output Voltage (SOT-23-5 and SC70-5 Versions)

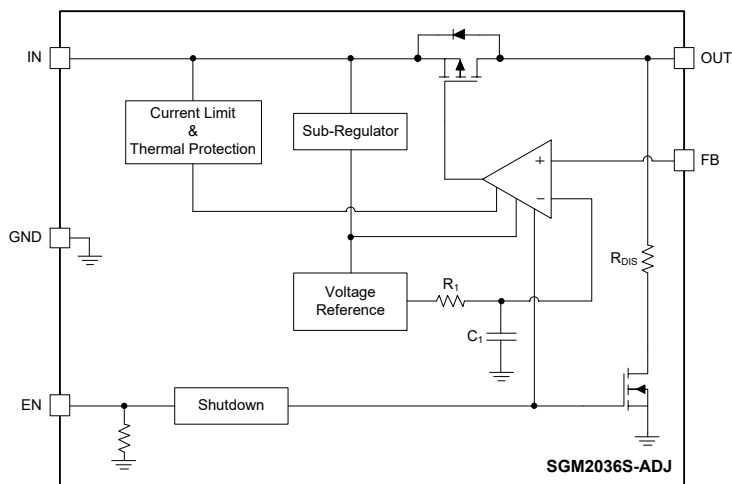

Figure 3. Internal Block Diagram of Adjustable Output Voltage (SOT-23-5 and SC70-5 Versions)

## ELECTRICAL CHARACTERISTICS

( $V_{IN} = (V_{OUT(NOM)} + 0.5V)$  or 2.5V (whichever is greater),  $V_{EN} = V_{IN}$ ,  $T_J = -40^{\circ}C$  to  $+125^{\circ}C$ , typical values are at  $T_J = +25^{\circ}C$ , unless otherwise noted.)

PARAMETER	SYMBOL	CONDITIONS	MIN	TYP	MAX	UNITS	
Input Voltage Range	$V_{IN}$		1.6		5.5	V	
Output Voltage Accuracy	$V_{OUT}$	$I_{OUT} = 0.1mA$ , $T_J = +25^{\circ}C$	-2.5		2.5	%	
Feedback Voltage	$V_{FB}$	$I_{OUT} = 0.1mA$ , SGM2036S-ADJ, $T_J = +25^{\circ}C$	0.78	0.8	0.82	V	
FB Pin Leakage Current	$I_{FB}$	$V_{FB} = 0.9V$		1	100	nA	
Under-Voltage Lockout Thresholds	$V_{UVLO}$	$V_{IN}$ rising		1.5	1.6	V	
		$V_{IN}$ falling		1.3			
Line Regulation	$\frac{\Delta V_{OUT}}{\Delta V_{IN} \times V_{OUT}}$	$V_{IN} = 1.6V$ or ( $V_{OUT(NOM)} + 0.5V$ ) to 5.5V, $I_{OUT} = 0.1mA$ , $T_J = +25^{\circ}C$		0.04	0.1	%/V	
Load Regulation	$\Delta V_{OUT}$	$I_{OUT} = 0.1mA$ to 300mA, $T_J = +25^{\circ}C$		30	45	mV	
		$I_{OUT} = 0.1mA$ to 300mA, SGM2036S-ADJ, $T_J = +25^{\circ}C$		3	10		
Dropout Voltage	$V_{DROP}$	$V_{OUT} = V_{OUT(NOM)} - 100mV$ , $I_{OUT} = 300mA$ , $T_J = +25^{\circ}C$	$V_{OUT(NOM)} = 0.8V$		880	1200	mV
			$V_{OUT(NOM)} = 0.9V$		780	1100	
			$1.0V \leq V_{OUT(NOM)} < 1.1V$		690	1000	
			$1.1V \leq V_{OUT(NOM)} < 1.2V$		640	900	
			$1.2V \leq V_{OUT(NOM)} < 1.5V$		560	800	
			$1.5V \leq V_{OUT(NOM)} < 1.8V$		390	550	
			$1.8V \leq V_{OUT(NOM)} < 2.1V$		320	420	
			$2.1V \leq V_{OUT(NOM)} < 2.5V$		260	340	
			$2.5V \leq V_{OUT(NOM)} < 3.0V$		215	280	
$3.0V \leq V_{OUT(NOM)} \leq 5.0V$		190	250				
Output Current Limit	$I_{LIMIT}$		350	800		mA	
Short-Circuit Current	$I_{SHORT}$	$V_{OUT} = 0V$		380		mA	
Supply Pin Current	$I_Q$	No load, $T_J = +25^{\circ}C$		30	45	$\mu A$	
Shutdown Supply Current	$I_{SHDN}$	$V_{EN} = 0V$		0.05	1	$\mu A$	
EN Input Thresholds	$V_{IH}$	$V_{IN} = 1.6V$ to 5.5V		1.5		V	
	$V_{IL}$						
EN Input Bias Current	$I_{BH}$	$V_{EN} = 5.5V$		0.8	1.5	$\mu A$	
	$I_{BL}$	$V_{EN} = 0V$		0.01	1		
Output Discharge Resistance	$R_{DIS}$	$V_{EN} = 0V$ , $V_{IN} = 4V$ , $V_{OUT} = 0.3V$		75		$\Omega$	
Start-Up Time	$t_{STR}$	$C_{OUT} = 1\mu F$ , $I_{OUT} = 1mA$ , $V_{OUT(NOM)} = 1.8V$ , from assertion of $V_{EN}$ to $V_{OUT} = 90\% \times V_{OUT(NOM)}$		100		$\mu s$	
Power Supply Rejection Ratio	PSRR	$C_{BP} = 0nF$ , $C_{OUT} = 1\mu F$ , $I_{OUT} = 30mA$ , $V_{IN} = 2.8V$ , $V_{OUT(NOM)} = 1.8V$ , $\Delta V_{RIPPLE} = 0.2V_{P-P}$	$f = 217Hz$		82	dB	
			$f = 1kHz$		76		
			$f = 217Hz$		92		
			$f = 1kHz$		86		
Output Voltage Noise	$e_n$	$C_{BP} = 0nF$ , $C_{OUT} = 1\mu F$ , $V_{OUT(NOM)} = 1.8V$ , $f = 10Hz$ to 100kHz	$I_{OUT} = 0mA$		18	$\mu V_{RMS}$	
			$I_{OUT} = 30mA$		100		
			$I_{OUT} = 0mA$		13		
			$I_{OUT} = 30mA$		60		
Thermal Shutdown Temperature	$T_{SHDN}$			160		$^{\circ}C$	
Thermal Shutdown Hysteresis	$\Delta T_{SHDN}$			20		$^{\circ}C$	



TYPICAL PERFORMANCE CHARACTERISTICS

$T_J = +25^\circ\text{C}$ ,  $V_{IN} = (V_{OUT(NOM)} + 0.5\text{V})$  or  $2.5\text{V}$  (whichever is greater),  $V_{EN} = V_{IN}$ ,  $C_{IN} = C_{OUT} = 1\mu\text{F}$ ,  $C_{BP} = 0\text{nF}$ , unless otherwise noted.

Turn On Speed with EN Pin

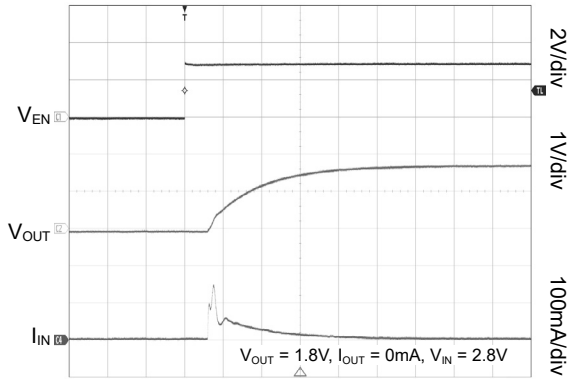

Time (20µs/div)

Turn On Speed with EN Pin

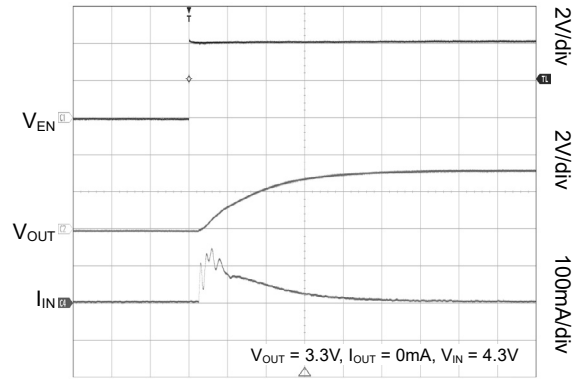

Time (20µs/div)

Turn Off Speed with EN Pin

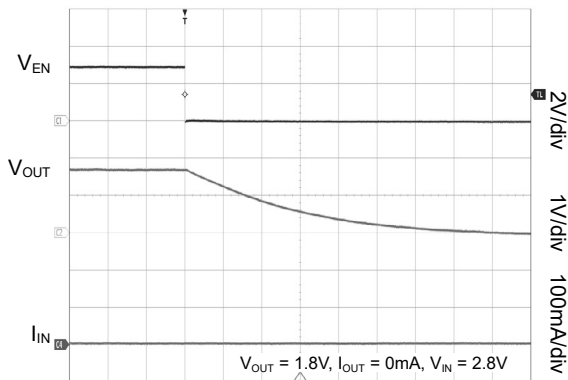

Time (40µs/div)

Turn Off Speed with EN Pin

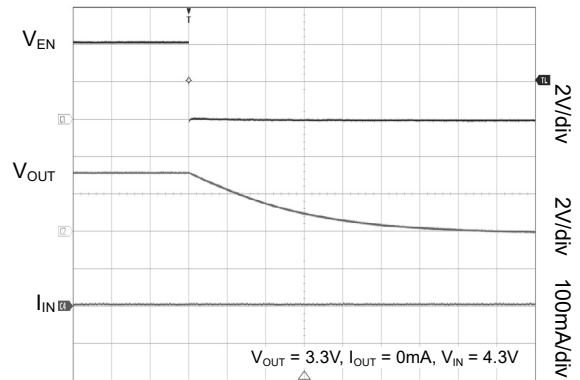

Time (40µs/div)

Line Transient Response

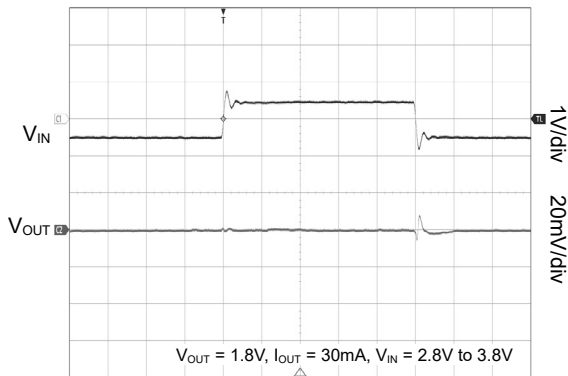

Time (40µs/div)

Line Transient Response

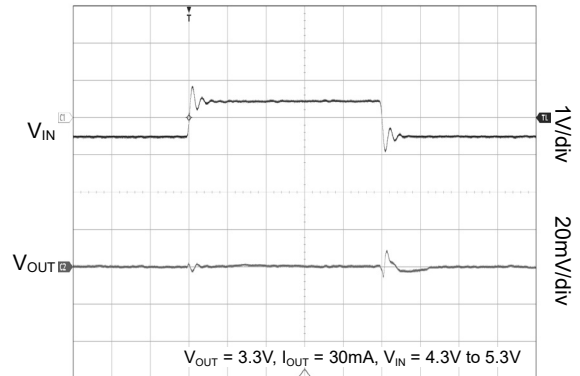

Time (40µs/div)

TYPICAL PERFORMANCE CHARACTERISTICS (continued)

$T_J = +25^\circ\text{C}$ ,  $V_{IN} = (V_{OUT(NOM)} + 0.5\text{V})$  or 2.5V (whichever is greater),  $V_{EN} = V_{IN}$ ,  $C_{IN} = C_{OUT} = 1\mu\text{F}$ ,  $C_{BP} = 0\text{nF}$ , unless otherwise noted.

Load Transient Response

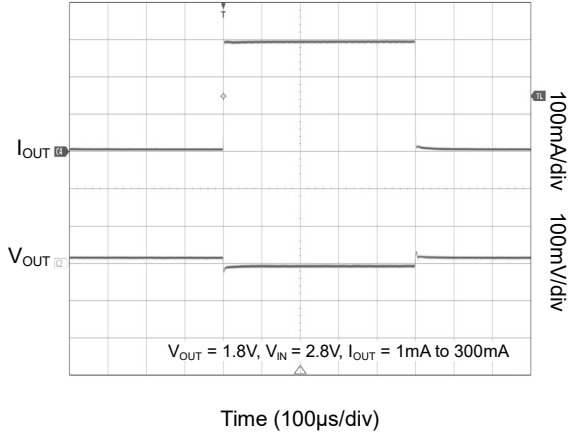

Load Transient Response

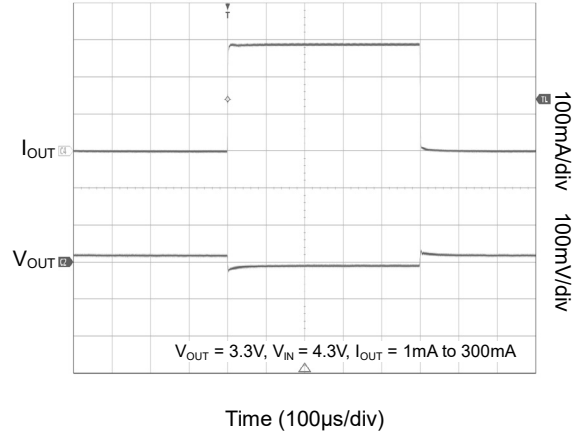

Load Transient Response

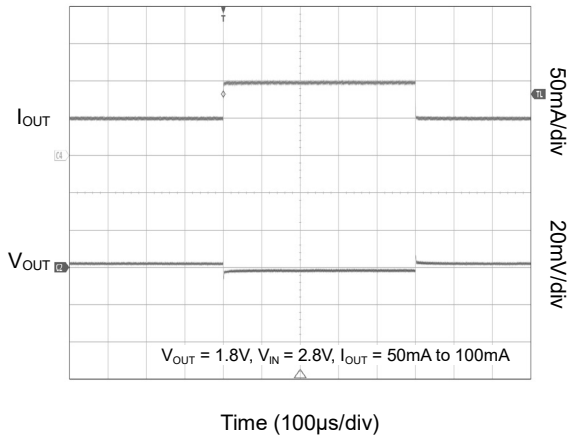

Load Transient Response

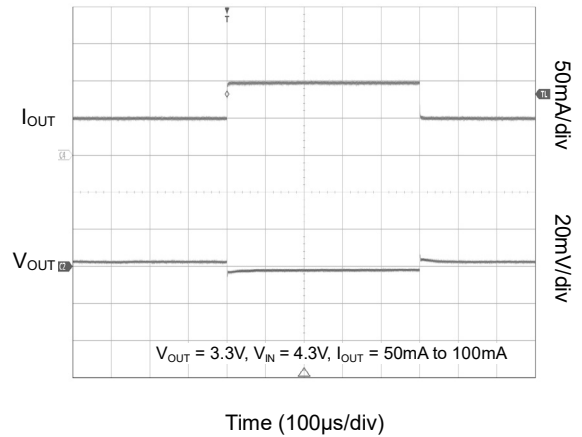

Power Supply Rejection Ratio vs. Frequency

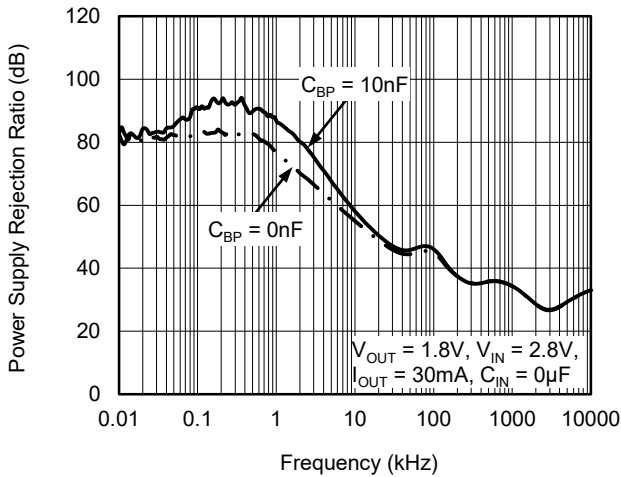

Power Supply Rejection Ratio vs. Frequency

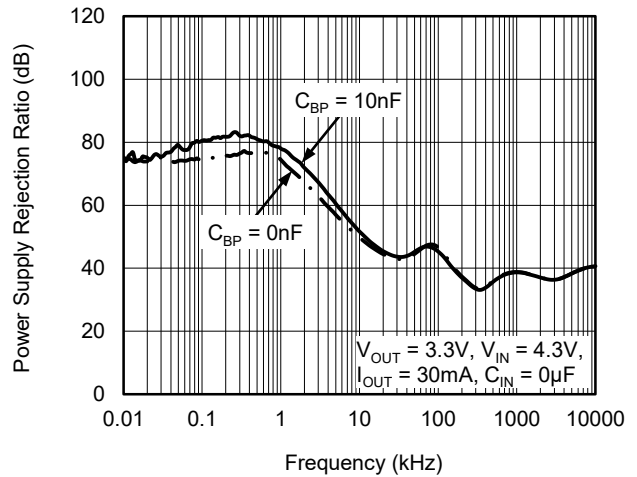

TYPICAL PERFORMANCE CHARACTERISTICS (continued)

$T_J = +25^\circ\text{C}$ ,  $V_{IN} = (V_{OUT(NOM)} + 0.5\text{V})$  or  $2.5\text{V}$  (whichever is greater),  $V_{EN} = V_{IN}$ ,  $C_{IN} = C_{OUT} = 1\mu\text{F}$ ,  $C_{BP} = 0\text{nF}$ , unless otherwise noted.

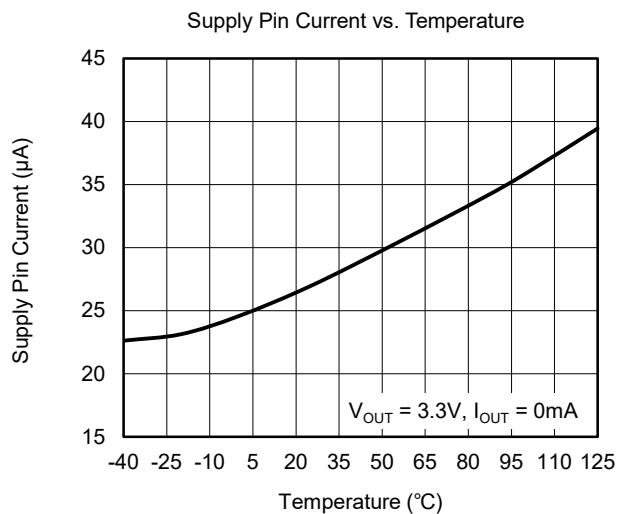
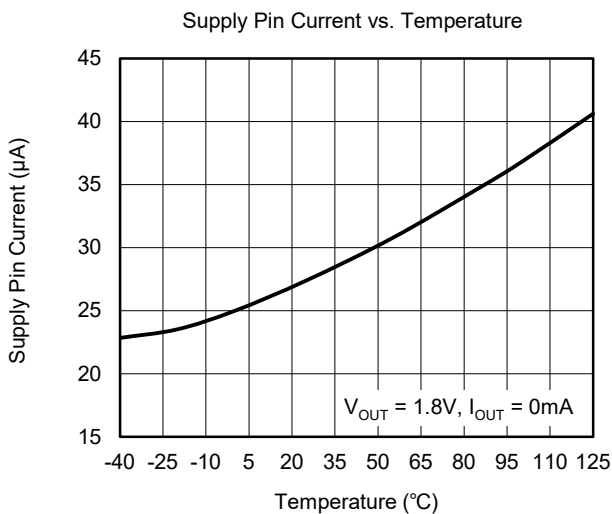
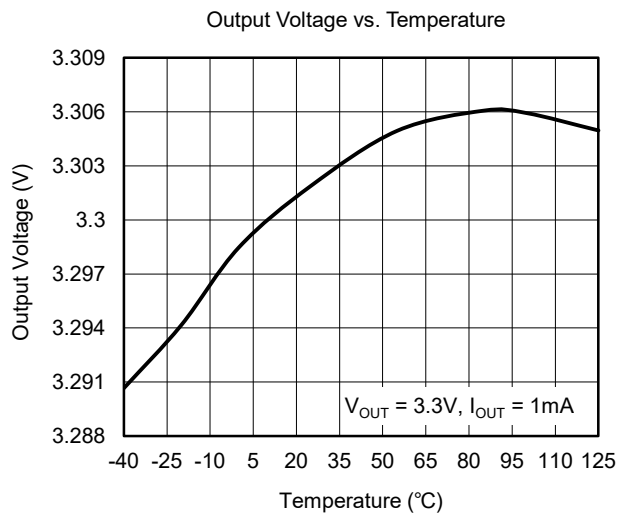
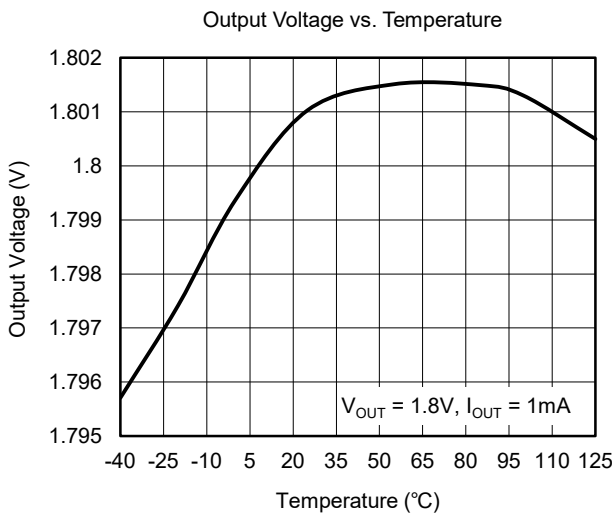
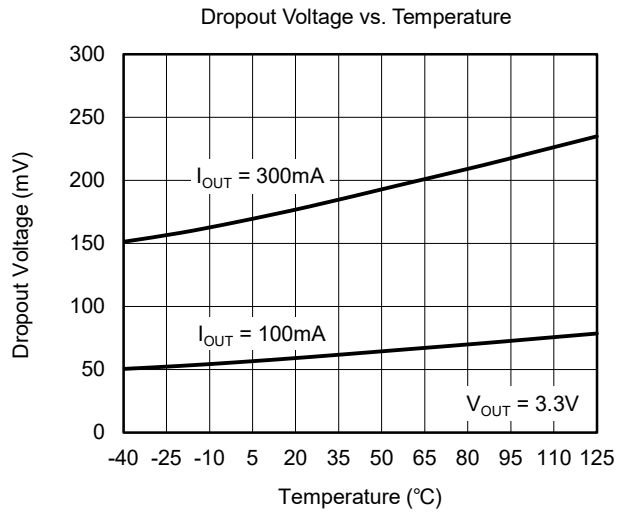
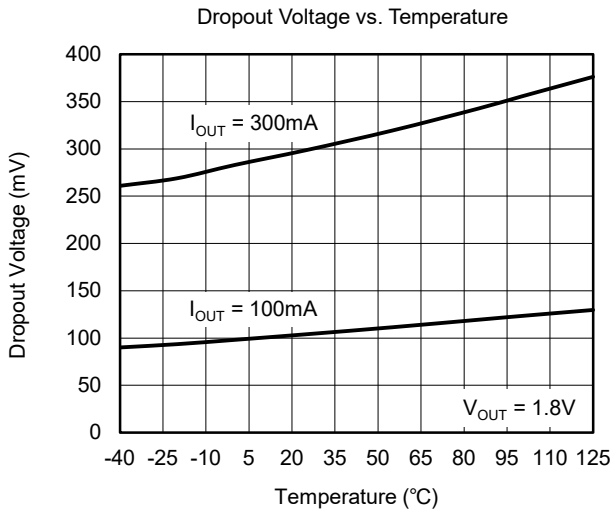

TYPICAL PERFORMANCE CHARACTERISTICS (continued)

$T_J = +25^\circ\text{C}$ ,  $V_{IN} = (V_{OUT(NOM)} + 0.5\text{V})$  or  $2.5\text{V}$  (whichever is greater),  $V_{EN} = V_{IN}$ ,  $C_{IN} = C_{OUT} = 1\mu\text{F}$ ,  $C_{BP} = 0\text{nF}$ , unless otherwise noted.

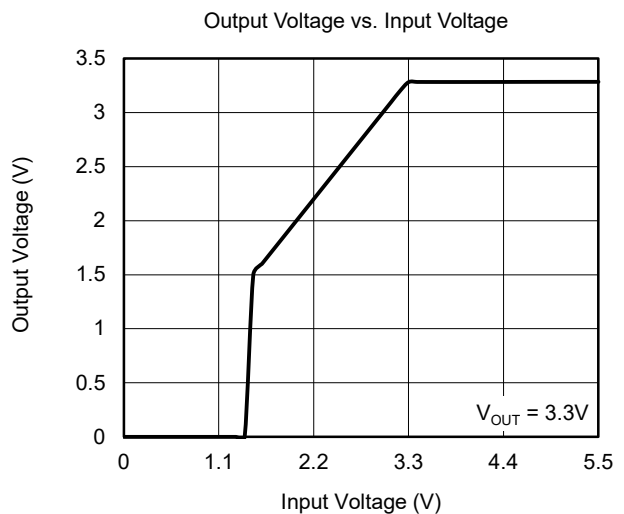
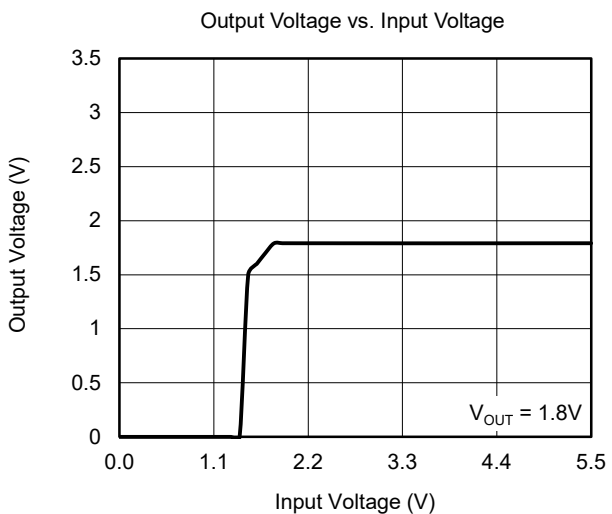
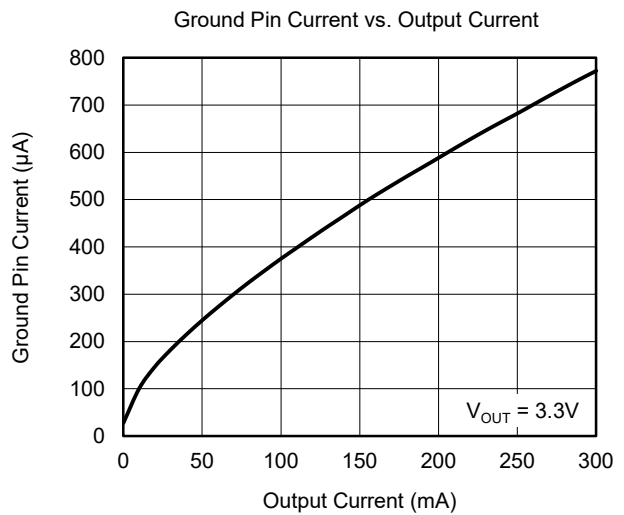
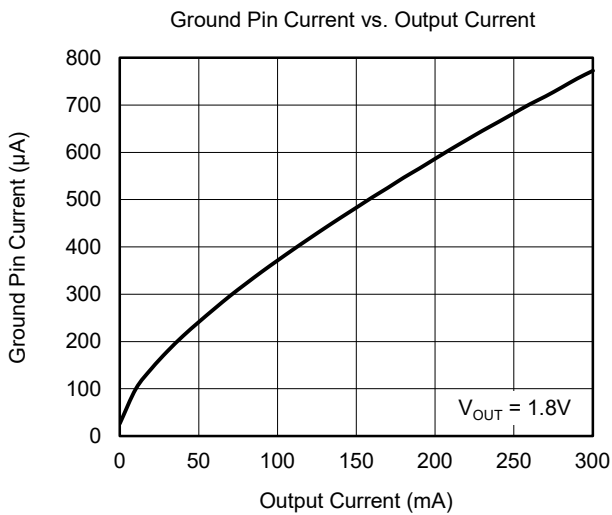
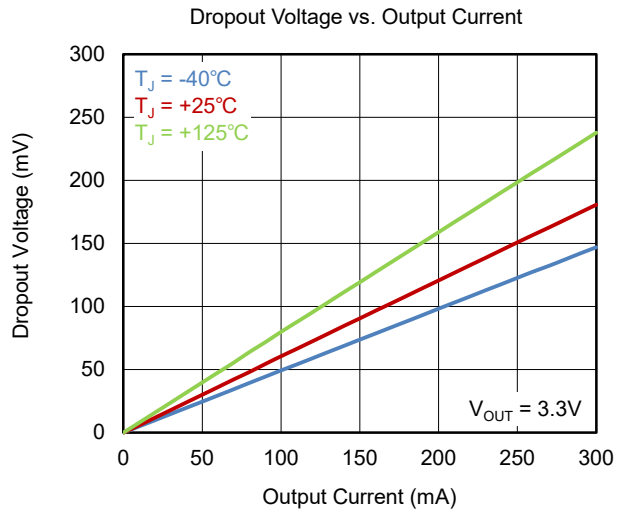
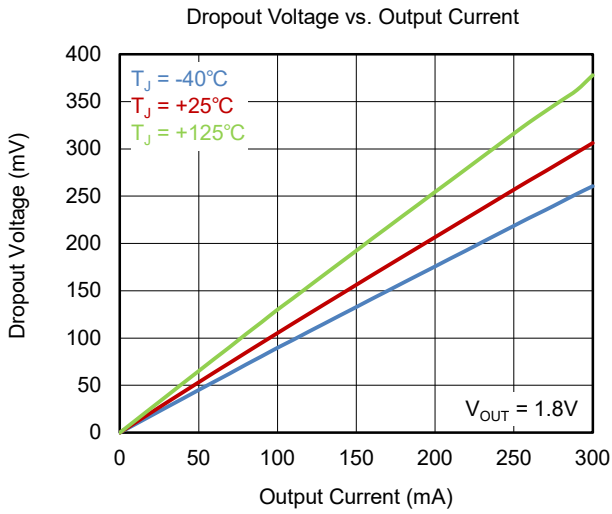

TYPICAL APPLICATION CIRCUITS

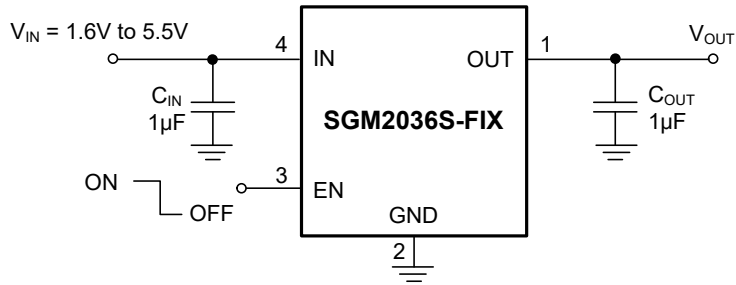

Figure 4. Fixed Output Version (XTDFN-1x1-4L)

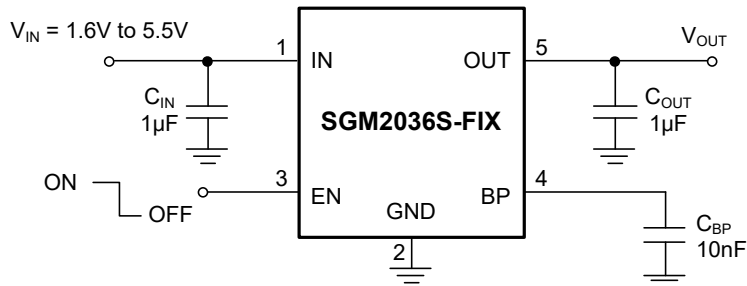
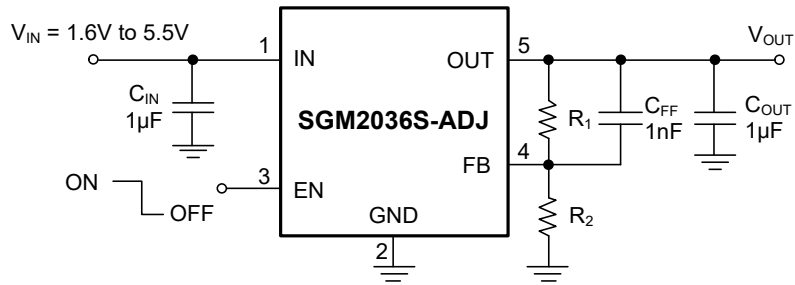

Figure 5. Fixed Output Version (SOT-23-5/SC70-5)



$$R_1 = R_2 \times \left( \frac{V_{OUT}}{0.8V} - 1 \right)$$

Figure 6. Adjustable Output Version (SOT-23-5/SC70-5)

## APPLICATION INFORMATION

The SGM2036S is a low input voltage, low noise and low dropout LDO and provides 300mA output current. These features make the device a reliable solution to solve many challenging problems in the generation of clean and accurate power supply. The high performance also makes the SGM2036S useful in a variety of applications. The SGM2036S provides the protection functions for output overload, output short-circuit condition and overheating.

The SGM2036S provides an EN pin as an external chip enable control to enable/disable the device. When the regulator is in shutdown state, the shutdown current consumes as low as 0.05 $\mu$ A (TYP).

### Input Capacitor Selection ( $C_{IN}$ )

The input decoupling capacitor should be placed as close as possible to the IN pin to ensure the device stability. 1 $\mu$ F or larger X7R or X5R ceramic capacitor is selected to get good dynamic performance.

When  $V_{IN}$  is required to provide large current instantaneously, a large effective input capacitor is required. Multiple input capacitors can limit the input tracking inductance. Adding more input capacitors is available to restrict the ringing and to keep it below the device absolute maximum ratings.

### Output Capacitor Selection ( $C_{OUT}$ )

The output capacitor should be placed as close as possible to the OUT pin. 1 $\mu$ F or larger X7R or X5R ceramic capacitor is selected to get good dynamic performance. The minimum effective capacitance of  $C_{OUT}$  that SGM2036S can remain stable is 0.5 $\mu$ F. For ceramic capacitor, temperature, DC bias and package size will change the effective capacitance, so enough margin of  $C_{OUT}$  must be considered in design. Additionally,  $C_{OUT}$  with larger capacitance and lower ESR will help increase the high frequency PSRR and improve the load transient response.

### Adjustable Regulator

The output voltage of the SGM2036S-ADJ can be adjusted from 0.8V to 5.0V. The FB pin will be connected to two external resistors as shown in Figure 7,

the output voltage is determined by the following equation:

$$V_{OUT} = V_{FB} \times \left( 1 + \frac{R_1}{R_2} \right) \quad (1)$$

where:

$V_{OUT}$  is output voltage and  $V_{FB}$  is the internal voltage reference,  $V_{FB} = 0.8V$ .

One parallel capacitor ( $C_{FF}$ ) with  $R_1$  can be used to improve the feedback loop stability and PSRR, increase the transient response and reduce the output noise. Use  $R_2 = 160k\Omega$  to maintain a 5 $\mu$ A minimum load.

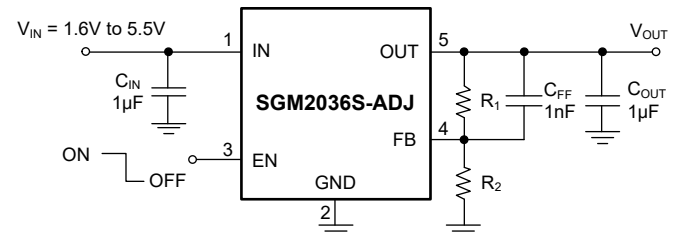

Figure 7. Adjustable Output Voltage Application

### Enable Operation

The EN pin of the SGM2036S is used to enable/disable its device and to deactivate/activate the output automatic discharge function.

When the EN pin voltage is lower than 0.4V, the device is in shutdown state. There is no current flowing from IN to OUT pins. In this state, the automatic discharge transistor is active to discharge the output voltage through a 75 $\Omega$  (TYP) resistor.

When the EN pin voltage is higher than 1.5V, the device is in active state. The output voltage is regulated to the expected value and the automatic discharge transistor is turned off.

The EN pin is pulled down by an internal pull-down resistor when the EN pin is floated. This current source will ensure the SGM2036S in shutdown state and reduce the power dissipation in system.

APPLICATION INFORMATION (continued)

Reverse Current Protection

The PMOS power transistor has an inherent body diode. This body diode will be forward biased when  $V_{OUT} > V_{IN}$ . When  $V_{OUT} > V_{IN}$ , the reverse current flowing from the OUT pin to the IN pin will damage the SGM2036S. If  $V_{OUT} > V_{IN}$  event would happen in system, one external diode will be added between OUT pin and IN pin in circuit design to protect the SGM2036S.

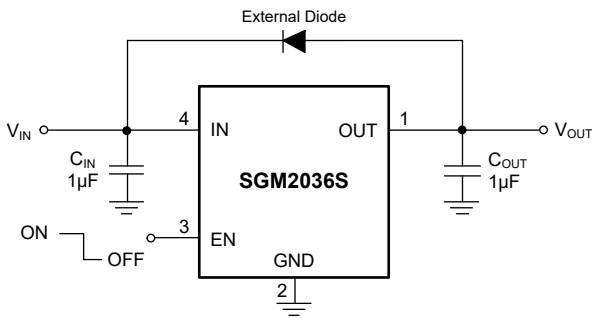

Figure 8. Reverse Protection Reference Design

Negatively Biased Output

When the output voltage is negative, the chip may not start up due to parasitic effects. Ensure that the output is greater than -0.3V under all conditions. If negatively biased output is excessive and expected in the application, a Schottky diode can be added between the OUT pin and GND pin.

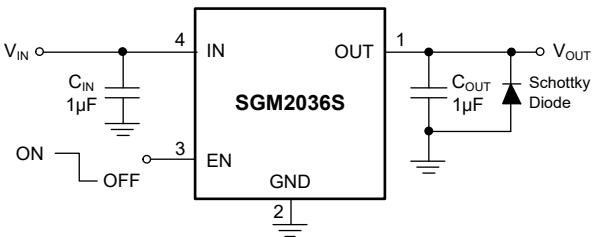

Figure 9. Negatively Biased Output Application

Output Current Limit and Short-Circuit Protection

When overload events happen, the output current is internally limited to 800mA (TYP). When the OUT pin is shorted to ground, the short-circuit protection will limit the output current to 380mA (TYP).

Thermal Shutdown

When the die temperature exceeds the threshold value of thermal shutdown, the SGM2036S will be in shutdown state and it will remain in this state until the die temperature decreases to +140°C.

Power Dissipation (PD)

Power dissipation ( $P_D$ ) of the SGM2036S can be calculated by the equation  $P_D = (V_{IN} - V_{OUT}) \times I_{OUT}$ . The maximum allowable power dissipation ( $P_{D(MAX)}$ ) of the SGM2036S is affected by many factors, including the difference between junction temperature and ambient temperature ( $T_{J(MAX)} - T_A$ ), package thermal resistance from the junction to the ambient environment ( $\theta_{JA}$ ), the rate of ambient airflow and PCB layout.  $P_{D(MAX)}$  can be approximated by the following equation:

$$P_{D(MAX)} = (T_{J(MAX)} - T_A) / \theta_{JA} \quad (2)$$

**REVISION HISTORY**

NOTE: Page numbers for previous revisions may differ from page numbers in the current version.

<b>NOVEMBER 2023 – REV.A.2 to REV.A.3</b>	<b>Page</b>
Updated Power Dissipation.....	5
Updated Package Thermal Resistance.....	5

<b>MAY 2023 – REV.A.1 to REV.A.2</b>	<b>Page</b>
Updated Pin Description.....	6

<b>APRIL 2023 – REV.A to REV.A.1</b>	<b>Page</b>
Added SGM2036S-3.6XN5G/TR to Package/Ordering Information section.....	2
Added SGM2036S-3.6XC5G/TR to Package/Ordering Information section.....	3
Added SGM2036S-3.6XXDH4G/TR to Package/Ordering Information section.....	4
Added SGM2036S-1.6XXDH4G/TR to Package/Ordering Information section.....	4

<b>Changes from Original (NOVEMBER 2022) to REV.A</b>	<b>Page</b>
Changed from product preview to production data.....	All



# PACKAGE INFORMATION

## PACKAGE OUTLINE DIMENSIONS

### XTDFN-1x1-4L

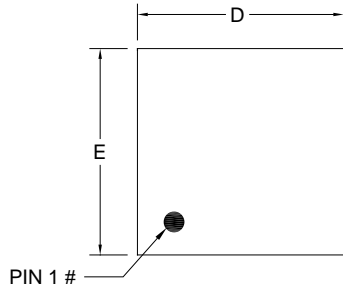

**TOP VIEW**

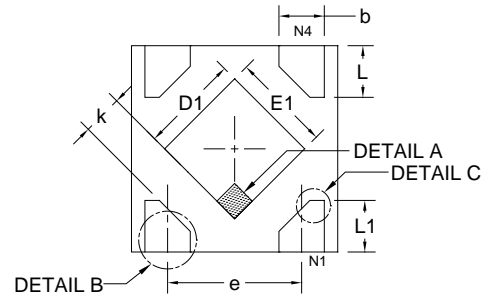

**BOTTOM VIEW**

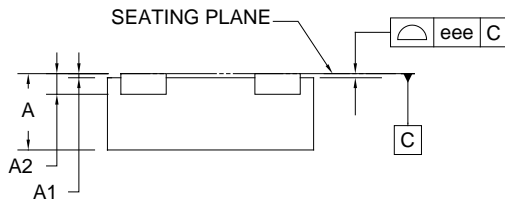

**SIDE VIEW**

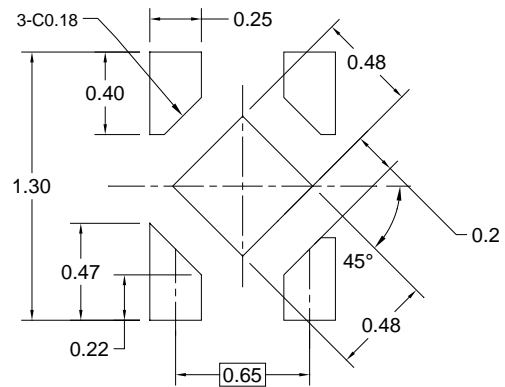

**RECOMMENDED LAND PATTERN (Unit: mm)**

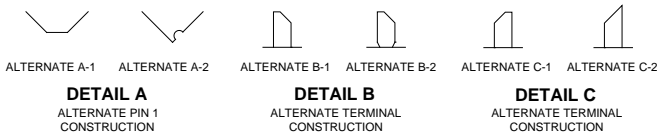

Symbol	Dimensions in Millimeters		
	MIN	MOD	MAX
A	0.340	0.370	0.400
A1	0.000	0.020	0.050
A2	0.100 REF		
b	0.170	-	0.300
D	0.950	1.000	1.050
E	0.950	1.000	1.050
D1	0.430	0.480	0.530
E1	0.430	0.480	0.530
L	0.200	0.250	0.300
L1	0.200	-	0.370
e	0.650 BSC		
k	0.150	-	-
eee	-	0.050	-

NOTE: This drawing is subject to change without notice.

# PACKAGE INFORMATION

## PACKAGE OUTLINE DIMENSIONS

### SOT-23-5

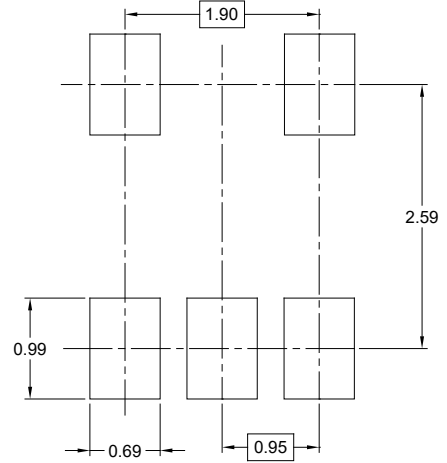
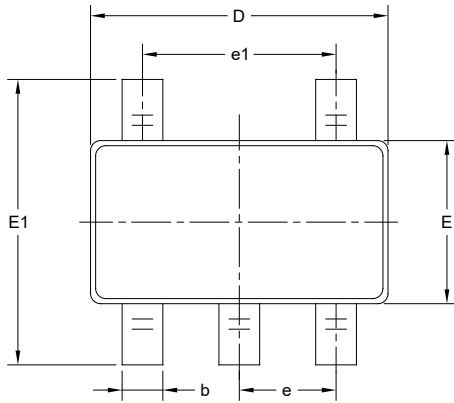

RECOMMENDED LAND PATTERN (Unit: mm)

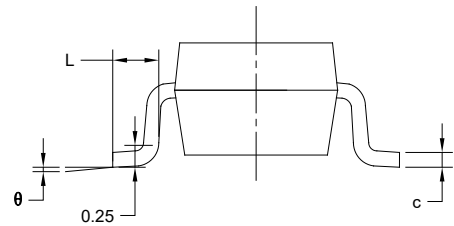
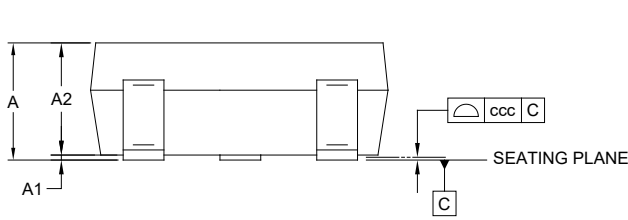

Symbol	Dimensions In Millimeters		
	MIN	MOD	MAX
A	-	-	1.450
A1	0.000	-	0.150
A2	0.900	-	1.300
b	0.300	-	0.500
c	0.080	-	0.220
D	2.750	-	3.050
E	1.450	-	1.750
E1	2.600	-	3.000
e	0.950 BSC		
e1	1.900 BSC		
L	0.300	-	0.600
$\theta$	0°	-	8°
ccc	0.100		

NOTES:

1. This drawing is subject to change without notice.
2. The dimensions do not include mold flashes, protrusions or gate burrs.
3. Reference JEDEC MO-178.

PACKAGE OUTLINE DIMENSIONS

SC70-5

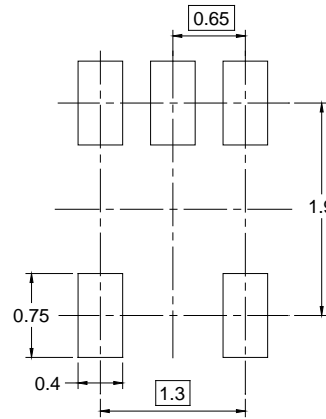
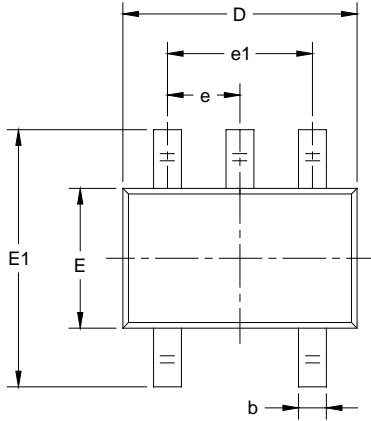

RECOMMENDED LAND PATTERN (Unit: mm)

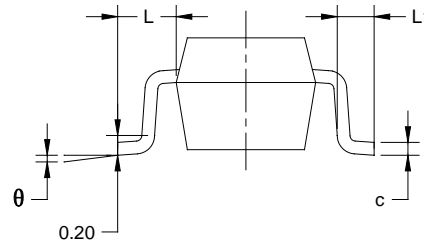
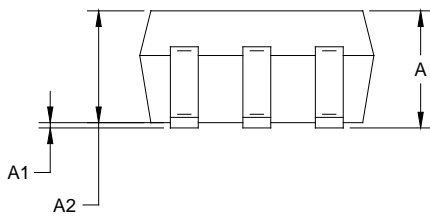

Symbol	Dimensions In Millimeters		Dimensions In Inches	
	MIN	MAX	MIN	MAX
A	0.800	1.100	0.031	0.043
A1	0.000	0.100	0.000	0.004
A2	0.800	1.000	0.031	0.039
b	0.150	0.350	0.006	0.014
c	0.080	0.220	0.003	0.009
D	2.000	2.200	0.079	0.087
E	1.150	1.350	0.045	0.053
E1	2.150	2.450	0.085	0.096
e	0.65 TYP		0.026 TYP	
e1	1.300 BSC		0.051 BSC	
L	0.525 REF		0.021 REF	
L1	0.260	0.460	0.010	0.018
$\theta$	0°	8°	0°	8°

NOTES:

1. Body dimensions do not include mode flash or protrusion.
2. This drawing is subject to change without notice.

# PACKAGE INFORMATION

## TAPE AND REEL INFORMATION

### REEL DIMENSIONS



### TAPE DIMENSIONS



NOTE: The picture is only for reference. Please make the object as the standard.

### KEY PARAMETER LIST OF TAPE AND REEL

Package Type	Reel Diameter	Reel Width W1 (mm)	A0 (mm)	B0 (mm)	K0 (mm)	P0 (mm)	P1 (mm)	P2 (mm)	W (mm)	Pin1 Quadrant
XTDFN-1×1-4L	7"	9.5	1.16	1.16	0.50	4.0	2.0	2.0	8.0	Q1
SOT-23-5	7"	9.5	3.20	3.20	1.40	4.0	4.0	2.0	8.0	Q3
SC70-5	7"	9.5	2.25	2.55	1.20	4.0	4.0	2.0	8.0	Q3

DD0001

# PACKAGE INFORMATION

## CARTON BOX DIMENSIONS



NOTE: The picture is only for reference. Please make the object as the standard.

## KEY PARAMETER LIST OF CARTON BOX

Reel Type	Length (mm)	Width (mm)	Height (mm)	Pizza/Carton
7" (Option)	368	227	224	8
7"	442	410	224	18

DD0002

单击下面可查看定价，库存，交付和生命周期等信息

[>>SGMICRO\(圣邦微电子\)](#)