

1 Product Description

The MT8632-3D is produced with CMOS technology. The Hall IC internally includes high sensitivity horizontal hall plates, sleep/awake logics for mode control, a low-power on-chip oscillator, low noise analog signal chain with dynamic offset cancellation, hysteresis comparators and an output driver.

The MT8632-3D integrated IMC into the IC, that makes MT8632-3D sensitive to the magnetic flux which from X & Y & Z axis.

The product responds to either North pole or South pole magnetic fields. The output will be turned on (Low) when the magnetic flux density (B) is larger than the operating point (BOP), and be turned off (High) when the magnetic flux density (B) is lower than the releasing point (BRP).

The MT8632-3D provides SOT-23-3L for surface mount. All packages are RoHS compliant.

2 Features

- CMOS Technology
- 3D Sensing (IMC Technology)
- Omni-polar Switch
- 2.0~5.5V Operating Vcc Range
- -40°C~125°C Operating Temperature
- Package Option:
SOT-23-3L
- Magnetic Sensitivity Option:
BOP=±16Gs, BRP=±9Gs
- Push Pull Output
- Nano Power Consumption:
Average Supply Current =600nA (Vcc=2.0V)
- RoHS Compliant: (EU)2015/863

3 Product Overview of MT8632-3D

Part No.	Description
MT8632AT-3D	SOT-23-3L, tape & reel (3000pcs/bag)

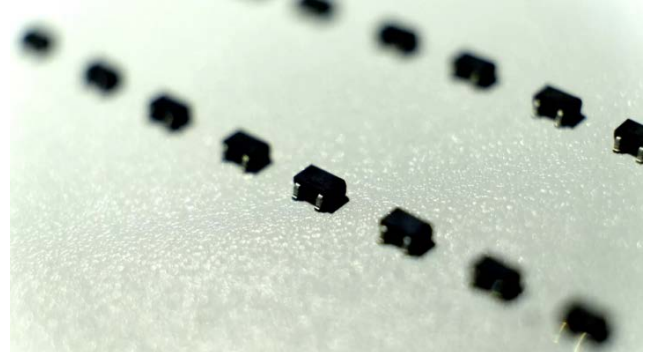

4 Applications

- Home appliances, Industrial
- Position Detection
- Solid-State Switch
- Proximity Switch
- Smart Meter
- Handheld Device
- Consumer Device

5. Pin Configuration and Functions

	Vcc	Out	GND
SOT-23-3L	1	2	3
Description	Power	Output Push Pull	Ground

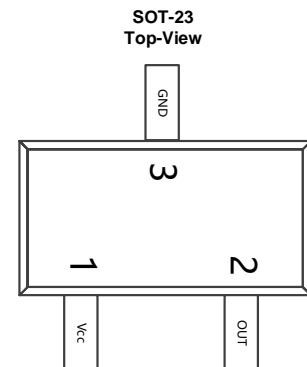

Figure.1 Pin Configuration & Functions

Table of Contents

1	Product Description.....	1
2	Features.....	1
3	Product Overview of MT8632-3D	1
4	Applications.....	1
5	Pin Configuration and Functions.....	1
6	Definition of Switching Function.....	3
7	Function Description.....	3
8	Feature Description.....	3
9	Functional Block Diagram.....	4
10	Electrical and Magnetic Characteristics.....	4
	10.1 Absolute Maximum Ratings.....	4
	10.2 Electrical Specifications.....	5
	10.3 Magnetic Characteristics.....	5
	10.4 ESD Ratings.....	5
	10.5 Characteristic Performance.....	6
	10.6 Typical Output Waveform.....	7
11	Typical Application Circuit.....	7
12	Package Material Information.....	8
	12.1 SOT-23-3L Package Information.....	8
13	Copy Rights and Disclaimer.....	9

Reversion History

1	Originally Version	
2	1.1 Version	Update Magnetic Characteristics

6 Definition of Switching Function

Figure.2 shows the device functionality and hysteresis

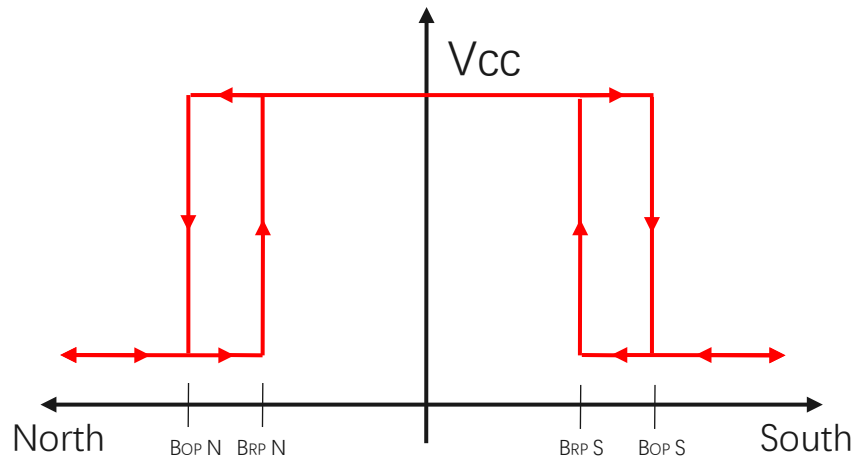

Figure.2 Omni-polar Switching Function

7 Function Description

B_{OP}: Operating Point, Magnetic flux density applied on the branded side of the package which turns the output driver ON ($V_{OUT}=Low$)

B_{RP}: Releasing Point, Magnetic flux density applied on the branded side of the package which turns the output driver OFF ($V_{OUT}=High$)

B_{HYST}: Hysteresis Window, $|B_{OP} - B_{RP}|$

Devices that have a lower magnetic threshold ($V_{OUT}=High$) detect magnets at a farther distance. Higher thresholds ($V_{OUT}=Low$) generally require a closer distance or larger magnet.

8 Feature Description

The MT8632-3D device is sensitive to the magnetic field from each axis of the chip



Figure.3 3D Sensing (South polar as example)

9 Functional Block Diagram

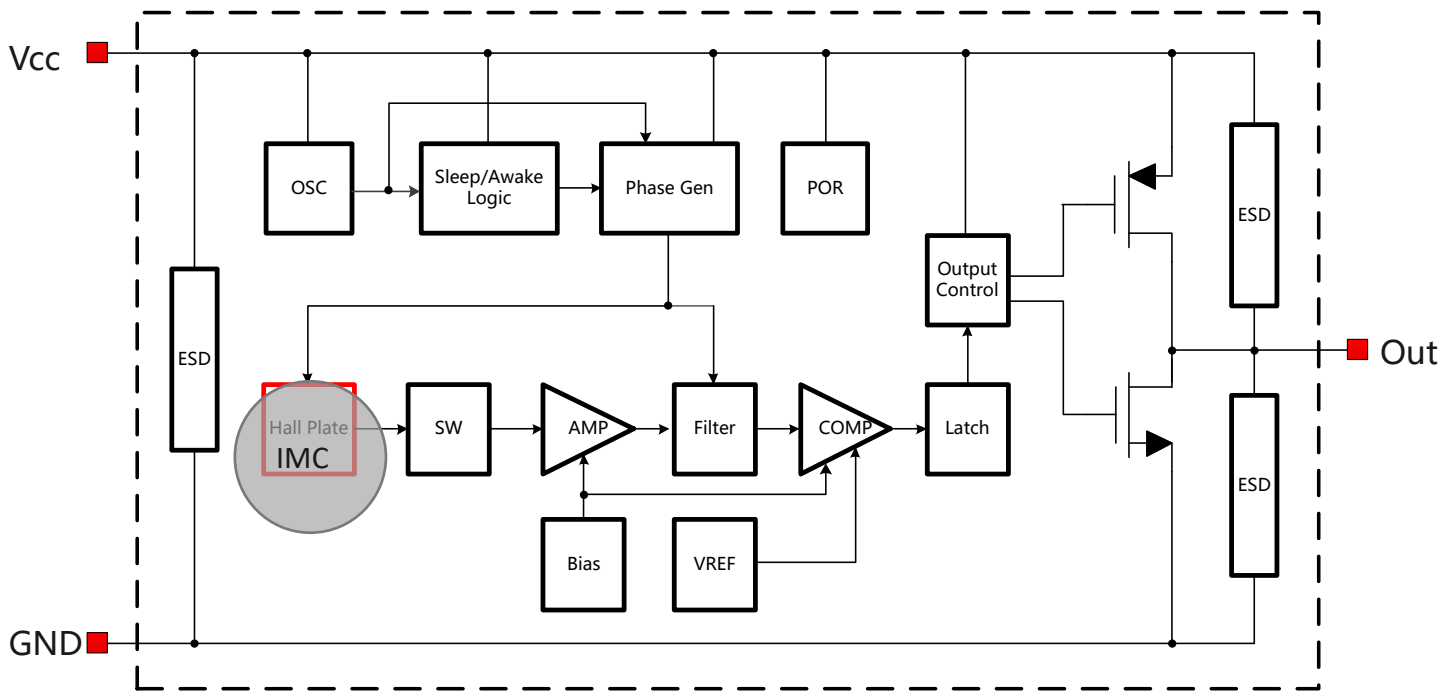

Figure.4 Functional Block Diagram

10 Electrical and Magnetic Characteristics

10.1 Absolute Maximum Ratings

Absolute maximum ratings are limited values to be applied individually, and beyond which the serviceability of the circuit may be impaired. Functional operability is not necessarily implied. Exposure to absolute maximum rating conditions for an extended period of time may affect device reliability.

Symbol	Parameters	Min	Max	Units
VCC	Supply Voltage	-	7	V
VRCC	Reverse Battery Voltage	-0.5	-	V
VOUT	Output Voltage	-	7	V
IOUT	Continuous Output Current	-	8	mA
TA	Operating Ambient Temperature	-40	125	°C
TS	Storage Temperature	-50	150	°C
TJ	Junction Temperature	-	165	°C
B	Magnetic Flux Density	No Limit		Gs

10.2 Electrical Specifications

At TA=-40~125°C, VCC=2.0V~5.5V (unless otherwise specified)

Symbol	Parameters	Test Condition	Min	Typ	Max	Unit
VCC	Supply Voltage	Operating	2.0	3.6	5.5	V
ICC	Supply Current	VCC=3.6V	-	1.2	2.0	uA
		VCC=2.0V	-	600	-	nA
I _{AW}	Awake Current	VCC=3.6V	-	3.0	5.0	mA
I _{SL}	Sleep Current	VCC=3.6V	-	0.6	1.4	uA
V _{OL}	Output Low Voltage	I _{OUT} =5mA, B > B _{OP}	-	-	0.4	V
V _{OH}	Output High Voltage	I _{OUT} =5mA, B < B _{RP}	VCC-0.4	-	-	V
F _{SW}	Switching Frequency	VCC=3.6V	10	20	40	Hz
T _{AW}	Awake Time	VCC=2.0V to 5.5V	4	10	16	us
T _{SL}	Sleep Time	VCC=2.0V to 5.5V	25	50	100	ms
D.C.	Duty Cycle	VCC=2.0V to 5.5V	-	0.02	-	%
T _{PO}	Power on Time	dVCC/dt>5V/us, B > B _{OP}	-	-	120	us
R _{TH}	Thermal Resistance of SOT-23-3L		-	301	-	°C/W

10.3 Magnetic Characteristics

At VCC=2.0V~5.5V (unless otherwise specified)

Part No.	Symbol	Min	Typ	Max	Unit
MT8632-3D Series	BOP, TA =25°C, Z axis	±8	±16	±24	Gs
	BRP, TA =25°C, Z axis	±2	±9	±16	Gs
	BHYST, TA =25°C, Z axis	-	7	-	Gs
	BOP, TA =25°C, X & Y axis	-	±16	-	Gs
	BRP, TA =25°C, X & Y axis	-	±9	-	Gs
	BHYST, TA =25°C, X & Y axis	-	7	-	Gs

10.4 ESD Ratings

Symbol		Reference	Values	Unit
V _{ESD}	Human-body model (HBM)	AEC-Q100-002	±5000	V
	Charged-device model (CDM)	AEC-Q100-011	±1000	V

10.5 Characteristic Performance

At $V_{CC}=3.6V$

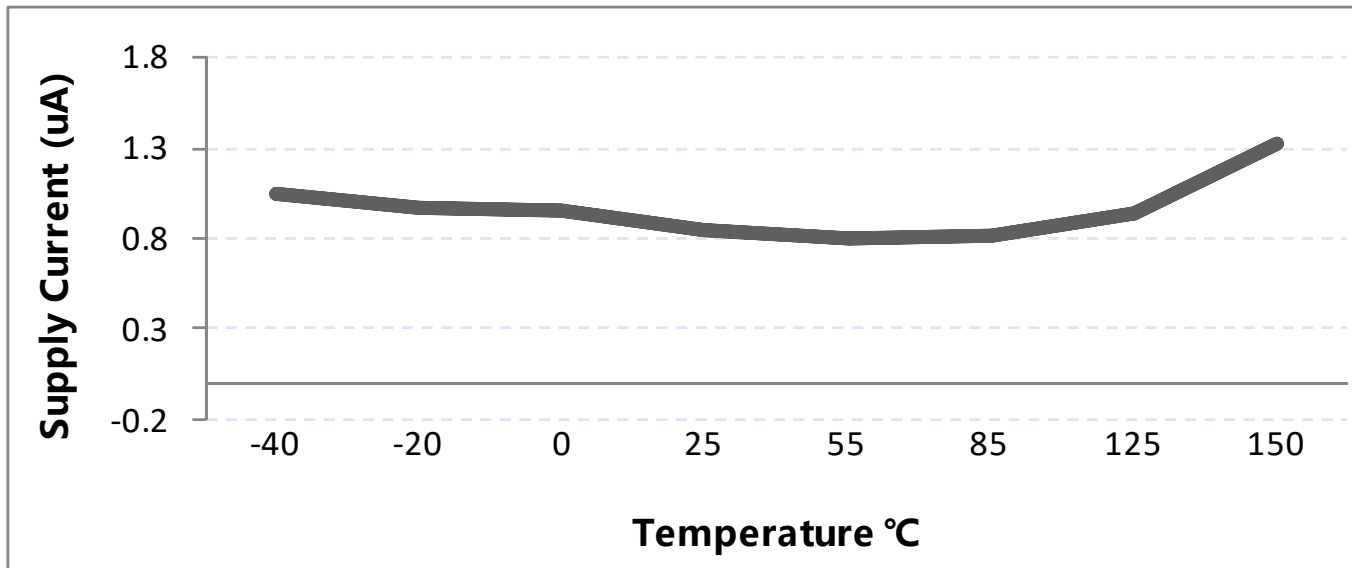

Figure.5 Supply Current vs. Temperature

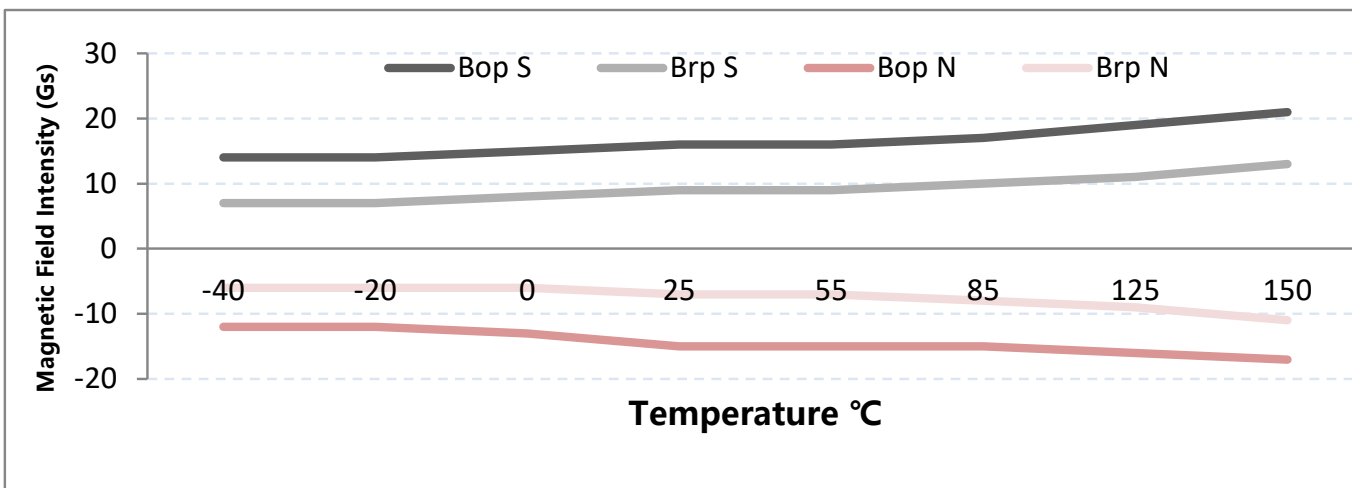

Figure.6 Magnetic Characteristics vs. Temperature (BOP & BRP) , Z axis as example

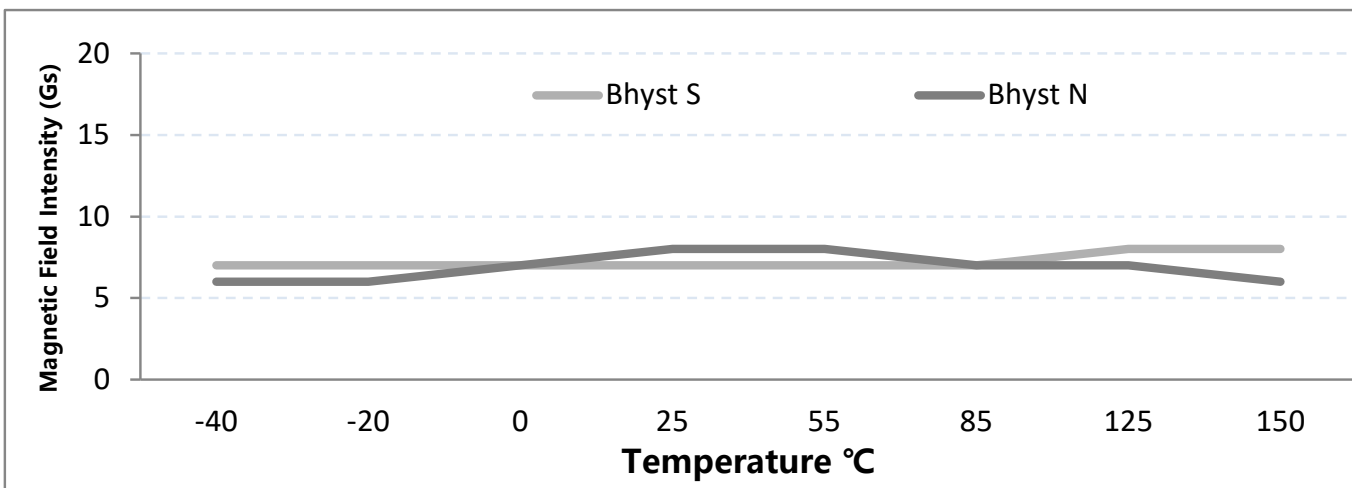

Figure.7 Magnetic Characteristics vs. Temperature (BHYST) , Z axis as example

10.6 Typical Output Waveform

MT8632AT-3D as example

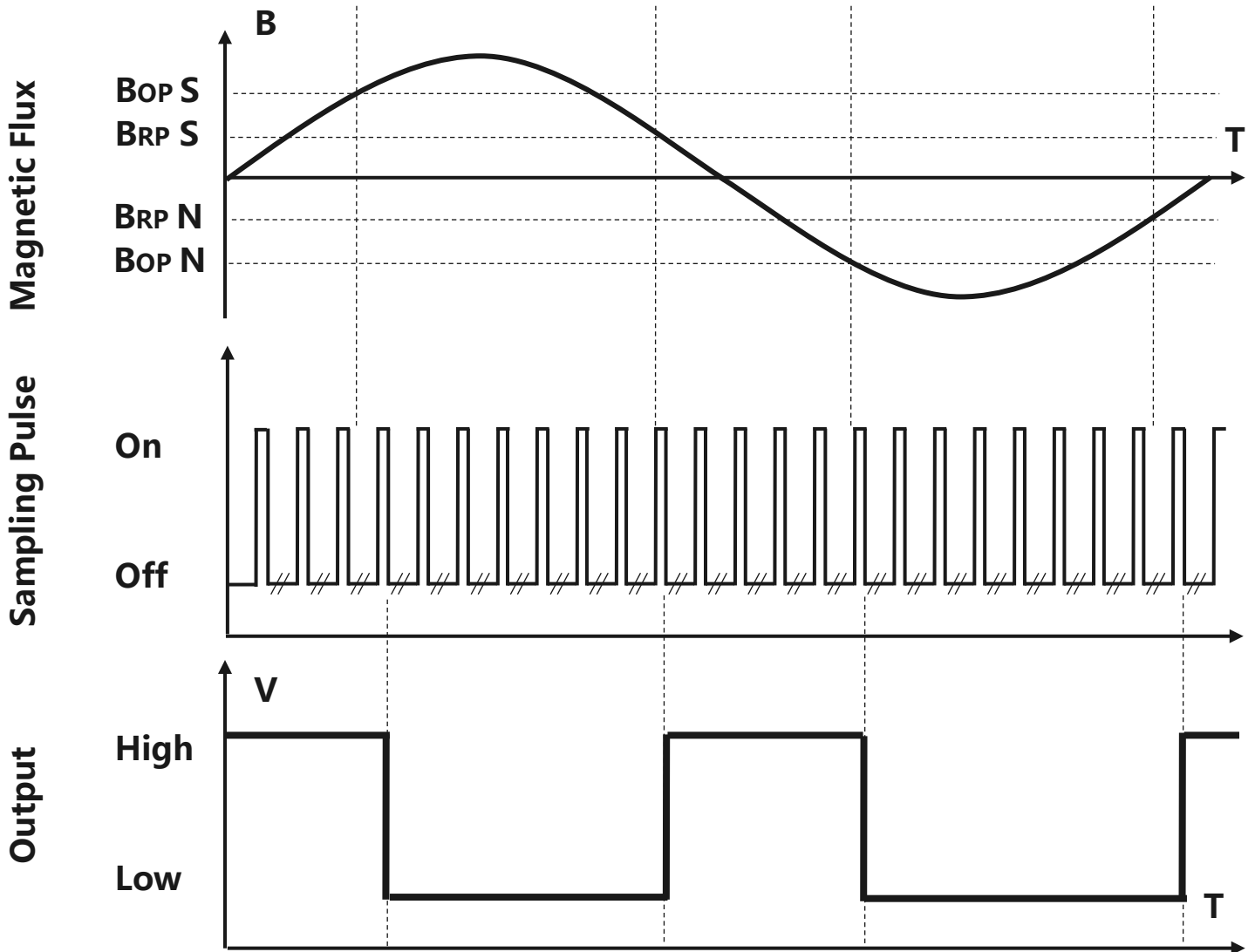

Figure.8 Digital Output vs. Magnetic Flux Density

11 Typical Application Circuit

MT8632AT-3D as example

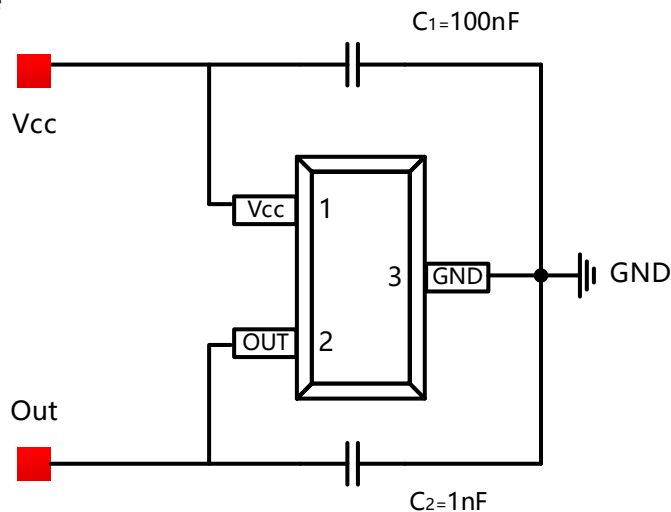

Figure.9 Typical Application Circuit

12 Package Material Information (For Reference Only – Not for Tooling Use)

12.1 SOT-23-3L Package Information

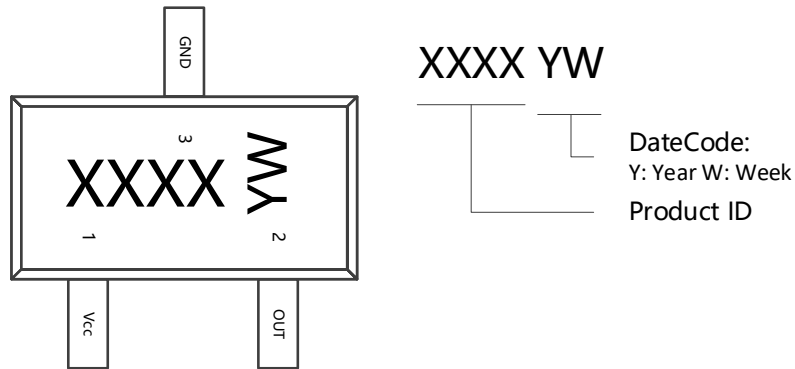

Figure.10 SOT-23-3L Chip Marking Spec

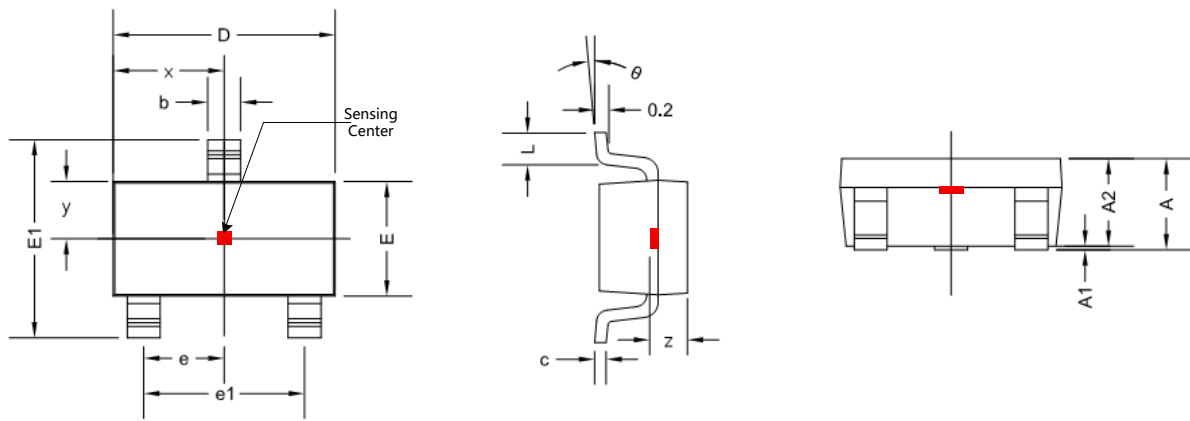

Figure.11 SOT-23-3L Package Drawing

Symbol	Dimensions in Millimeters		Dimensions in Inches	
	Min	Max	Min	Max
A	1.050	1.300	0.041	0.051
A1	0.000	0.150	0.000	0.006
A2	1.000	1.200	0.039	0.047
b	0.300	0.500	0.012	0.020
c	0.080	0.220	0.003	0.009
D	2.800	3.020	0.110	0.119
E	1.500	1.700	0.059	0.067
E1	2.600	3.000	0.102	0.118
e	0.950 TYP		0.037 TYP	
e1	1.800	2.000	0.071	0.079
L	0.300	0.600	0.012	0.024
θ	0 °	8 °	0 °	8 °
x	1.460 TYP		0.057 TYP	
y	0.800 TYP		0.032 TYP	
z	0.600 TYP		0.024 TYP	

13 Copy Rights and Disclaimer

1. This document may not be reproduced or duplicated, in any form, in whole or in part without prior written consent of MagnTek . Copyrights © 2019, MagnTek Incorporated.
2. MagnTek reserves the right to make changes to the information published in this document at anytime without notice.
3. MagnTek' s products are limited for use in normal commercial applications. MagnTek' s products are not to be used in any device or system, including but not limited to medical life support equipment and system.

For the latest version of this document, please visit our website: www.magntek.com.cn

单击下面可查看定价，库存，交付和生命周期等信息

[>>Magntek\(麦歌恩\)](#)