

# 2.75V-42V, Low I<sub>Q</sub>, LDO Linear Regulator

## 1 FEATURES

- Automotive AEC-Q100 Grade 1 Compliance
- Ultra-Low I<sub>Q</sub> < 5.5μA
- Wide Input Voltage Range: 2.75V to 42V
- ±2%, 3.3V, 5V and 15V Fixed Outputs and 0.6V to 24V Adjustable Output
- Up to 200mA/100mA Output Current
- Shutdown Current < 1μA
- PG Indicator with Adjustable Delay for MCU Applications
- High PSRR 70dB @ 100Hz
- Stable Close-Loop Operation with only 1μF Low-ESR Ceramic Output Capacitor
- Low Dropout: 130mV @ 100mA
- Up to 42V High Voltage EN Pin with Logic Threshold
- Over-Current Protection
- Over Temperature Shutdown and Auto Restart
- Internal Soft Start
- -40°C to 150 °C Junction Temperature
- Thermally Enhanced MSOP-EP8 Package

## 2 APPLICATIONS

- Automotive Power Supplies
- Industrial Power Supplies
- Battery Powered Systems

## 3 DESCRIPTION

LN20X42/1Q1 are ultra-low quiescent current, low dropout linear regulators (LDOs) with a wide input voltage range of 2.75V to 42V. The series provides 3.3V, 5V and 15V fixed outputs or 0.6V to 24V adjustable output, and delivers up to 100mA or 200mA output current. The shutdown current of LN20X42/1Q1 is less than 1μA, while the quiescent current under no-load condition is less than 5.5μA.

LN20X42/1Q1 provides a power good indicator with programmable delay to directly drive the reset pin of a microprocessor (MCU), moreover, there are options of highly accurate fixed output of 5V or 3.3V.

LN20X42/1Q1 features over-current protection and over-temperature shutdown with auto restart. The product family is available in thermally enhanced MSOP-EP8 package.

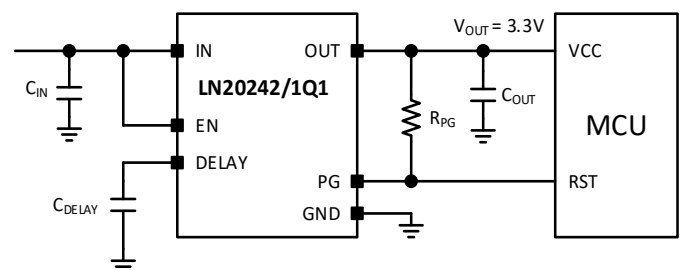

Typical MCU Application Diagram

**CONTENT**

1 FEATURES ..... 1

2 APPLICATIONS ..... 1

3 DESCRIPTION ..... 1

4 VERSION HISTORY ..... 3

5 PRODUCT AND ORDER INFORMATION ..... 4

    5.1 Product Infomation ..... 4

    5.2 Ordering Information ..... 5

6 PIN CONFIGURATION AND FUNCTION ..... 6

    6.1 With PG and DELAY Pins ..... 6

    6.2 Low I<sub>Q</sub> (Without PG and DELAY Pins) ..... 7

    6.3 Package Thermal Parameters ..... 7

7 SPECIFICATIONS ..... 8

    7.1 Absolute Maximum Ratings ..... 8

    7.2 ESD Ratings ..... 8

    7.3 Recommended Operating Condition ..... 8

    7.4 Electrical Characteristics ..... 9

    7.5 Typical Characteristics ..... 11

8 FUNCTIONAL DESCRIPTION ..... 15

    8.1 Overview ..... 15

    8.2 Funtional Diagram ..... 15

9 APPLICATIONS ..... 16

    9.1 Applicaiton Diagram with Full Features ..... 16

    9.2 Minimum Application Diagram ..... 16

    9.3 Application Considerations ..... 16

10 PACKAGE INFORMATION ..... 18

    10.1 Package Outline ..... 18

    10.2 Footprint Example ..... 19

**IMPORTANT NOTICE AND DISCLAIMERS ..... 20**

**ENVIRONMENTAL DECLARATION ..... 20**

4 VERSION HISTORY

Version	Change Record	Time
1.0	Initial release	2021/10/12

**5 PRODUCT AND ORDER INFORMATION**

**5.1 Product Information**

Part Number	X	Y	DFR
LN20X4YQ1-DFR	0: Adjustable $V_{OUT}$ , with PG and PG delay 1: Adjustable $V_{OUT}$ , low $I_Q$ 2: fixed 3.3V $V_{OUT}$ , with PG and PG delay 3: fixed 3.3V $V_{OUT}$ , low $I_Q$ 4: fixed 5V $V_{OUT}$ , with PG and PG delay 5: fixed 5V $V_{OUT}$ , low $I_Q$ 6: fixed 15V $V_{OUT}$ , with PG and PG delay 7: fixed 15V $V_{OUT}$ , low $I_Q$	1: 100mA 2: 200mA	IC Package: MSOP-EP8 MSL: Level-2-260C Material: RoHS Package: T@R Quantity: 3000 Top Marking: as follows

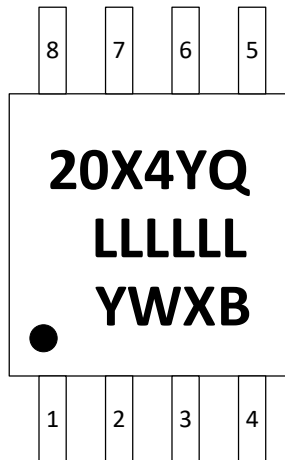

20X4YQ: Part Number

LLLLLL: Lot ID

YWXB: Date Code

## 5.2 Ordering Information

Part Number	V <sub>OUT</sub>	Max Load	PG	I <sub>Q</sub>	Package	Package Qty
LN20041Q1-DFR	Adjustable	100mA	Yes	7.5uA	Tape & Reel	3000
LN20141Q1-DFR	Adjustable	100mA	No	5.5uA	Tape & Reel	3000
LN20241Q1-DFR	Fixed 3.3V	100mA	Yes	7.5uA	Tape & Reel	3000
LN20341Q1-DFR	Fixed 3.3V	100mA	No	5.5uA	Tape & Reel	3000
LN20441Q1-DFR	Fixed 5V	100mA	Yes	7.5uA	Tape & Reel	3000
LN20541Q1-DFR	Fixed 5V	100mA	No	5.5uA	Tape & Reel	3000
LN20641Q1-DFR	Fixed 15V	100mA	Yes	7.5uA	Tape & Reel	3000
LN20741Q1-DFR	Fixed 15V	100mA	No	5.5uA	Tape & Reel	3000
LN20042Q1-DFR	Adjustable	200mA	Yes	7.5uA	Tape & Reel	3000
LN20142Q1-DFR	Adjustable	200mA	No	5.5uA	Tape & Reel	3000
LN20242Q1-DFR	Fixed 3.3V	200mA	Yes	7.5uA	Tape & Reel	3000
LN20342Q1-DFR	Fixed 3.3V	200mA	No	5.5uA	Tape & Reel	3000
LN20442Q1-DFR	Fixed 5V	200mA	Yes	7.5uA	Tape & Reel	3000
LN20542Q1-DFR	Fixed 5V	200mA	No	5.5uA	Tape & Reel	3000
LN20642Q1-DFR	Fixed 15V	200mA	Yes	7.5uA	Tape & Reel	3000
LN20742Q1-DFR	Fixed 15V	200mA	No	5.5uA	Tape & Reel	3000

## 6 PIN CONFIGURATION AND FUNCTION

### 6.1 With PG and DELAY Pins

#### 6.1.1 Pin Configuration

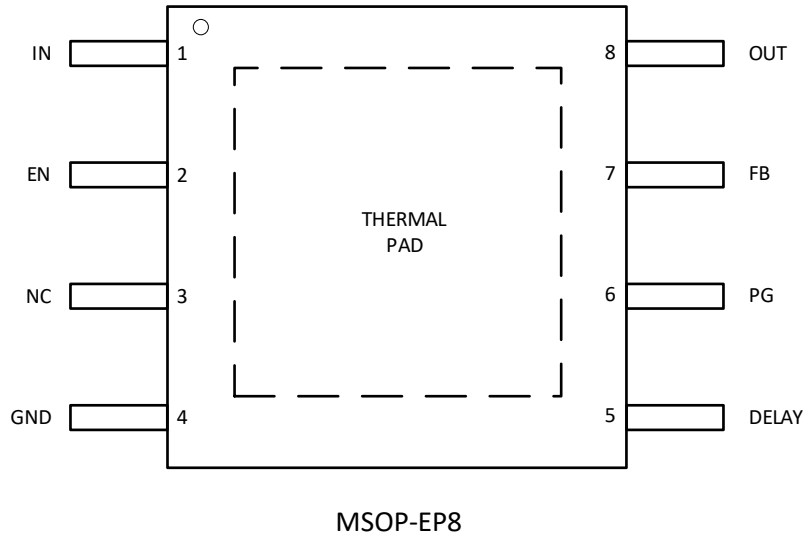

#### 6.1.2 Pin Function

Name	Number	Description
<b>IN</b>	1	Input pin, place a ceramic capacitor of at least 1 $\mu$ F between IN and GND.
<b>EN</b>	2	Enable pin, connect to a logic control signal or to IN directly.
<b>NC</b>	3	Connect to GND.
<b>GND</b>	4	Connect to GND.
<b>DELAY</b>	5	Power good delay pin, place a ceramic capacitor between DELAY and GND.
<b>PG</b>	6	Power good pin, open drain, connect a pull-up resistor between PG and an external supply or to OUT pin, if not used, keep floating.
<b>FB</b>	7	Feedback pin, connect to the center leg of the voltage divider between OUT and GND. This pin has no internal connection for fixed output versions
<b>OUT</b>	8	Output pin, place a ceramic capacitor of at 1 $\mu$ F between OUT and GND.

## 6.2 Low I<sub>Q</sub> (Without PG and DELAY Pins)

### 6.2.1 Pin Configuration

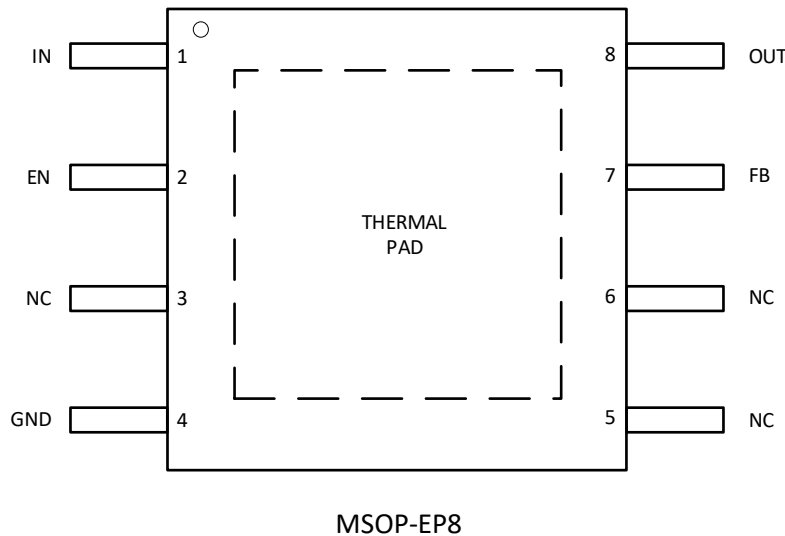

### 6.2.2 Pin Function

Name	Number	Description
IN	1	Input pin, place a ceramic capacitor of at least 1 $\mu$ F between IN and GND.
EN	2	Enable pin, connect to a logic control signal or to IN directly.
NC	3	Connect to GND.
GND	4	Connect to GND.
NC	5	Connect to GND.
NC	6	Connect to GND.
FB	7	Feedback pin, connect to the center leg of the voltage divider between OUT and GND. This pin has no internal connection for fixed output versions.
OUT	8	Output pin, place a ceramic capacitor of at 1 $\mu$ F between OUT and GND.

## 6.3 Package Thermal Parameters

Parameter <sup>(1)</sup>		MSOP-EP8	Units
R <sub>θJA</sub>	Junction-to-Ambient Thermal Resistance	58	°C/W
ψ <sub>JT</sub>	Junction-to-Top Characterization Parameter	3	°C/W

(1) Measurements are based on standard 2s2p PCB defined in JESD 51-7 2s2p, under no wind, 2W loss, and 25 °C ambient temperature.

## 7 SPECIFICATIONS

### 7.1 Absolute Maximum Ratings

Parameters	Min	Max	Unit
$V_{IN}$	-0.3	45	V
$V_{EN}$	-0.3	$V_{IN}$	
$V_{FB}$	-0.3	5.5	
$V_{PG}$	-0.3	5.5	
$V_{OUT}$	-0.3	$V_{IN}$	
$V_{DELAY}$	-0.3	2	
Junction Temperature	-40	150	°C
Storage Temperature	-55	150	

### 7.2 ESD Ratings

Parameters	Min	Max	Unit
HBM Human Body Model		±3000	V
CDM Charge Device Model		±750	

### 7.3 Recommended Operating Condition

Parameters	Min	Max	Unit
$V_{IN}$	-0.3	42	V
$V_{EN}$	-0.3	$V_{IN}$	
$V_{FB}$	-0.3	0.7	
$V_{PG}$	-0.3	5.5	
$V_{OUT}$	-0.3	24	
$V_{DELAY}$	-0.3	2	
Junction Temperature	-40	150	°C



## 7.4 Electrical Characteristics

Unless otherwise stated, the minimum and maximum limits apply over the recommended operating junction temperature range of -40°C to 150°C. Typical values are measured at 25°C and represent the most likely norm. The default conditions apply:  $V_{IN} = 13.5V$ .

Symbol	PARAMETER	CONDITIONS	MIN	TYP	MAX	UNITS
<b>VIN, VOUT (IN, OUT, GND PINS)</b>						
$V_{IN}$	Operating Input Voltage Range		2.75		42	V
$V_{OUT}$	Operating Output Voltage Range for Adjustable Output		0.6		24	V
$I_{Q-SH}$	Input Shutdown Current	$V_{EN} = 0V, V_{IN} = 13.5V$		0.8	3	$\mu A$
$I_{Q-NL}$	Input Quiescent Current	$V_{EN} = 5V, V_{IN} = 13.5V, I_{OUT} = 0A$		5.5	15	$\mu A$
$I_{Q-NL}$	Input Quiescent Current with PG Function	$V_{EN} = 5V, V_{IN} = 13.5V, I_{OUT} = 0A$		7.5	17	$\mu A$
<b>REGULATION, (OUT, FB PINS)</b>						
$V_{FB}$	Regulated Feedback Voltage	$V_{FB} = V_{OUT}, 28V > V_{IN} > 4.3V, I_{OUTMAX} > I_{OUT} > 1mA$	0.588	0.6	0.612	V
		$V_{FB} = V_{OUT}, 42V > V_{IN} > 28V, 75% * I_{OUTMAX} > I_{OUT} > 1mA$				
$I_{FB}$	Feedback Input Leakage Current	$V_{FB} = 0.6V$	-0.1	0	0.1	$\mu A$
$V_{OUT\%}$	Regulated Output Voltage Error for Fixed $V_{OUT}$ Parts	$28V > V_{IN} > V_{OUT} + 1V, I_{OUTMAX} > I_{OUT} > 1mA$	-2		2	%
		$42V > V_{IN} > 28V, 75% * I_{OUTMAX} > I_{OUT} > 1mA$				
	Line Regulation	$42V > V_{IN} > V_{OUT} + 1V, 75% * I_{OUTMAX} > I_{OUT} > 1mA$		$\pm 0.1$		%
	Load Regulation	$42V > V_{IN} > V_{OUT} + 1V, 75% * I_{OUTMAX} > I_{OUT} > 1mA$		$\pm 0.5$		%
<b>DROP OUT</b>						
$V_{DO-100mA}$	Drop Out Voltage	$I_{OUT} = 100mA, V_{IN} = 0.9 * V_{OUT}, V_{OUT} \geq 5V$		130		mV
$V_{DO-200mA}$	Drop Out Voltage	$I_{OUT} = 200mA, V_{IN} = 0.9 * V_{OUT}, V_{OUT} \geq 5V$		260		mV
$V_{DO-100mA-3.3V}$	Drop Out Voltage	$I_{OUT} = 100mA, V_{IN} = 0.9 * V_{OUT}, V_{OUT} = 3.3V$		200		mV
$V_{DO-200mA-3.3V}$	Drop Out Voltage	$I_{OUT} = 200mA, V_{IN} = 0.9 * V_{OUT}, V_{OUT} = 3.3V$		400		mV

**Electrical Characteristics (Continued)**

Unless otherwise stated, the minimum and maximum limits apply over the recommended operating junction temperature range of -40°C to 150°C. Typical values are measured at 25°C and represent the most likely norm. The default conditions apply:  $V_{IN} = 13.5V$ .

<b>OVER CURRENT PROTECTION</b>						
$I_{LIMIT-100mA}$	Current Limit Threshold	$V_{OUT} = 90\% * V_{OUT-NOM},$ $V_{IN} = 13.5V$	100	180	250	mA
$I_{LIMIT-200mA}$	Current Limit Threshold	$V_{OUT} = 90\% * V_{OUT-NOM},$ $V_{IN} = 13.5V$	200	280	500	mA
<b>POWER SUPPLY REJECTION RATIO (PSRR)</b>						
$G_{PSRR-100Hz}$	PSRR@100Hz	$I_{OUT} = 50mA, V_{OUT} = 5V$ or 3.3V	70 <sup>(1)</sup>			dB
<b>ENABLE (EN PIN)</b>						
$V_{EN}$	EN Pin Voltage Range		-0.3	$V_{IN}$		V
$V_{EN-H}$	EN Enable Threshold Voltage		2			V
$V_{EN-L}$	EN Disable Threshold Voltage		0.4			V
$I_{EN-H}$	EN Leakage Current	$V_{EN} = 5V$	0.5	2	$\mu A$	
<b>THERMAL SHUTDOWN</b>						
	Thermal Shutdown Threshold		151	170 <sup>(1)</sup>		°C
	Thermal Shutdown Recovery Hysteresis		13 <sup>(1)</sup>			°C
<b>POWER GOOD (PG, DELAY PINS)</b>						
$V_{PG-RISE}$	Power Good Rising Threshold	$V_{FB}$ Ramping Up	87	92.5	98	%
$V_{PG-FALL}$	Power Good Falling Threshold	$V_{FB}$ Ramping Down	83.5	88	92.5	%
$R_{PG-DN}$	Power Good Internal Pull-Down Resistor	$V_{PG} = 1V$	280			$\Omega$
$I_{D-CHARGE}$	Delay Capacitor Charge Current	$V_D = 1V$	2.35			$\mu A$
$I_{D-DISCHARGE}$	Delay Capacitor Discharge Current	$V_D = 1V$	18			mA
$V_{D-RISE}$	Delay Rising Threshold		0.80			V
$V_{D-FALL}$	Delay Falling Threshold		0.70			V

(1) Not subject to production test, specified by bench characterization.

## 7.5 Typical Characteristics

### 7.5.1 Characteristics Over Temperature

Unless otherwise stated, the test conditions are the same as Chapter 7.4.  $T_J = -40^{\circ}\text{C}$  to  $150^{\circ}\text{C}$ .

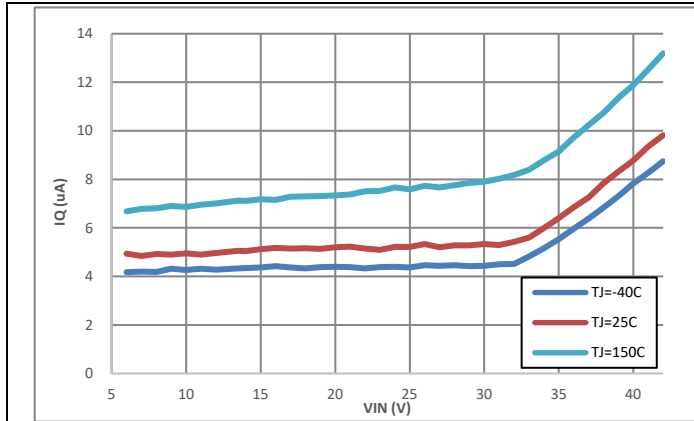

LN20542Q1, Fixed  $V_{OUT} = 5\text{V}$ , No load

Figure 1.  $I_Q$

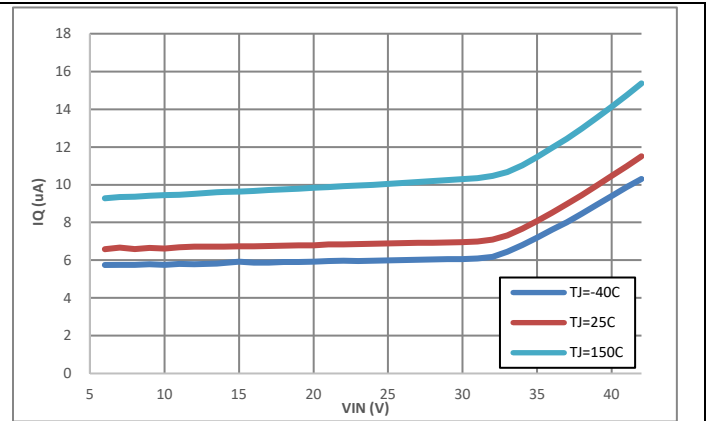

LN20442Q1, Fixed  $V_{OUT} = 5\text{V}$ , With PG, No load

Figure 2.  $I_Q$  WithPG Function

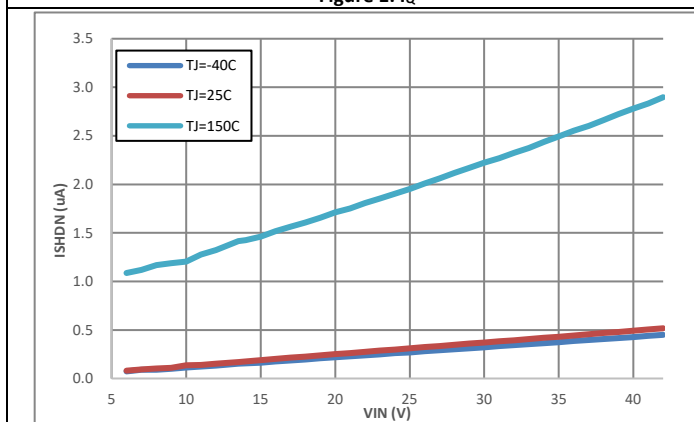

LN20442Q1, Fixed  $V_{OUT} = 5\text{V}$ , No load

Figure 3.  $I_{SHDN}$

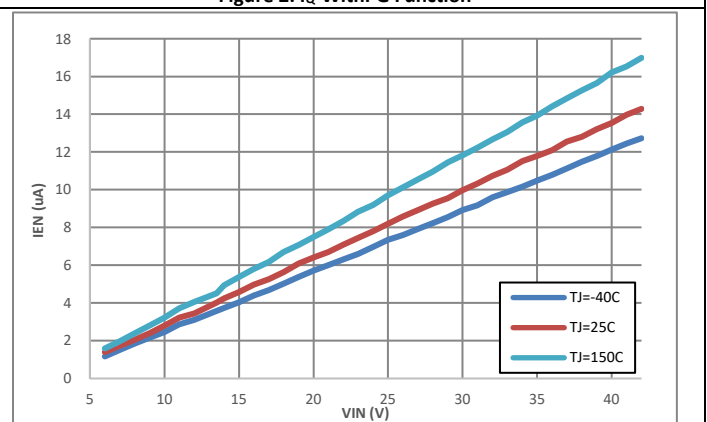

LN20442Q1, Fixed  $V_{OUT} = 5\text{V}$ , No load

Figure 4.  $I_{EN}$

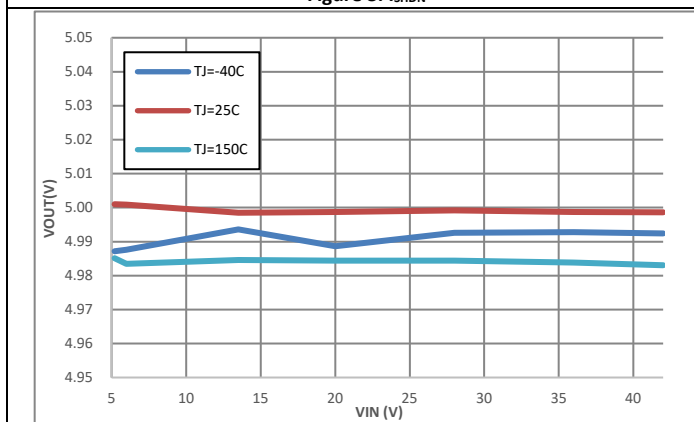

LN20042Q1, Adjustable  $V_{OUT} = 5\text{V}$ ,  $I_{OUT} = 1\text{mA}$

Figure 5. Line Regulation

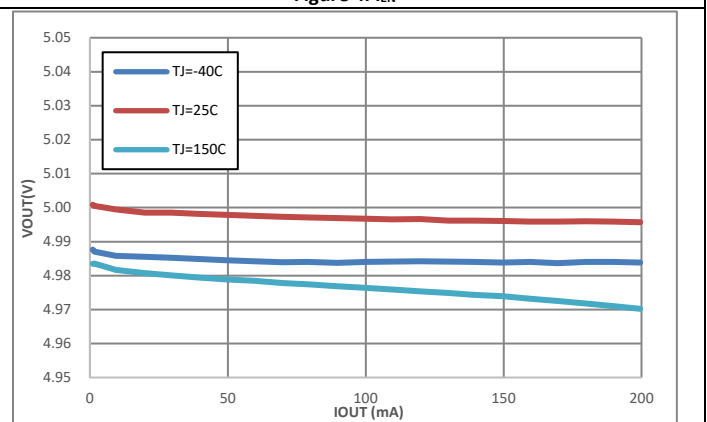

LN20042Q1, Adjustable  $V_{OUT} = 5\text{V}$ ,  $V_{IN} = 13.5\text{V}$

Figure 6. Load Regulation

Characteristics Over Temperature (Continued)

Unless otherwise stated, the test conditions are the same as Chapter 7.4.  $T_j = -40^{\circ}\text{C}$  to  $150^{\circ}\text{C}$ .

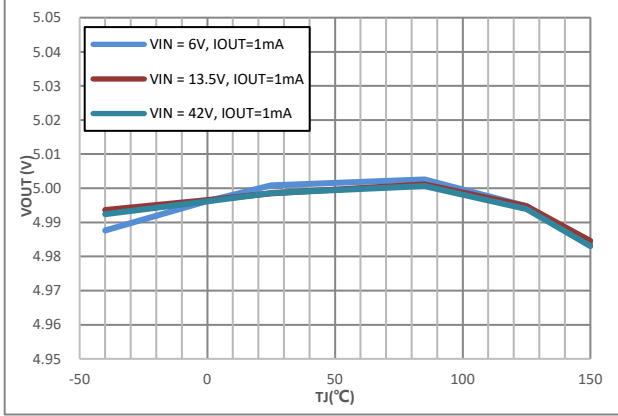

LN20042Q1, Adjustable  $V_{OUT} = 5\text{V}$ ,  $I_{OUT} = 1\text{mA}$   
Figure 7.  $V_{OUT}$  vs. Temperature

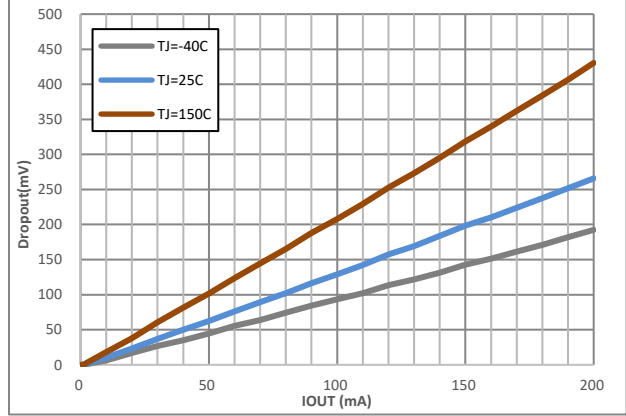

LN20042Q1, Adjustable  $V_{OUT} = 5\text{V}$   
Figure 8. Dropout

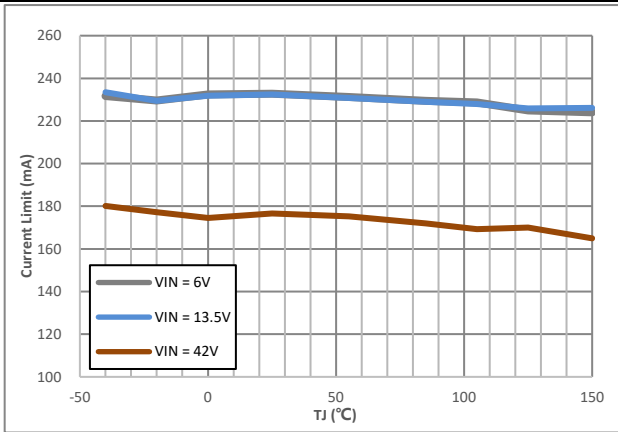

LN20041Q1, Adjustable  $V_{OUT} = 5\text{V}$ , Measured at  $V_{OUT}$  short  
Figure 9. 100mA Current Limit vs. Temperature

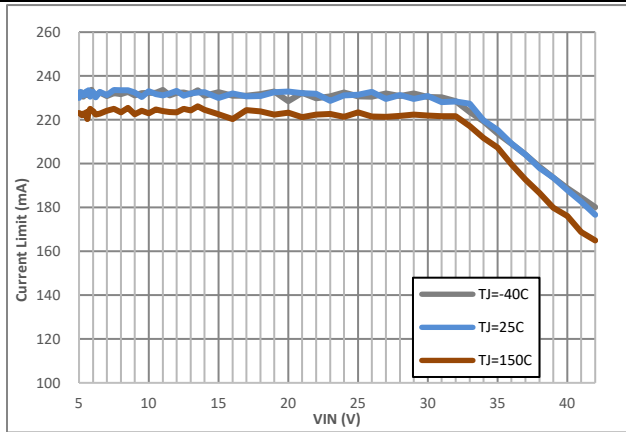

LN20041Q1, Adjustable  $V_{OUT} = 5\text{V}$ , Measured at  $V_{OUT}$  short  
Figure 10. 100mA Current Limit vs. VIN

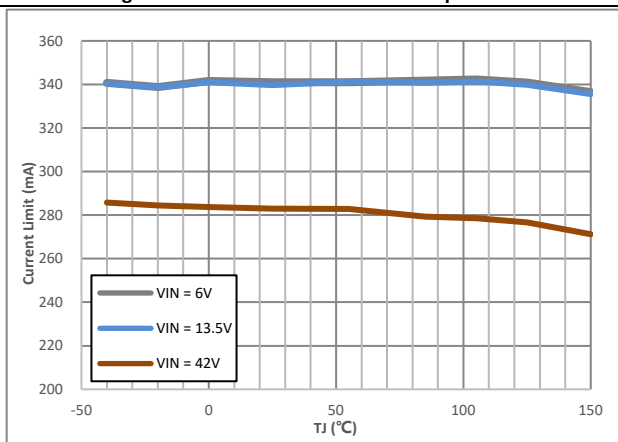

LN20542Q1, Fixed  $V_{OUT} = 5\text{V}$ , Measured at  $V_{OUT}$  short  
Figure 11. 200mA Current Limit vs. Temperature

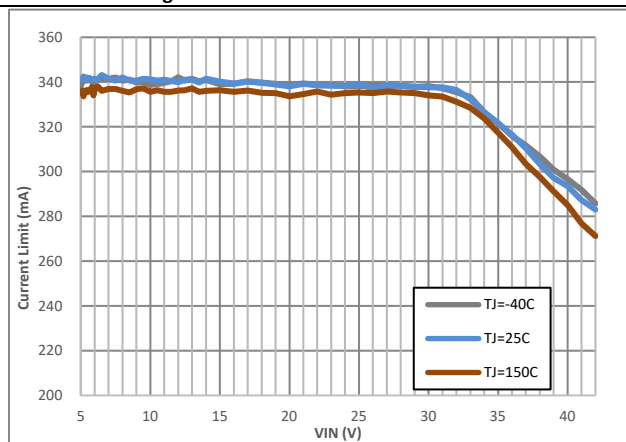

LN20052Q1, Fixed  $V_{OUT} = 5\text{V}$ , Measured at  $V_{OUT}$  short  
Figure 12. 200mA Current Limit vs. VIN

### 7.5.2 Typical Characteristics

Unless otherwise stated, the test conditions are the same as Chapter 7.4.  $T_j = -40^{\circ}\text{C}$  to  $150^{\circ}\text{C}$ .

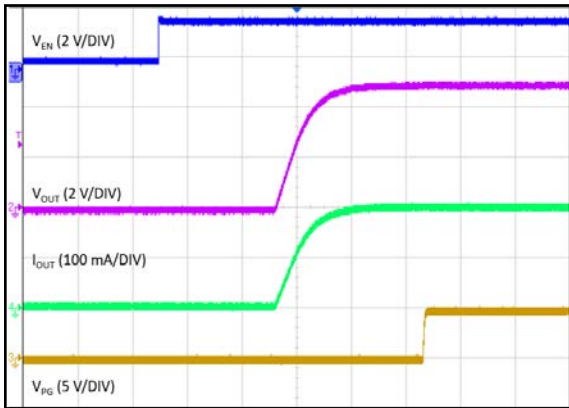

Time (100 $\mu\text{s}$ /DIV)

LN20042Q1, Adjustable  $V_{\text{OUT}} = 5\text{V}$ ,  $V_{\text{IN}} = 13.5\text{V}$ ,  $R_{\text{LOAD}} = 250\Omega$

Figure 13. Startup with EN

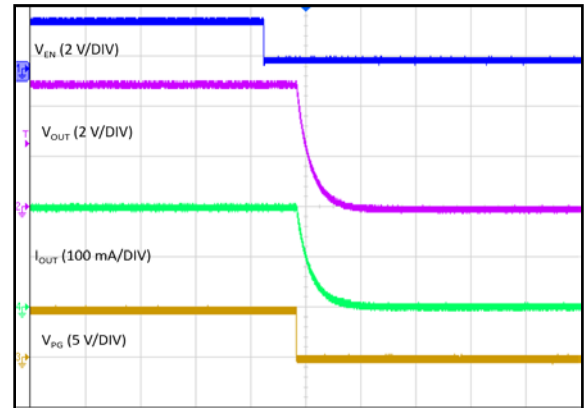

Time (100 $\mu\text{s}$ /DIV)

LN20042Q1, Adjustable  $V_{\text{OUT}} = 5\text{V}$ ,  $V_{\text{IN}} = 13.5\text{V}$ ,  $R_{\text{LOAD}} = 250\Omega$

Figure 14. Shutdown with EN

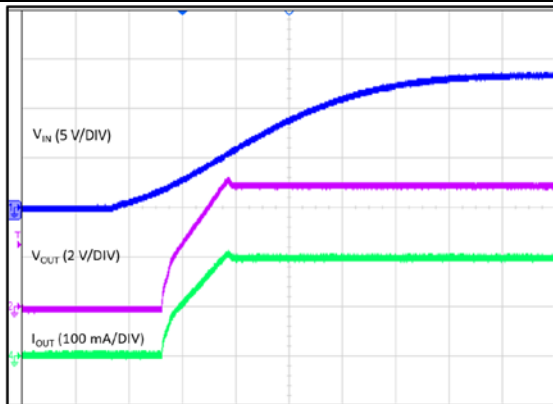

Time (2ms/DIV)

LN20042Q1, Adjustable  $V_{\text{OUT}} = 5\text{V}$ ,  $V_{\text{IN}} = 13.5\text{V}$ ,  $R_{\text{LOAD}} = 250\Omega$

Figure 15. Startup with  $V_{\text{IN}}$

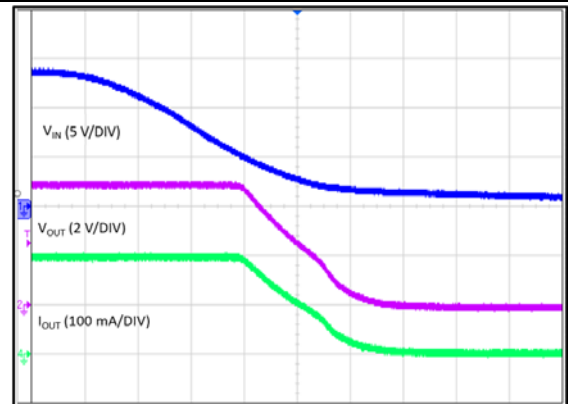

Time (2ms/DIV)

LN20042Q1, Adjustable  $V_{\text{OUT}} = 5\text{V}$ ,  $V_{\text{IN}} = 13.5\text{V}$ ,  $R_{\text{LOAD}} = 250\Omega$

Figure 16. Shutdown with  $V_{\text{IN}}$

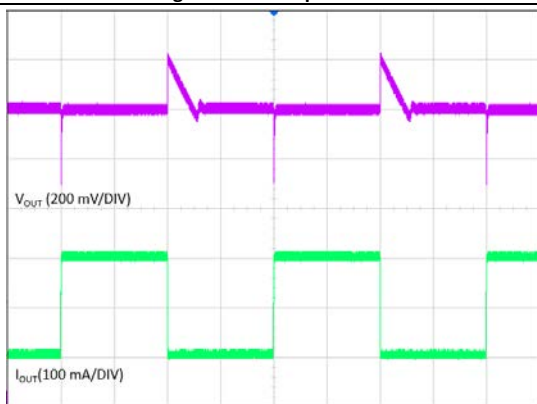

Time (5ms/DIV)

LN20442Q1, Fixed  $V_{\text{OUT}} = 5\text{V}$ ,  $V_{\text{IN}} = 13.5\text{V}$ , Slew Rate $\uparrow\downarrow = 0.1\text{A}/\mu\text{s}$

Figure 17. Load Transient 0 <-> 200mA

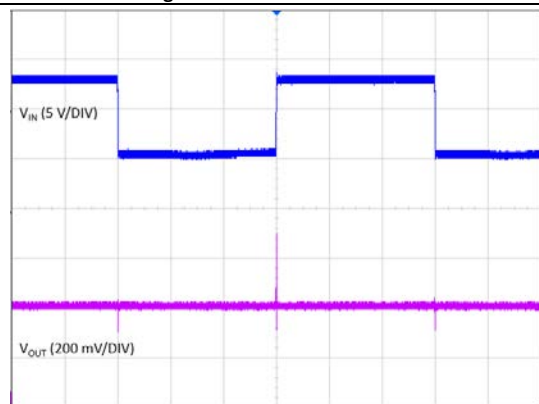

Time (1ms/DIV)

LN20442Q1, Fixed  $V_{\text{OUT}} = 5\text{V}$ ,  $I_{\text{OUT}} = 200\text{mA}$ , Slew Rate $\uparrow = 5\text{V}/\mu\text{s}$

Figure 18. Line Transient 6 <-> 13.5V

Typical Characteristics (Continued)

Unless otherwise stated, the test conditions are the same as Chapter 7.4.  $T_j = -40^{\circ}\text{C}$  to  $150^{\circ}\text{C}$ .

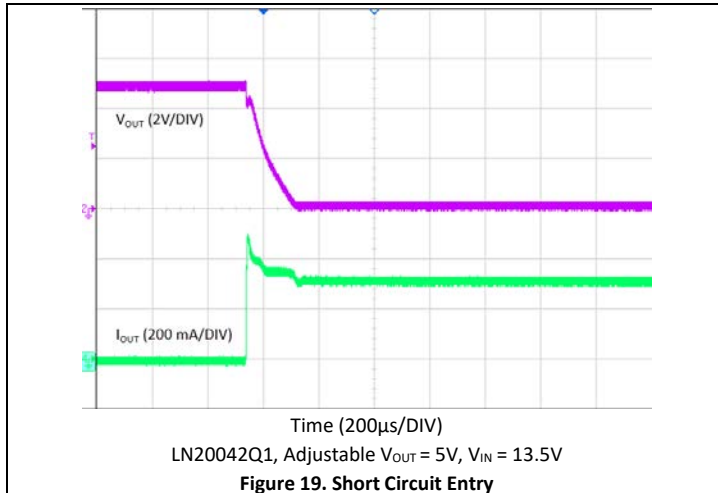

Figure 19. Short Circuit Entry

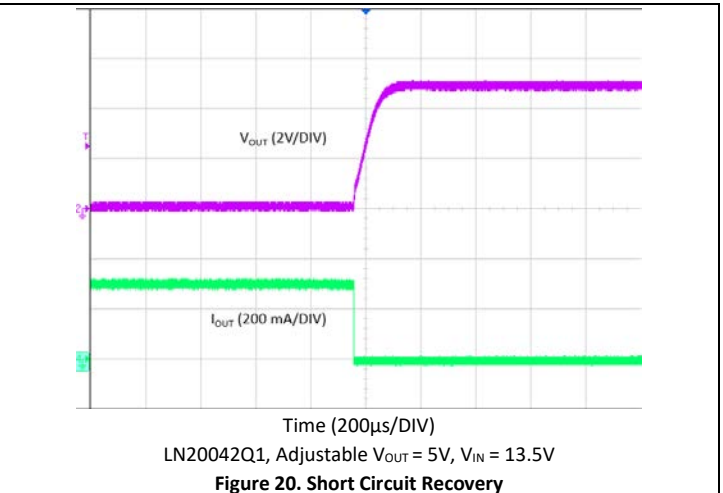

Figure 20. Short Circuit Recovery

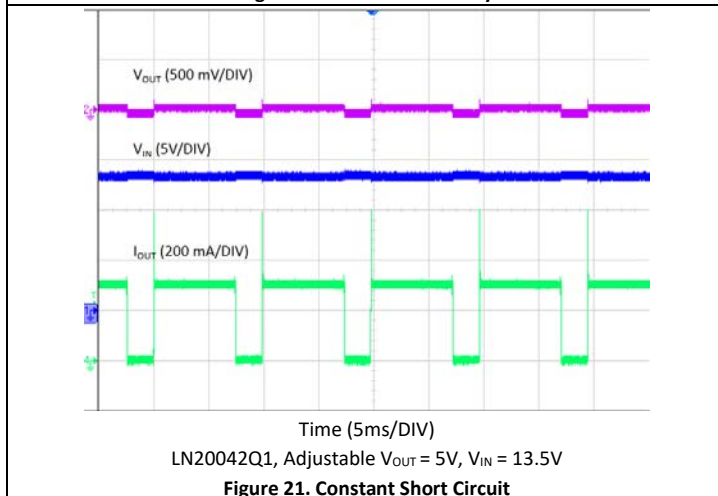

Figure 21. Constant Short Circuit

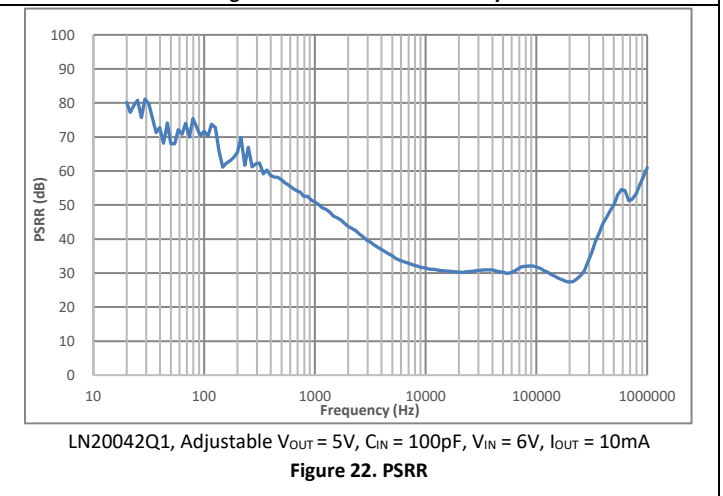

Figure 22. PSRR

## 8 FUNCTIONAL DESCRIPTION

### 8.1 Overview

LN20X42/1Q1 are ultra-low quiescent current, low dropout linear regulators (LDOs) with a wide input voltage range of 2.75V to 42V. The series provides 3.3V, 5V and 15V fixed outputs or 0.6V to 24V adjustable output, and delivers up to 100mA or 200mA output current. The shutdown current of LN20X42/1Q1 is less than 1 $\mu$ A, while the quiescent current under no-load condition is less than 5.5 $\mu$ A.

LN20X42/1Q1 provides a power good indicator with programmable DELAY pin to directly drive the reset pin of a microprocessor (MCU), moreover, there are options of highly accurate fixed output of 5V or 3.3V.

LN20X42/1Q1 features over-current protection and over-temperature shutdown with auto restart. The over-current threshold drops when the input voltage is above 28V.

The product family is available in thermally enhanced MSOP-EP8 package.

### 8.2 Functional Diagram

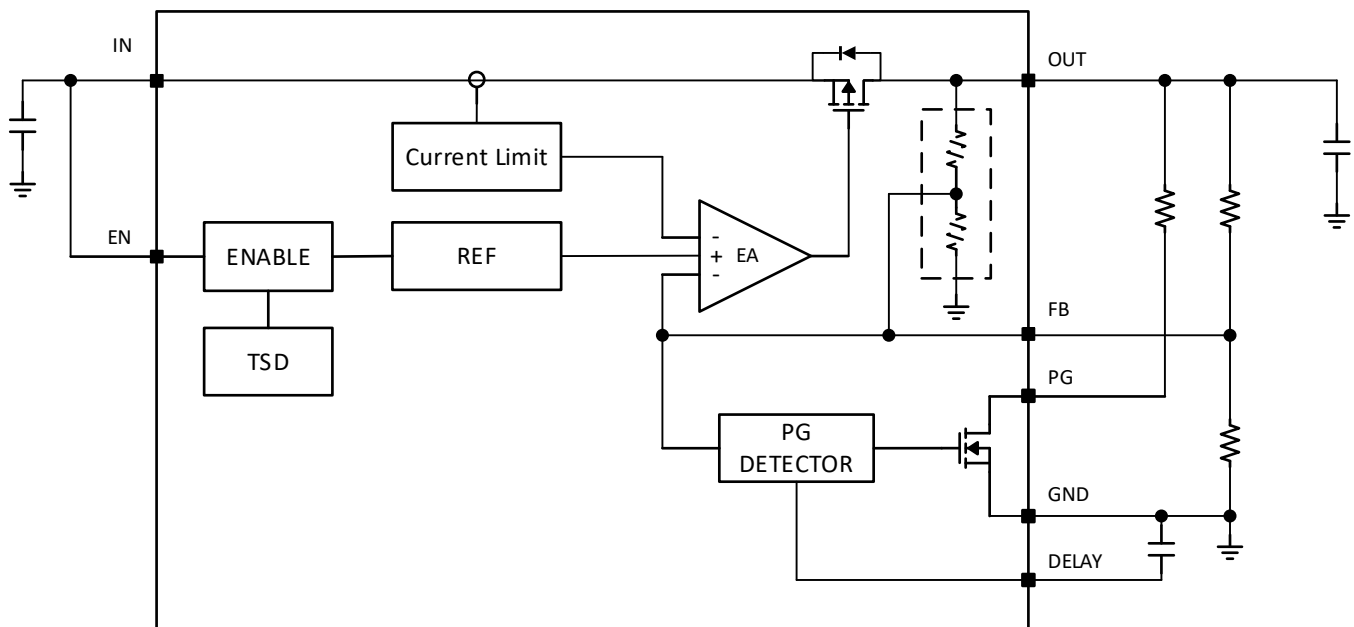

Figure 23. LN20X42/1Q1 Functional Diagram

## 9 APPLICATIONS

### 9.1 Application Diagram with Full Features

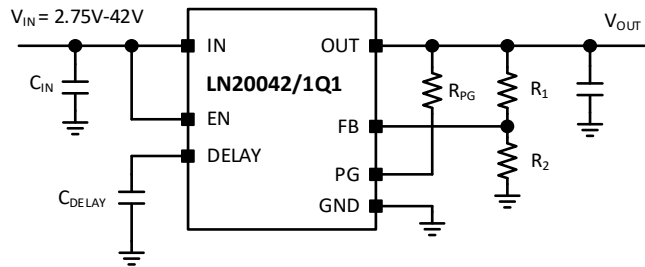

Figure 24. LN20042/1Q1 with full features

### 9.2 Minimum Application Diagram

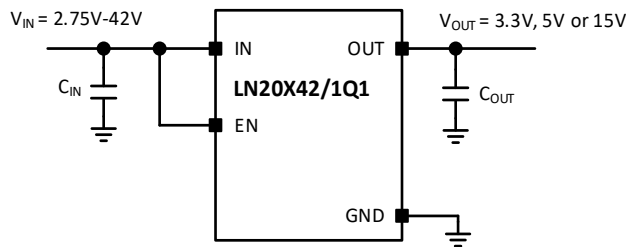

Figure 25. LN20X42/1Q1 with minimum external components

### 9.3 Application Considerations

#### 9.3.1 Input and Output Decouple Capacitors

For control loop stabilities, LN20X42/1Q1 integrates internal compensation and only requires ceramic capacitors with minimum capacitance of 1uF between VIN and GND, and VOUT and GND, respectively. It is recommended that the capacitor is placed as close to the device pins as possible with minimum PCB trace length.

#### 9.3.2 EN Pin

EN is the enable pin of the internal device supply and the output of the LDO. When the voltage on EN pin rises above the rising threshold  $V_{EN-H}$ , the LDO output is allowed; and when the voltage on EN falls below the falling threshold  $V_{EN-L}$ , the LDO output is disabled and the device goes into shutdown mode. Another way of using EN pin is connecting EN directly to the input voltage, the pin has the same maximum operating voltage of 42V as the LDO input.

#### 9.3.3 OUT and FB Pins

To adjust the output voltage, connect a voltage divider between OUT and GND, and connect the center of the divider to FB pin. The steady state  $V_{FB}$  is typically at 0.6V. The output voltage can be derived from:

$$V_{OUT} = \left(1 + \frac{R_1}{R_2}\right) \times V_{FB}$$



To fully utilize the low  $I_Q$  capability of the product family, it is recommended to use resistors with tolerance better than 1%, and with temperature coefficients less than 100ppm for the divider design. A typical selection of  $R_2$  is 1M $\Omega$ ,  $R_1$  can then be calculated from:

$$R_1 = \frac{V_{OUT} - V_{FB}}{V_{FB}} \times R_2$$

When using the fixed VOUT products, there is no external divider.

### 9.3.4 PG and DELAY Pins

The PG pin is connected to the open drain of an internal N-MOSFET. Externally, the PG pin needs to be pulled up to a voltage source by a resistor. The PG pin can directly drive the reset pin of a MCU. When EN is high and  $V_{OUT}$  rises above the power good threshold  $V_{PG-RISE}$ , the DELAY pin starts to output a current  $I_{D-Charge}$  to charge the external delay capacitor, when the voltage on the DELAY pin rises across  $V_{D-RISE}$ , PG is pulled up. The external delay capacitor is selected based on the desired MCU delay  $t_{Delay}$  and is calculated based on:

$$C_{Delay} = \frac{I_{D-Charge} \times t_{Delay}}{V_{D-Rise}}$$

## 10 PACKAGE INFORMATION

### 10.1 Package Outline

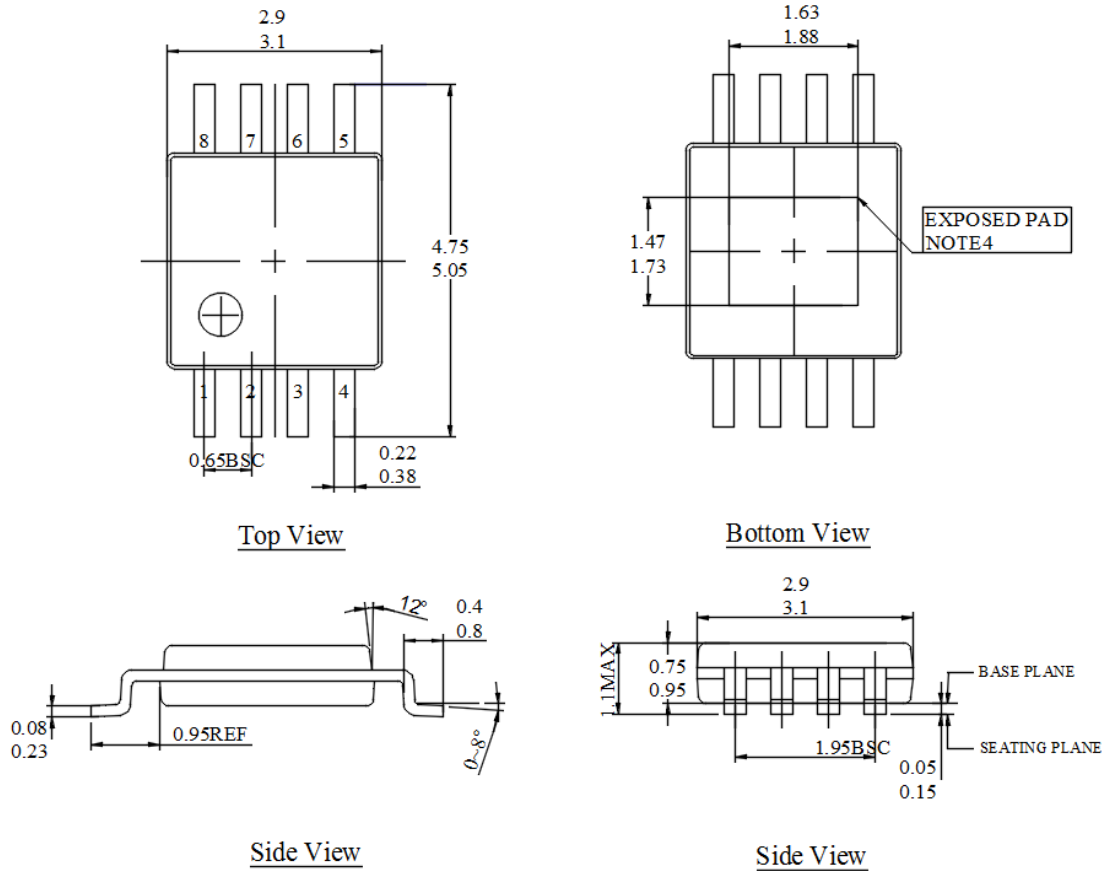

#### Notes:

1. All linear dimensions are in millimeters. Dimensioning and tolerancing per ASME Y14.5M-1994.
2. Both package length and width does not include mold flash.
3. Unremoved flash between leads & package end flash shall not exceed 0.15mm from bottom body per side.
4. Features may not present.

10.2 Footprint Example

LAND PATTERN EXAMPLE  
EXPOSED METAL SHOWN

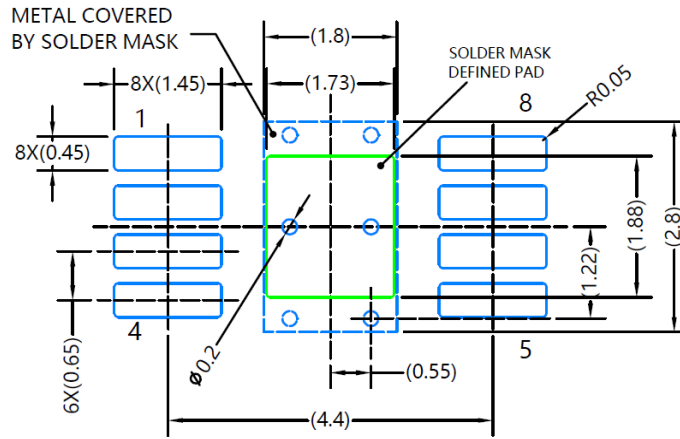

SOLDER PASTE EXAMPLE  
BASED ON 0.125 mm THICK STENCIL

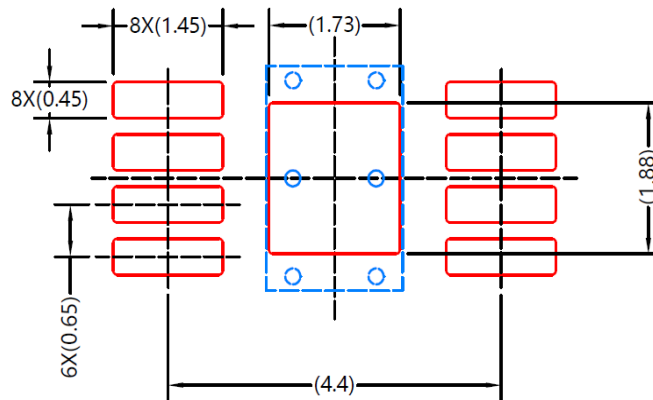

### **IMPORTANT NOTICE AND DISCLAIMERS**

The technical materials, reliability data, product specifications, and related product evaluation boards provided by LEN Technology Ltd. are on an "as is" basis. LEN Technology Ltd. is not responsible for any errors that may occur in these resources. LEN Technology Ltd. disclaims all expressed and implied warranties, including any implied warranties that the intellectual property rights of third parties will not be infringed.

These resources from LEN Technology Ltd. are provided only to those who have experience in developing electronic products. You will be solely responsible for selecting appropriate products from LEN Technology Ltd., and for verifying and testing your design to meet the standards of your application, as well as for any other safety and security requirements.

The resources provided by LEN Technology Ltd. are subject to change without notice. LEN Technology Ltd. Only grants you the rights for developing applications with the products of LEN Technology Ltd. described in these resources. Reproduction and display of these resources is prohibited. LEN Technology Ltd. does not grant any other intellectual property rights owned by LEN Technology Ltd. or any third-party licensed intellectual property. LEN Technology Ltd. does not assume any loss, cost and liabilities for the use of these resources.

### **ENVIRONMENTAL DECLARATION**

This product complies with the requirements of RoHS and REACH. In accordance with relevant Chinese regulations and standards, it does not contain toxic or harmful substances or elements.

单击下面可查看定价，库存，交付和生命周期等信息

[>>LEN](#)