

Amphenol

GEC | Amphenol
TPI



USCM SERIES

USCM (Ultra Sealed Connector, Multiple Poles) is a high-grade sealed connector series to meet outdoor long-term use under harsh environment conditions; providing users a highly reliable electrical interconnection solution. USCM delivers the highest standard of electrical and mechanical performance ensuring commercial vehicles and off-road equipment runs safer, cleaner and more intelligent.

USCM is a cost-effective connector series incorporating thermoplastic housings, silicone rubber seals and stamped contacts which delivers superior performance. The rugged construction and design ensure safe and reliable signal transmission and power supply for vehicles and industrial equipment in harsh environments.

The design of the USCM series adopts individual sealing plugs to achieve excellent environmental sealing. The plug and receptacle each consist of a housing and contact locating cover. the series is available in two color options (black or gray) with a variety of securement/routing accessories. contact locating covers are used to ensure that the contact is aligned and accurately seated inside the connector housing; in addition, the plug locating cover offers enhanced sealing retention features to secure the interface seals to provide rugged sealing assurance and durability (IP67, IP6K9K, IP68 & Air-Tight). The plug features integral latch-style mating that provides tactile and audible feedback during mating. An integrated V-groove on all receptacles accepts various cable mounting accessories.

USCM connectors are available in 4 housing sizes with 4 mechanical keying options, they are offered in arrangements ranging from 2 to 25 poles, the series provides a solution for high vibration resistance and high mechanical-shock resistance (GB/T-28046 & QC/T 1067, V3 – commercial vehicle engine and transmission applications).

Key Features

- 48V rating, HV version provides up to a 250V rating;
- Thermoplastic connectors shells;
- Individual sealing plugs waterproof design;
- Wide arrangements ranging from 2 to 25 poles;
- 4 mechanical keying options, X/Y/Z/U-Keying;
- Accepts contact size #12 (Max. 30A/13A);
- Minimum 200 mating cycles for stamped contacts;
- Cable Range: 24-12 AWG (0.35mm² - 4.0mm²)
- Operating Temp: -55°C to +125 °C
- IP67, IP68, and IP6K9K, 48Kpa Air-tight(when mated);
- Jam-Nut and Cable-to-Cable installation methods;
- Locating cover design offers enhanced sealing retention features



Plug locating cover with enhanced retention features

Technical Overview

Current Rating	Up to 13A@16# contacts, 30A@12# contacts
Operation Voltage	48V AC/DC, up to 250V AC/DC* (HV applications)
Cable Range	24- 12 AWG (0.35mm ² - 4. 0mm ²)
	Insulator diameter ranges: #16: Ø1.2mm to 2. 40mm #12: Ø1.5mm to 3. 70mm
Operating Temp	-55°C to +125°C
Durability	Minimum 200 mating cycles
Waterproof	IP67, IP68 (1meter, 24H), IP6K9K
Flammability	UL 94 V-0
Dielectric Voltage	1500V ac for 60 s
Thermal Shock	-55°C to +125°C, 20 cycles
Physical Shock	50g's peak, 3axes, 11millisecond duration half-sine pulse, no loss of continuity >1µsec
Vibration	Ref. SAE J2030_201506 No unlocking or un-mating and exhibits no mechanical or physical damage after sinusoidal vibration levels of 20 G's at 10 to 2000 Hz in each of the three mutually perpendicular planes. No electrical discontinuities longer than 1µsec
	Ref. GB/T 28046.3 4.2.1.6. Sinusoidal vibration: a _{max} = 120m/s ² , 94h for each of the 3 axes; Random vibration: a _{max} = 177 m/s ² , 94h for each of the 3 axes; There must be no loss of electrical continuity for more than 1 microsecond. If one or more terminal pairs are monitored, rather than the series resistor, there must be no instance in which the resistance of any terminal pair exceeds 7.0 Ω for more than 1 microsecond
Salt Spray	96 H
Air-Tight	Pressure with 48kPa and keep 15s, no leakage
Temp. Endurance	1008H at 125°C, Insulation Resistance >100MΩ
Moisture Resistance	Ref. IEC60068-2-78, RH90-95%,40°C, 504 H; Insulation Resistance > 100MΩ
Humidity Steady	Ref. QC/T-1067.1, 10 Cycles; Insulation Resistance > 100MΩ



Product Material

Housing	Thermoplastic, Glass filled PA
Seals	Silicone Rubber
Locating Cover	PBT+GF
Secondary Lock	Thermoplastic, Glass filled PA
Contact	Copper alloy & stainless steel Nickel, or gold flash plating

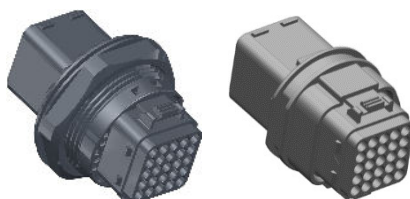

* High-voltage applications, further information available upon request

Product Exploded View

Cable-to-Cable Solution

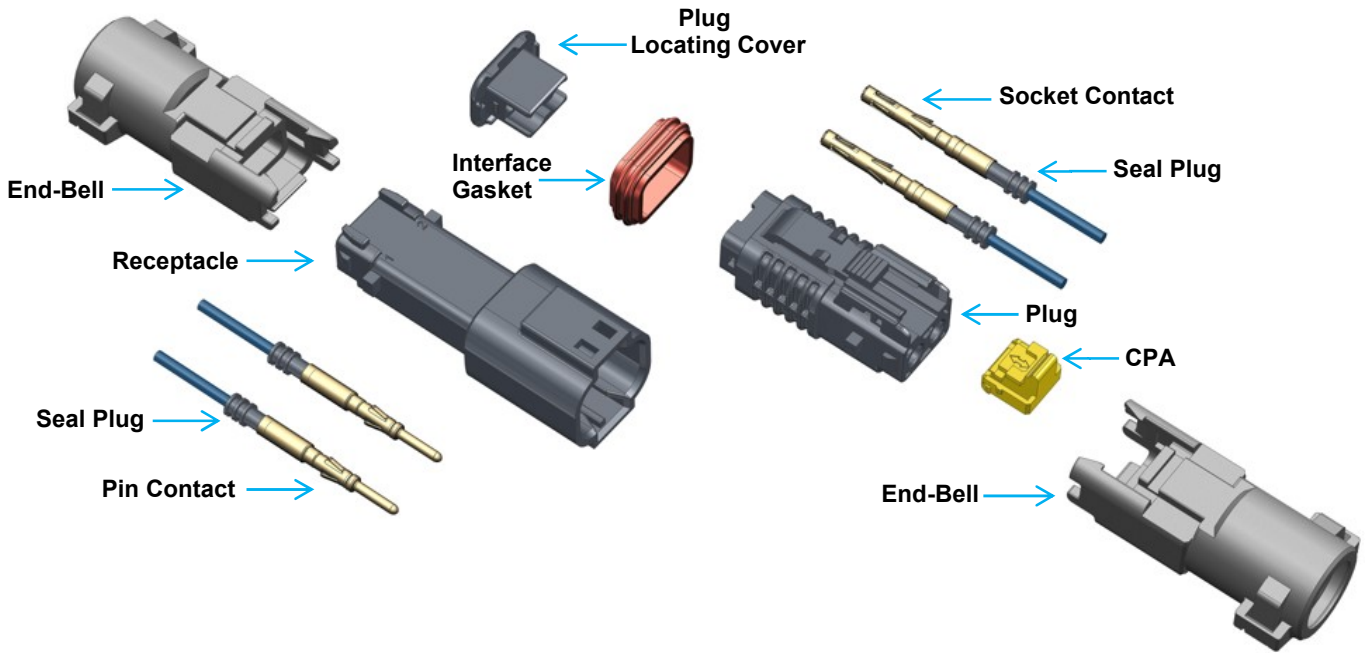

Jam-Nut Solution

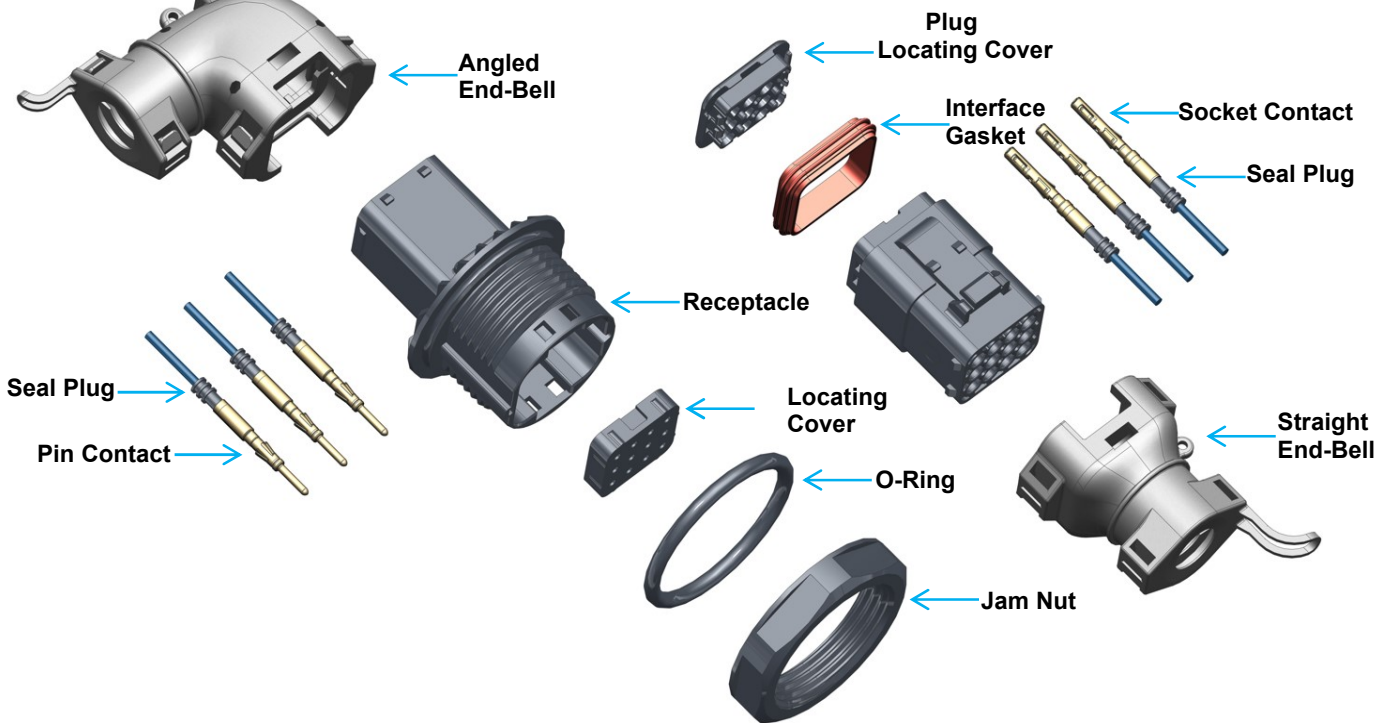

High Vibration-Resistance Solution

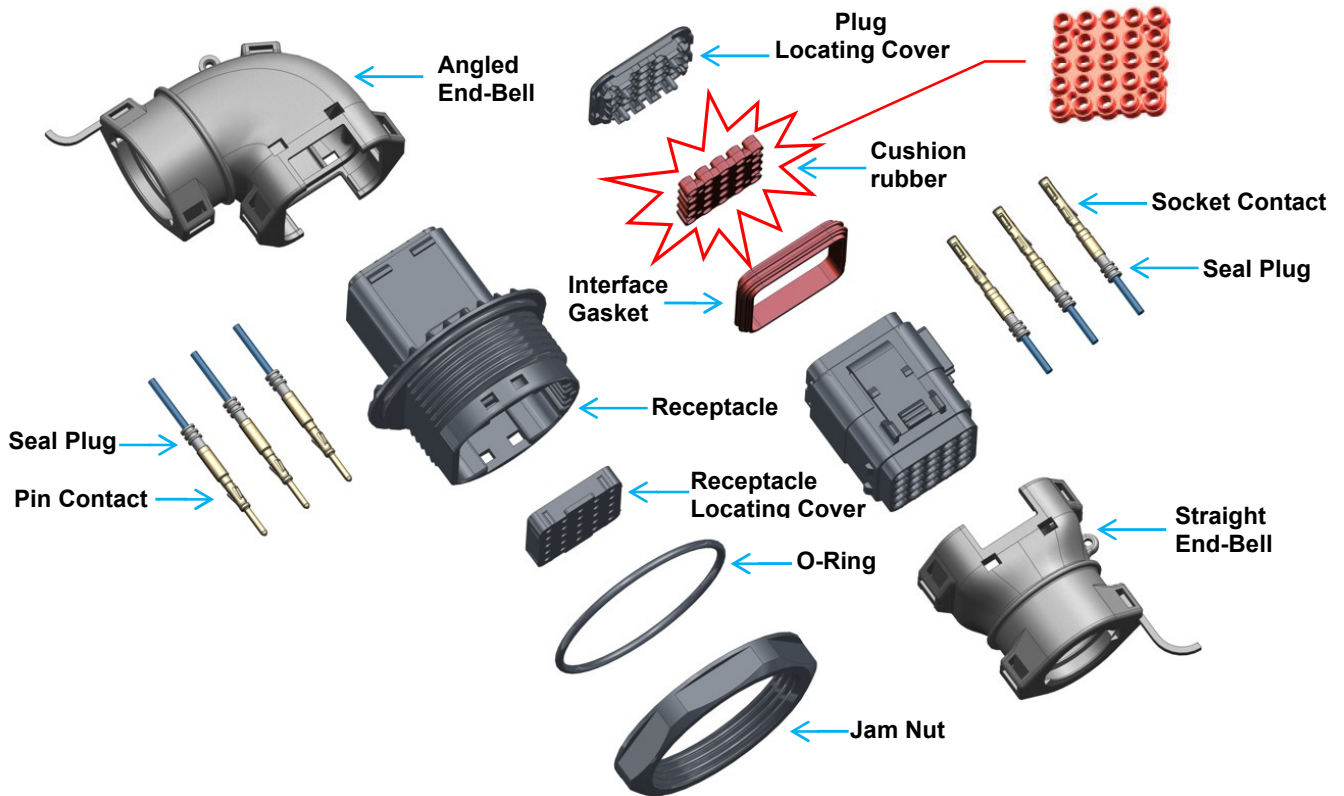

- ❖ Designed with an anti-vibration cushion at front of the Plug;
- ❖ Meet the QC/T 1067, GB/T 28046.3, V3 grade vibration resistance;
- ❖ Sine-Vibration: Peak acceleration up to 25G, duration=94H/axis (x/y/z);
- ❖ Random-Vibration: acceleration (r. m. s) =177m/s²; duration=94H/axis(x/y/z);

Mechanical Keying

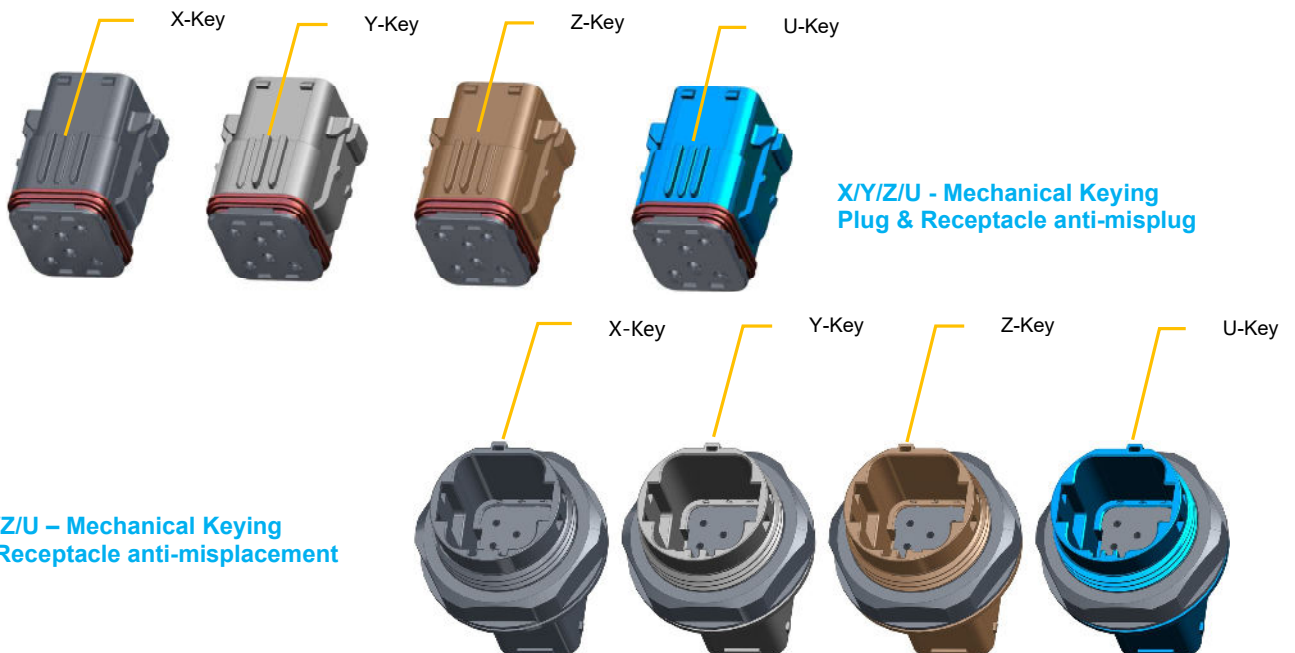

Target Market

- **Heavy Equipment**
 - Truck
 - Bus
- **Off-Road Vehicle & Equipment**
 - Construction
 - Mining
 - Agriculture
- **Industrial**
 - Factory equipment & Robotics
 - Outdoor Electronics

Applications

- 48V Systems
- Engine & Transmission Harnessing
- Lighting
- Control Units
- Signal Interfaces
- Cabin Harness & Accessories
- Vehicle Seat & Brand Logo
- Wipers/under hood electronics
- LCD displays & accessories
- Sensors (Electrical, Pressure, Temperature)



Heavy Truck



Bus



Tractor



Agriculture



Construction



Off-Road



Outdoor Electronics



Robotics



Factory Equipment

How To Order

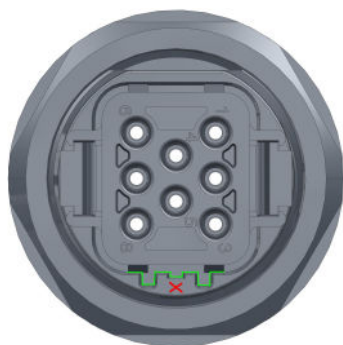
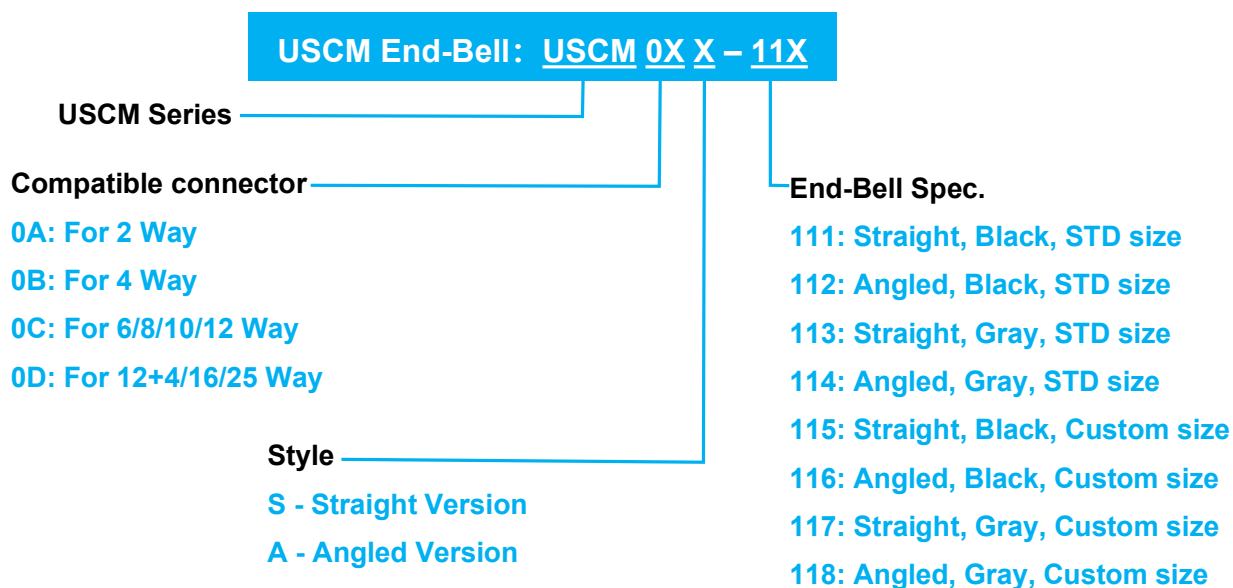
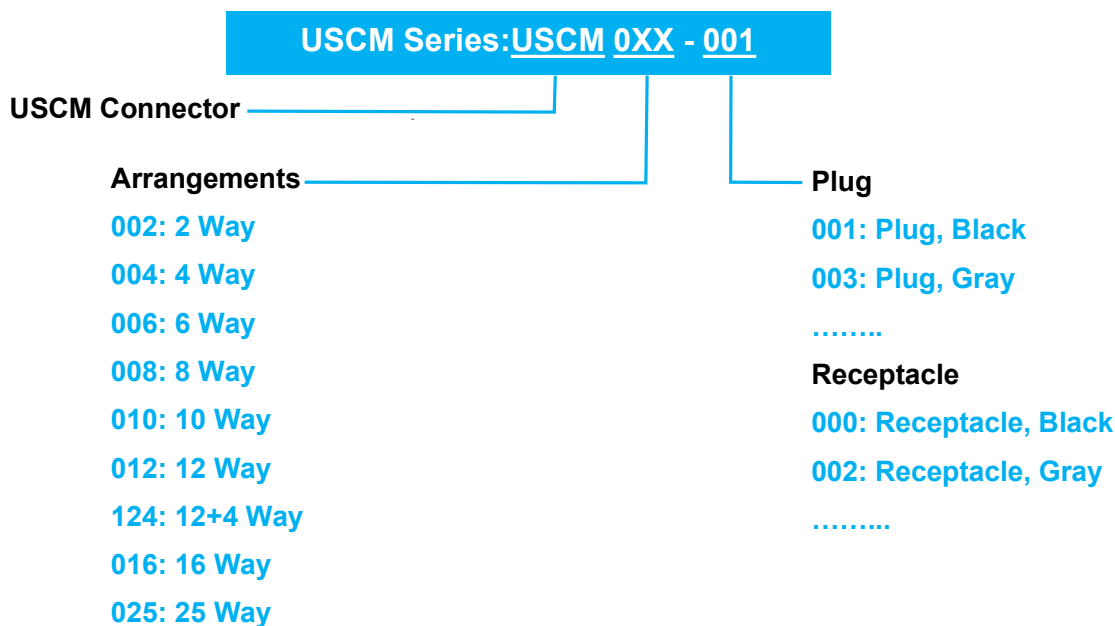

X-Keying*

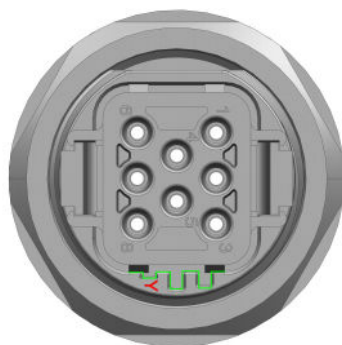

Y-Keying*

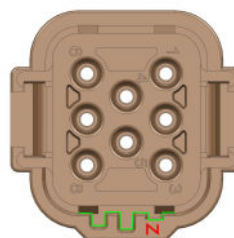

Z-Keying*

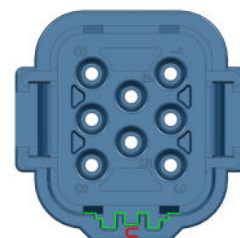

U-Keying*

- * 4 housing sizes with 4 mechanical keying options
- * Jam-Nut & Cable-to-Cable versions for each layout

USCM Series Layouts



2 Way=2*#16

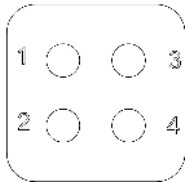

4 Way=4*#16

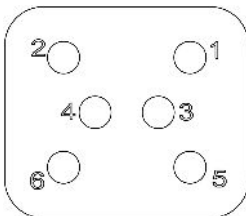

6 Way=6*#16

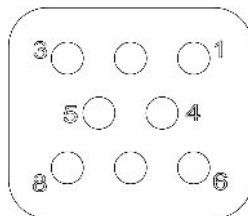

8 Way=8*#16

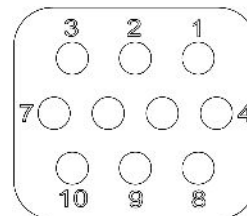

10 Way=10*#16

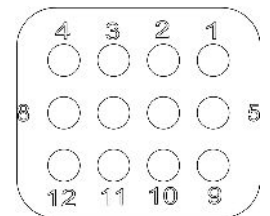

12 Way=12*#16

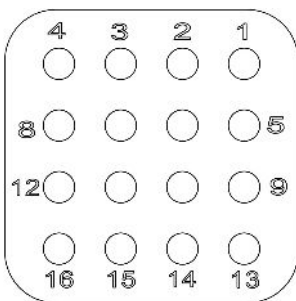

16 Way=16*#16

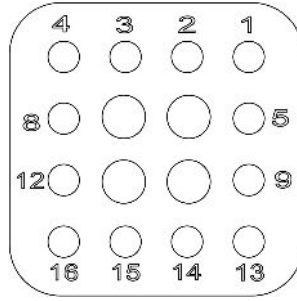

12+4 Way=12*#16+4*#12

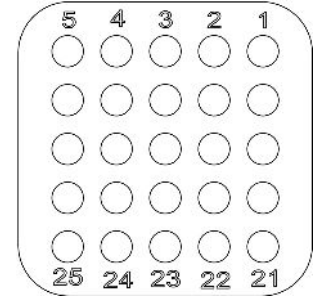

25 Way=25*#16



Jam-Nut Version

Cable-to-Cable Version

USCM Series

2Way-Plugs



Keying	Color	Part Number	Description
X - Key	Black	USCM002-101	2 Way Plug, X-Key, Black
	Gray	USCM002-111	2 Way Plug, X-Key, Gray
Y - Key	Black	USCM002-103	2 Way Plug, Y-Key, Black
	Gray	USCM002-133	2 Way Plug, Y-Key, Gray
Z - Key	Black	USCM002-105	2 Way Plug, Z-Key, Black
	Gray	USCM002-155	2 Way Plug, Z-Key, Gray
U - Key	Black	USCM002-107	2 Way Plug, U-Key, Black
	Gray	USCM002-177	2 Way Plug, U-Key, Gray

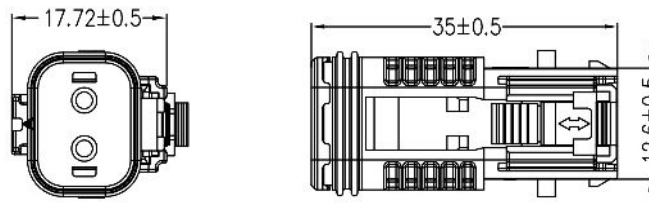

Key Features

- ◆ 2 Way Plugs, signaling connectors, Current rating: Max.13A
- ◆ 4 mechanical keying options - X/Y/Z/U, 2 color options: black or gray
- ◆ Accepts contact size #16, refer to page 26 for contact selections
- ◆ IP67, IP68, and IP6K9K, 48Kpa Air-tight (when mated)
- ◆ Flammability: UL94 V-0
- ◆ Accessories include back-shells, dust-caps, seal plugs, mounting clips. refer to page 28-31

USCM Series 2Way Receptacles

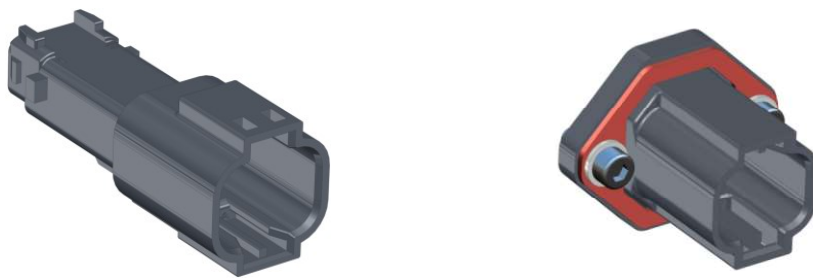

Keying	Color	Part Number	Description
X- Key	Black	USCM002-002	2 Way Cable-to-Cable Receptacle, X-Key, BK
	Gray	USCM002-022	2 Way Cable-to-Cable Receptacle, X-Key, GY
	Black	USCM002-302	2 Way Flange Receptacle, X-Key, BK
	Gray	USCM002-322	2 Way Flange Receptacle, X-Key, GY
Y- Key	Black	USCM002-004	2 Way Cable-to-Cable Receptacle, Y-Key, BK
	Gray	USCM002-044	2 Way Cable-to-Cable Receptacle, Y-Key, GY
	Black	USCM002-304	2 Way Flange Receptacle, Y-Key, BK
	Gray	USCM002-344	2 Way Flange Receptacle, Y-Key, GY
Z- Key	Black	USCM002-006	2 Way Cable-to-Cable Receptacle, Z-Key, BK
	Gray	USCM002-066	2 Way Cable-to-Cable Receptacle, Z-Key, GY
	Black	USCM002-306	2 Way Flange Receptacle, Z-Key, BK
	Gray	USCM002-366	2 Way Jam-Nut Receptacle, Z-Key, GY
U- Key	Black	USCM002-008	2 Way Cable-to-Cable Receptacle, U-Key, BK
	Gray	USCM002-088	2 Way Cable-to-Cable Receptacle, U-Key, GY
	Black	USCM002-308	2 Way Flange Receptacle, U-Key, BK
	Gray	USCM002-388	2 Way Flange Receptacle, U-Key, GY

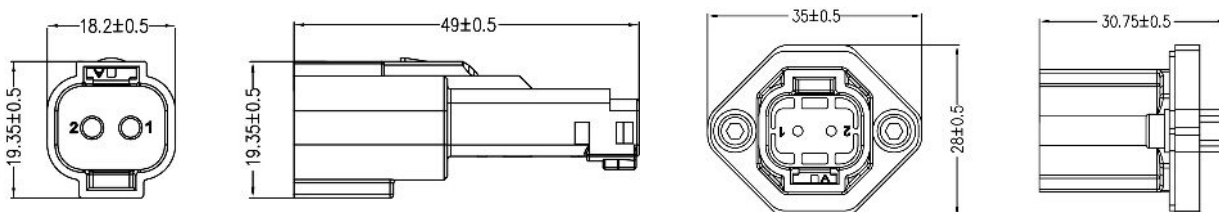

Key Features

- ◆ 2 Way Receptacles, signaling connectors, Current rating: Max.13
- ◆ Flange or Cable-to-Cable installation methods
- ◆ 4 mechanical keying options - X/Y/Z/U, 2 color options
- ◆ Accepts contact size #16, refer to page 26 for contact selections
- ◆ IP67, IP68, and IP6K9K, 48Kpa Air-tight (when mated)
- ◆ Flammability: UL94 V-0
- ◆ Accessories include back-shells, dust-caps, seal plugs, mounting clips. refer to page 28-31

Specifications and dimensions subject to change

USCM Series 4Way Plugs

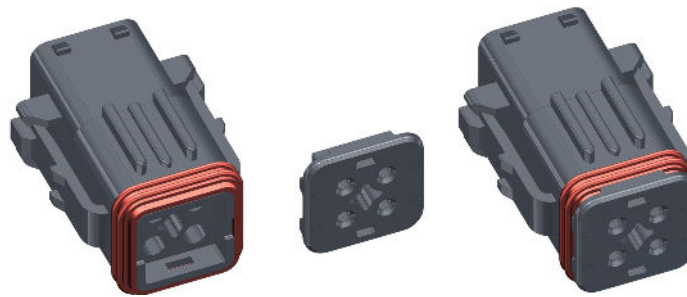

Keying	Color	Part Number	Description
X - Key	Black	USCM004-005	4 Way Plug, X-Key, Black
	Gray	USCM004-007	4 Way Plug, X-Key, Gray
Y - Key	Black	USCM004-009	4 Way Plug, Y-Key, Black
	Gray	USCM004-011	4 Way Plug, Y-Key, Gray
Z - Key	Black	USCM004-013	4 Way Plug, Z-Key, Black
	Gray	USCM004-015	4 Way Plug, Z-Key, Gray
U - Key	Black	USCM004-017	4 Way Plug, U-Key, Black
	Gray	USCM004-019	4 Way Plug, U-Key, Gray

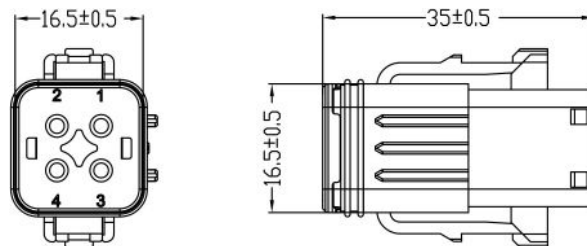

Key Features

- ◆ 4 Way Plugs, signaling connectors, Current rating: Max.13A
- ◆ 4 mechanical keying options - X/Y/Z/U, 2 color options: black or gray
- ◆ Accepts contact size #16, refer to page 26 for contact selections
- ◆ IP67, IP68, and IP6K9K, 48Kpa Air-tight (when mated)
- ◆ Flammability: UL94 V-0
- ◆ Accessories include back-shells, dust-caps, seal plugs, mounting clips. refer to page 28-31

USCM Series

4Way Receptacles

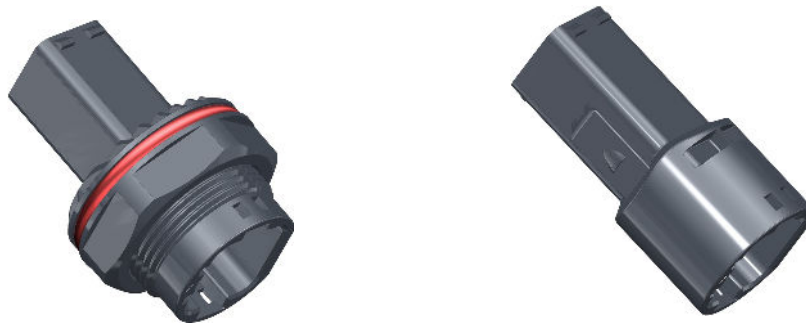

Keying	Color	Part Number	Description
X- Key	Black	USCM004-004	4 Way Jam-Nut Receptacle, X-Key, BK
	Gray	USCM004-006	4 Way Jam-Nut Receptacle, X-Key, GY
	Black	USCM004-104	4 Way Cable-to-Cable Receptacle, X-Key, BK
	Gray	USCM004-106	4 Way Cable-to-Cable Receptacle, X-Key, GY
Y- Key	Black	USCM004-008	4 Way Jam-Nut Receptacle, Y-Key, BK
	Gray	USCM004-010	4 Way Jam-Nut Receptacle, Y-Key, GY
	Black	USCM004-108	4 Way Cable-to-Cable Receptacle, Y-Key, BK
	Gray	USCM004-110	4 Way Cable-to-Cable Receptacle, Y-Key, GY
Z- Key	Black	USCM004-012	4 Way Jam-Nut Receptacle, Z-Key, BK
	Gray	USCM004-014	4 Way Jam-Nut Receptacle, Z-Key, GY
	Black	USCM004-112	4 Way Cable-to-Cable Receptacle, Z-Key, BK
	Gray	USCM004-114	4 Way Cable-to-Cable Receptacle, Z-Key, GY
U- Key	Black	USCM004-016	4 Way Jam-Nut Receptacle, U-Key, BK
	Gray	USCM004-018	4 Way Jam-Nut Receptacle, U-Key, GY
	Black	USCM004-116	4 Way Cable-to-Cable Receptacle, U-Key, BK
	Gray	USCM004-118	4 Way Cable-to-Cable Receptacle, U-Key, GY

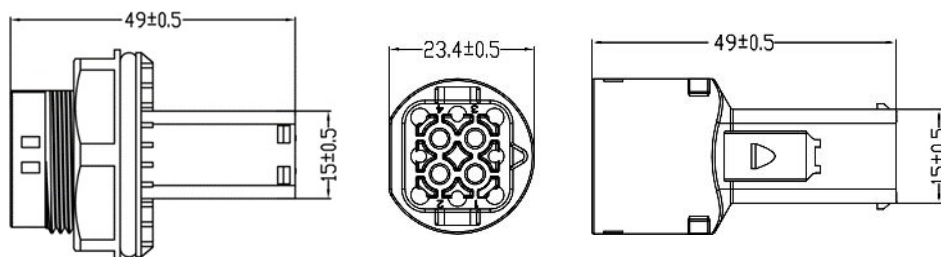

Key Features

- ◆ 4 Way Receptacles, signaling connectors, Current rating: Max.13
- ◆ Jam-Nut or Cable-to-Cable installation methods
- ◆ 4 mechanical keying options - X/Y/Z/U, 2 color options
- ◆ Accepts contact size #16, refer to page 26 for contact selections
- ◆ IP67, IP68, and IP6K9K, 48Kpa Air-tight (when mated)
- ◆ Flammability: UL94 V-0
- ◆ Accessories include back-shells, dust-caps, seal plugs, mounting clips. refer to page 28-31

Specifications and dimensions subject to change

USCM Series

6Way Plugs



Keying	Color	Part Number	Description
X - Key	Black	USCM006-005	6 Way Plug, X-Key, Black
	Gray	USCM006-007	6 Way Plug, X-Key, Gray
Y - Key	Black	USCM006-009	6 Way Plug, Y-Key, Black
	Gray	USCM006-011	6 Way Plug, Y-Key, Gray
Z - Key	Black	USCM006-013	6 Way Plug, Z-Key, Black
	Gray	USCM006-015	6 Way Plug, Z-Key, Gray
U - Key	Black	USCM006-017	6 Way Plug, U-Key, Black
	Gray	USCM006-019	6 Way Plug, U-Key, Gray

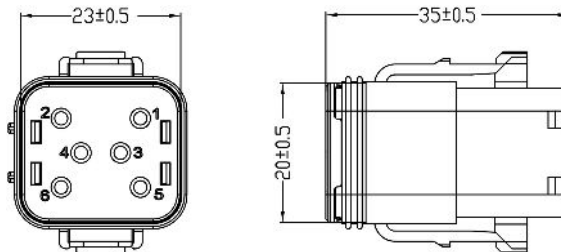

Key Features

- ◆ 6 Way Plugs, signaling connectors, Current rating: Max.13A
- ◆ 4 mechanical keying options - X/Y/Z/U, 2 color options: black or gray
- ◆ Accepts contact size #16, refer to page 26 for contact selections
- ◆ IP67, IP68, and IP6K9K, 48Kpa Air-tight (when mated)
- ◆ Flammability: UL94 V-0
- ◆ Accessories include back-shells, dust-caps, seal plugs, mounting clips. refer to page 28-31

USCM Series 6Way Receptacles



Keying	Color	Part Number	Description
X- Key	Black	USCM006-004	6 Way Jam-Nut Receptacle, X-Key, BK
	Gray	USCM006-006	6 Way Jam-Nut Receptacle, X-Key, GY
	Black	USCM006-104	6 Way Cable-to-Cable Receptacle, X-Key, BK
	Gray	USCM006-106	6 Way Cable-to-Cable Receptacle, X-Key, GY
Y- Key	Black	USCM006-008	6 Way Jam-Nut Receptacle, Y-Key, BK
	Gray	USCM006-010	6 Way Jam-Nut Receptacle, Y-Key, GY
	Black	USCM006-108	6 Way Cable-to-Cable Receptacle, Y-Key, BK
	Gray	USCM006-110	6 Way Cable-to-Cable Receptacle, Y-Key, GY
Z- Key	Black	USCM006-012	6 Way Jam-Nut Receptacle, Z-Key, BK
	Gray	USCM006-014	6 Way Jam-Nut Receptacle, Z-Key, GY
	Black	USCM006-112	6 Way Cable-to-Cable Receptacle, Z-Key, BK
	Gray	USCM006-114	6 Way Cable-to-Cable Receptacle, Z-Key, GY
U- Key	Black	USCM006-016	6 Way Jam-Nut Receptacle, U-Key, BK
	Gray	USCM006-018	6 Way Jam-Nut Receptacle, U-Key, GY
	Black	USCM006-116	6 Way Cable-to-Cable Receptacle, U-Key, BK
	Gray	USCM006-118	6 Way Cable-to-Cable Receptacle, U-Key, GY

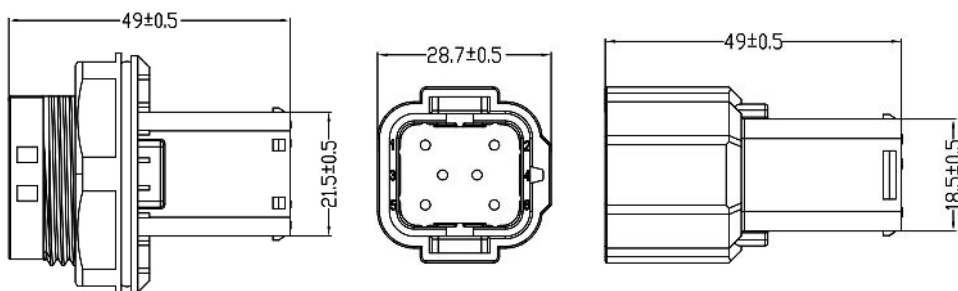

Key Features

- ◆ 6 Way Receptacles, signaling connectors, Current rating: Max.13
- ◆ Jam-Nut or Cable-to-Cable installation methods
- ◆ 4 mechanical keying options - X/Y/Z/U, 2 color options
- ◆ Accepts contact size #16, refer to page 26 for contact selections
- ◆ IP67, IP68, and IP6K9K, 48Kpa Air-tight (when mated)
- ◆ Flammability: UL94 V-0
- ◆ Accessories include back-shells, dust-caps, seal plugs, mounting clips. refer to page 28-31

Specifications and dimensions subject to change

USCM Series 8Way Plugs



Keying	Color	Part Number	Description
X - Key	Black	USCM008-005	8 Way Plug, X-Key, Black
	Gray	USCM008-007	8 Way Plug, X-Key, Gray
Y - Key	Black	USCM008-009	8 Way Plug, Y-Key, Black
	Gray	USCM008-011	8 Way Plug, Y-Key, Gray
Z - Key	Black	USCM008-013	8 Way Plug, Z-Key, Black
	Gray	USCM008-015	8 Way Plug, Z-Key, Gray
U - Key	Black	USCM008-017	8 Way Plug, U-Key, Black
	Gray	USCM008-019	8 Way Plug, U-Key, Gray

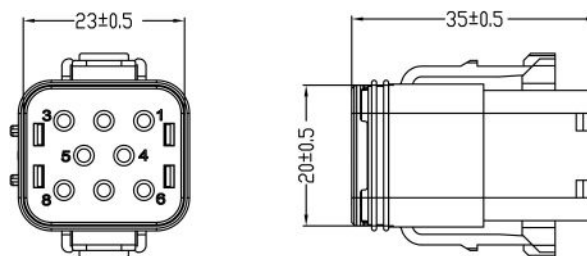

Key Features

- ◆ 8 Way Plugs, signaling connectors, Current rating: Max.13A
- ◆ 4 mechanical keying options - X/Y/Z/U, 2 color options: black or gray
- ◆ Accepts contact size #16, refer to page 26 for contact selections
- ◆ IP67, IP68, and IP6K9K, 48Kpa Air-tight (when mated)
- ◆ Flammability: UL94 V-0
- ◆ Accessories include back-shells, dust-caps, seal plugs, mounting clips. refer to page 28-31

USCM Series 8Way Receptacles

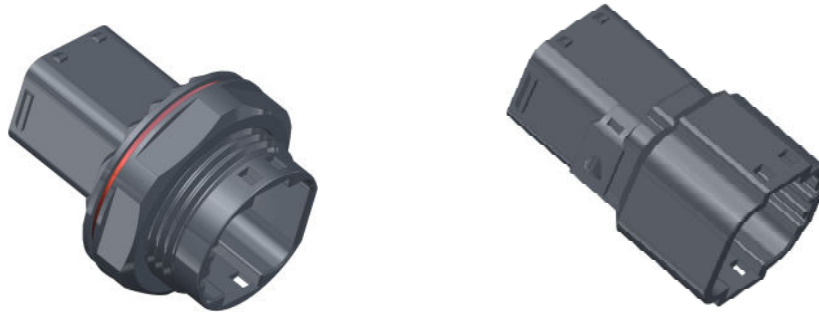

Keying	Color	Part Number	Description
X- Key	Black	USCM008-004	8 Way Jam-Nut Receptacle, X-Key, BK
	Gray	USCM008-006	8 Way Jam-Nut Receptacle, X-Key, GY
	Black	USCM008-104	8 Way Cable-to-Cable Receptacle, X-Key, BK
	Gray	USCM008-106	8 Way Cable-to-Cable Receptacle, X-Key, GY
Y- Key	Black	USCM008-008	8 Way Jam-Nut Receptacle, Y-Key, BK
	Gray	USCM008-010	8 Way Jam-Nut Receptacle, Y-Key, GY
	Black	USCM008-108	8 Way Cable-to-Cable Receptacle, Y-Key, BK
	Gray	USCM008-110	8 Way Cable-to-Cable Receptacle, Y-Key, GY
Z- Key	Black	USCM008-012	8 Way Jam-Nut Receptacle, Z-Key, BK
	Gray	USCM008-014	8 Way Jam-Nut Receptacle, Z-Key, GY
	Black	USCM008-112	8 Way Cable-to-Cable Receptacle, Z-Key, BK
	Gray	USCM008-114	8 Way Cable-to-Cable Receptacle, Z-Key, GY
U- Key	Black	USCM008-016	8 Way Jam-Nut Receptacle, U-Key, BK
	Gray	USCM008-018	8 Way Jam-Nut Receptacle, U-Key, GY
	Black	USCM008-116	8 Way Cable-to-Cable Receptacle, U-Key, BK
	Gray	USCM008-118	8 Way Cable-to-Cable Receptacle, U-Key, GY

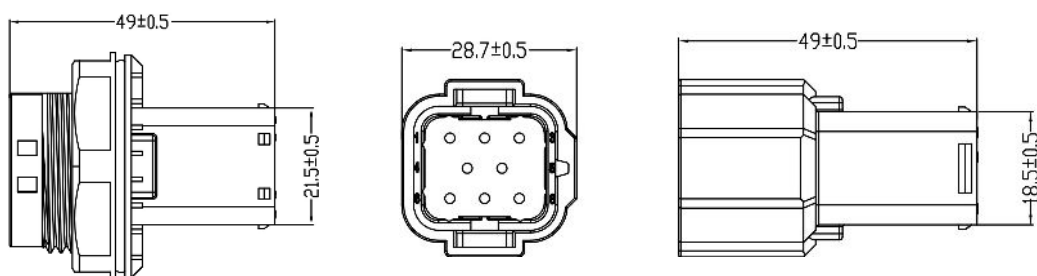

Key Features

- ◆ 8 Way Receptacles, signaling connectors, Current rating: Max.13
- ◆ Jam-Nut or Cable-to-Cable installation methods
- ◆ 4 mechanical keying options - X/Y/Z/U, 2 color options
- ◆ Accepts contact size #16, refer to page 26 for contact selections
- ◆ IP67, IP68, and IP6K9K, 48Kpa Air-tight (when mated)
- ◆ Flammability: UL94 V-0
- ◆ Accessories include back-shells, dust-caps, seal plugs, mounting clips. refer to page 28-31

Specifications and dimensions subject to change

USCM Series 10 Way Plugs



Keying	Color	Part Number	Description
X - Key	Black	USCM010-005	10 Way Plug, X-Key, Black
	Gray	USCM010-007	10 Way Plug, X-Key, Gray
Y - Key	Black	USCM010-009	10 Way Plug, Y-Key, Black
	Gray	USCM010-011	10 Way Plug, Y-Key, Gray
Z - Key	Black	USCM010-013	10 Way Plug, Z-Key, Black
	Gray	USCM010-015	10 Way Plug, Z-Key, Gray
U - Key	Black	USCM010-017	10 Way Plug, U-Key, Black
	Gray	USCM010-019	10 Way Plug, U-Key, Gray

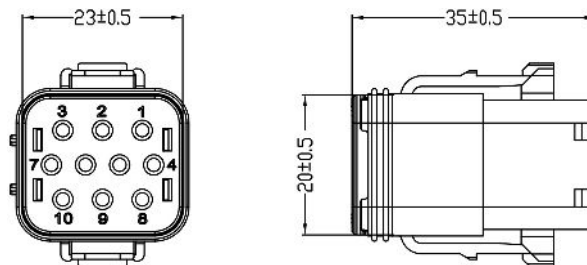

Key Features

- ◆ 10 Way Plugs, signaling connectors, Current rating: Max.13A
- ◆ 4 mechanical keying options - X/Y/Z/U, 2 color options: black or gray
- ◆ Accepts contact size #16, refer to page 26 for contact selections
- ◆ IP67, IP68, and IP6K9K, 48Kpa Air-tight (when mated)
- ◆ Flammability: UL94 V-0
- ◆ Accessories include back-shells, dust-caps, seal plugs, mounting clips. refer to page 28-31

USCM Series 10 Way Receptacles

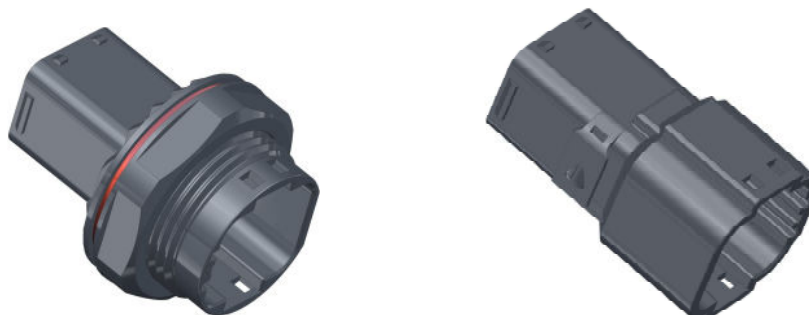

Keying	Color	Part Number	Description
X- Key	Black	USCM010-004	10 Way Jam-Nut Receptacle, X-Key, BK
	Gray	USCM010-006	10 Way Jam-Nut Receptacle, X-Key, GY
	Black	USCM010-104	10 Way Cable-to-Cable Receptacle, X-Key, BK
	Gray	USCM010-106	10 Way Cable-to-Cable Receptacle, X-Key, GY
Y- Key	Black	USCM010-008	10 Way Jam-Nut Receptacle, Y-Key, BK
	Gray	USCM010-010	10 Way Jam-Nut Receptacle, Y-Key, GY
	Black	USCM010-108	10 Way Cable-to-Cable Receptacle, Y-Key, BK
	Gray	USCM010-110	10 Way Cable-to-Cable Receptacle, Y-Key, GY
Z- Key	Black	USCM010-012	10 Way Jam-Nut Receptacle, Z-Key, BK
	Gray	USCM010-014	10 Way Jam-Nut Receptacle, Z-Key, GY
	Black	USCM010-112	10 Way Cable-to-Cable Receptacle, Z-Key, BK
	Gray	USCM010-114	10 Way Cable-to-Cable Receptacle, Z-Key, GY
U- Key	Black	USCM010-016	10 Way Jam-Nut Receptacle, U-Key, BK
	Gray	USCM010-018	10 Way Jam-Nut Receptacle, U-Key, GY
	Black	USCM010-116	10 Way Cable-to-Cable Receptacle, U-Key, BK
	Gray	USCM010-118	10 Way Cable-to-Cable Receptacle, U-Key, GY

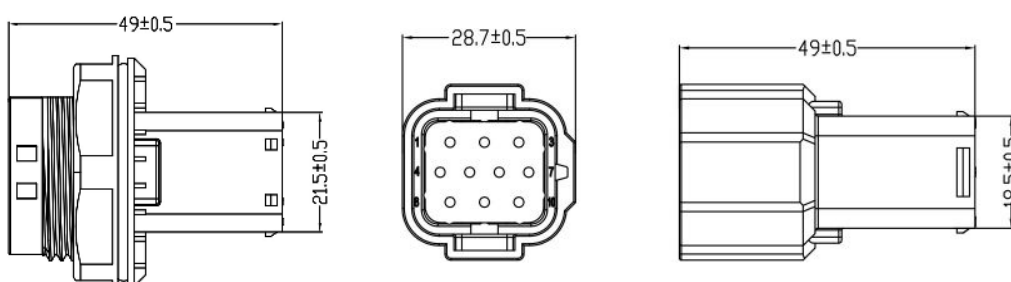

Key Features

- ◆ 10 Way Receptacles, signaling connectors, Current rating: Max.13
- ◆ Jam-Nut or Cable-to-Cable installation methods
- ◆ 4 mechanical keying options - X/Y/Z/U, 2 color options
- ◆ Accepts contact size #16, refer to page 26 for contact selections
- ◆ IP67, IP68, and IP6K9K, 48Kpa Air-tight (when mated)
- ◆ Flammability: UL94 V-0
- ◆ Accessories include back-shells, dust-caps, seal plugs, mounting clips. refer to page 28-31

USCM Series 12 Way Plugs



Keying	Color	Part Number	Description
X - Key	Black	USCM012-005	12 Way Plug, X-Key, Black
	Gray	USCM012-007	12 Way Plug, X-Key, Gray
Y - Key	Black	USCM012-009	12 Way Plug, Y-Key, Black
	Gray	USCM012-011	12 Way Plug, Y-Key, Gray
Z - Key	Black	USCM012-013	12 Way Plug, Z-Key, Black
	Gray	USCM012-015	12 Way Plug, Z-Key, Gray
U - Key	Black	USCM012-017	12 Way Plug, U-Key, Black
	Gray	USCM012-019	12 Way Plug, U-Key, Gray

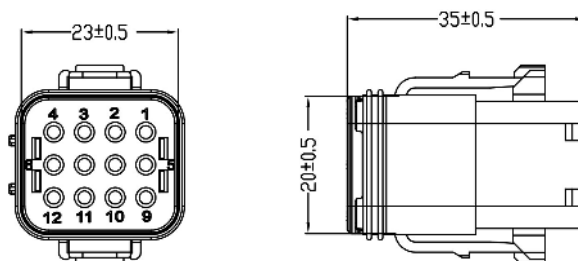

Key Features

- ◆ 12 Way Plugs, signaling connectors, Current rating: Max.13A
- ◆ 4 mechanical keying options - X/Y/Z/U, 2 color options: black or gray
- ◆ Accepts contact size #16, refer to page 26 for contact selections
- ◆ IP67, IP68, and IP6K9K, 48Kpa Air-tight (when mated)
- ◆ Flammability: UL94 V-0
- ◆ Accessories include back-shells, dust-caps, seal plugs, mounting clips. refer to page 28-31

USCM Series

12 Way Receptacles

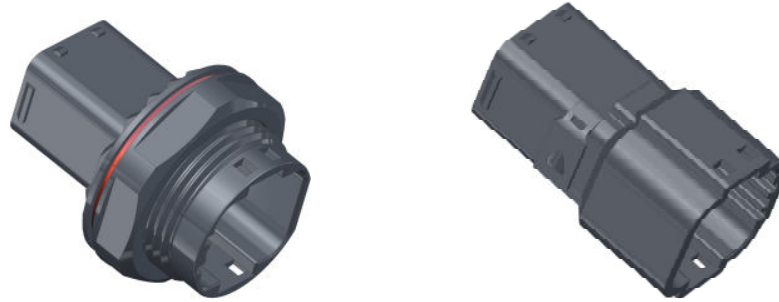

Keying	Color	Part Number	Description
X- Key	Black	USCM 012-004	12 Way Jam-Nut Receptacle, X-Key, BK
	Gray	USCM 012-006	12 Way Jam-Nut Receptacle, X-Key, GY
	Black	USCM 012-104	12 Way Cable-to-Cable Receptacle, X-Key, BK
	Gray	USCM 012-106	12 Way Cable-to-Cable Receptacle, X-Key, GY
Y- Key	Black	USCM 012-008	12 Way Jam-Nut Receptacle, Y-Key, BK
	Gray	USCM 012-010	12 Way Jam-Nut Receptacle, Y-Key, GY
	Black	USCM 012-108	12 Way Cable-to-Cable Receptacle, Y-Key, BK
	Gray	USCM 012-110	12 Way Cable-to-Cable Receptacle, Y-Key, GY
Z- Key	Black	USCM 012-012	12 Way Jam-Nut Receptacle, Z-Key, BK
	Gray	USCM 012-014	12 Way Jam-Nut Receptacle, Z-Key, GY
	Black	USCM 012-112	12 Way Cable-to-Cable Receptacle, Z-Key, BK
	Gray	USCM 012-114	12 Way Cable-to-Cable Receptacle, Z-Key, GY
U- Key	Black	USCM 012-016	12 Way Jam-Nut Receptacle, U-Key, BK
	Gray	USCM 012-018	12 Way Jam-Nut Receptacle, U-Key, GY
	Black	USCM 012-116	12 Way Cable-to-Cable Receptacle, U-Key, BK
	Gray	USCM 012-118	12 Way Cable-to-Cable Receptacle, U-Key, GY

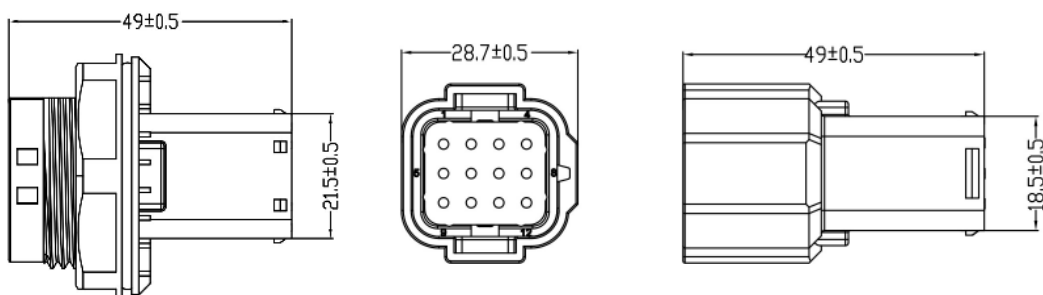

Key Features

- ◆ 12 Way Receptacles, signaling connectors, Current rating: Max.13
- ◆ Jam-Nut or Cable-to-Cable installation methods
- ◆ 4 mechanical keying options - X/Y/Z/U, 2 color options
- ◆ Accepts contact size #16, refer to page 26 for contact selections
- ◆ IP67, IP68, and IP6K9K, 48Kpa Air-tight (when mated)
- ◆ Flammability: UL94 V-0
- ◆ Accessories include back-shells, dust-caps, seal plugs, mounting clips. refer to page 28-31

Specifications and dimensions subject to change

USCM Series 16 Way Plugs



Keying	Color	Part Number	Description
X - Key	Black	USCM016-005	16 Way Plug, X-Key, Black
	Gray	USCM016-007	16 Way Plug, X-Key, Gray
Y - Key	Black	USCM016-009	16 Way Plug, Y-Key, Black
	Gray	USCM016-011	16 Way Plug, Y-Key, Gray
Z - Key	Black	USCM016-013	16 Way Plug, Z-Key, Black
	Gray	USCM016-015	16 Way Plug, Z-Key, Gray
U - Key	Black	USCM016-017	16 Way Plug, U-Key, Black
	Gray	USCM016-019	16 Way Plug, U-Key, Gray

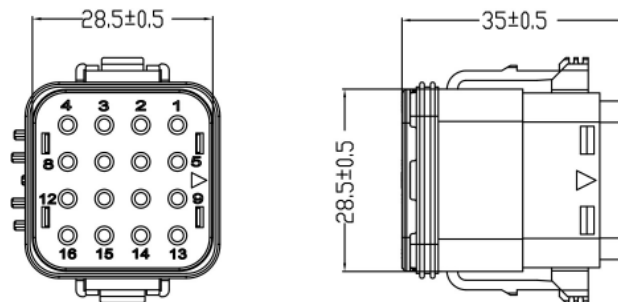

Key Features

- ◆ 16 Way Plugs, signaling connectors, Current rating: Max.13A
- ◆ 4 mechanical keying options - X/Y/Z/U, 2 color options: black or gray
- ◆ Accepts contact size #16, refer to page 26 for contact selections
- ◆ IP67, IP68, and IP6K9K, 48Kpa Air-tight (when mated)
- ◆ Flammability: UL94 V-0
- ◆ Accessories include back-shells, dust-caps, seal plugs, mounting clips. refer to page 28-31

USCM Series 16 Way Receptacles



Keying	Color	Part Number	Description
X- Key	Black	USCM016-004	16 Way Jam-Nut Receptacle, X-Key, BK
	Gray	USCM016-006	16 Way Jam-Nut Receptacle, X-Key, GY
	Black	USCM016-104	16 Way Cable-to-Cable Receptacle, X-Key, BK
	Gray	USCM016-106	16 Way Cable-to-Cable Receptacle, X-Key, GY
Y- Key	Black	USCM016-008	16 Way Jam-Nut Receptacle, Y-Key, BK
	Gray	USCM016-010	16 Way Jam-Nut Receptacle, Y-Key, GY
	Black	USCM016-108	16 Way Cable-to-Cable Receptacle, Y-Key, BK
	Gray	USCM016-110	16 Way Cable-to-Cable Receptacle, Y-Key, GY
Z- Key	Black	USCM016-012	16 Way Jam-Nut Receptacle, Z-Key, BK
	Gray	USCM016-014	16 Way Jam-Nut Receptacle, Z-Key, GY
	Black	USCM016-112	16 Way Cable-to-Cable Receptacle, Z-Key, BK
	Gray	USCM016-114	16 Way Cable-to-Cable Receptacle, Z-Key, GY
U- Key	Black	USCM016-016	16 Way Jam-Nut Receptacle, U-Key, BK
	Gray	USCM016-018	16 Way Jam-Nut Receptacle, U-Key, GY
	Black	USCM016-116	16 Way Cable-to-Cable Receptacle, U-Key, BK
	Gray	USCM016-118	16 Way Cable-to-Cable Receptacle, U-Key, GY

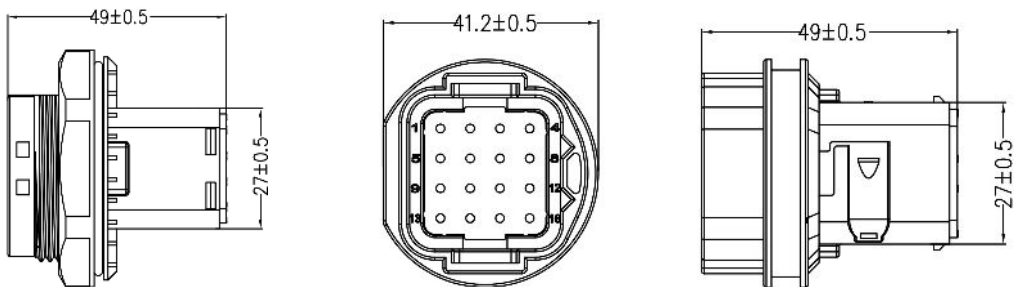

Key Features

- ◆ 16 Way Receptacles, signaling connectors, Current rating: Max.13
- ◆ Jam-Nut or Cable-to-Cable installation methods
- ◆ 4 mechanical keying options - X/Y/Z/U, 2 color options
- ◆ Accepts contact size #16, refer to page 26 for contact selections
- ◆ IP67, IP68, and IP6K9K, 48Kpa Air-tight (when mated)
- ◆ Flammability: UL94 V-0
- ◆ Accessories include back-shells, dust-caps, seal plugs, mounting clips. refer to page 28-31

Specifications and dimensions subject to change

USCM Series 12+4 Way Plugs



Keying	Color	Part Number	Description
X - Key	Black	USCM124-005	12+4 Way Plug, X-Key, Black
	Gray	USCM124-007	12+4 Way Plug, X-Key, Gray
Y - Key	Black	USCM124-009	12+4 Way Plug, Y-Key, Black
	Gray	USCM124-011	12+4 Way Plug, Y-Key, Gray
Z - Key	Black	USCM124-013	12+4 Way Plug, Z-Key, Black
	Gray	USCM124-015	12+4 Way Plug, Z-Key, Gray
U - Key	Black	USCM124-017	12+4 Way Plug, U-Key, Black
	Gray	USCM124-019	12+4 Way Plug, U-Key, Gray

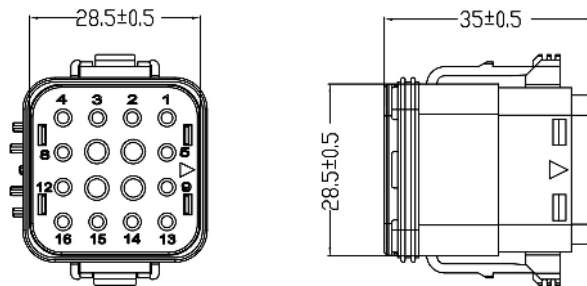

Key Features

- ◆ 12+4 Way Plugs, Mixed Layout: signaling + power connectors, Current rating: Max.13A&30A
- ◆ 4 mechanical keying options - X/Y/Z/U, 2 color options: black or gray
- ◆ Accepts contact size #16 & size #12, refer to page 26 for contact selections
- ◆ IP67, IP68, and IP6K9K, 48Kpa Air-tight (when mated)
- ◆ Flammability: UL94 V-0
- ◆ Accessories include back-shells, dust-caps, seal plugs, mounting clips. refer to page 28-31

USCM Series 12+4 Way Receptacles



Keying	Color	Part Number	Description
X- Key	Black	USCM124-004	12+4 Way Jam-Nut Receptacle, X-Key, BK
	Gray	USCM124-006	12+4 Way Jam-Nut Receptacle, X-Key, GY
	Black	USCM124-104	12+4 Way Cable-to-Cable Receptacle, X-Key, BK
	Gray	USCM124-106	12+4 Way Cable-to-Cable Receptacle, X-Key, GY
Y- Key	Black	USCM124-008	12+4 Way Jam-Nut Receptacle, Y-Key, BK
	Gray	USCM124-010	12+4 Way Jam-Nut Receptacle, Y-Key, GY
	Black	USCM124-108	12+4 Way Cable-to-Cable Receptacle, Y-Key, BK
	Gray	USCM124-110	12+4 Way Cable-to-Cable Receptacle, Y-Key, GY
Z- Key	Black	USCM124-012	12+4 Way Jam-Nut Receptacle, Z-Key, BK
	Gray	USCM124-014	12+4 Way Jam-Nut Receptacle, Z-Key, GY
	Black	USCM124-112	12+4 Way Cable-to-Cable Receptacle, Z-Key, BK
	Gray	USCM124-114	12+4 Way Cable-to-Cable Receptacle, Z-Key, GY
U- Key	Black	USCM124-016	12+4 Way Jam-Nut Receptacle, U-Key, BK
	Gray	USCM124-018	12+4 Way Jam-Nut Receptacle, U-Key, GY
	Black	USCM124-116	12+4 Way Cable-to-Cable Receptacle, U-Key, BK
	Gray	USCM124-118	12+4 Way Cable-to-Cable Receptacle, U-Key, GY

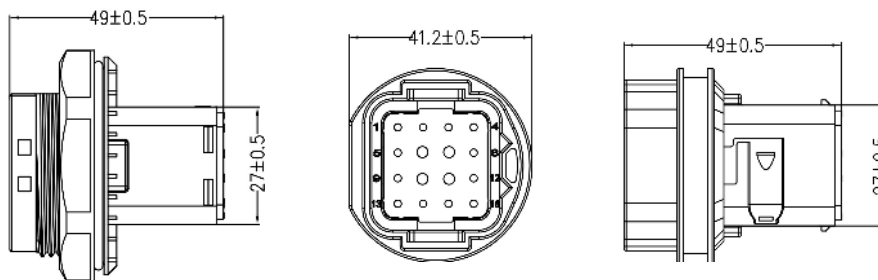

Key Features

- ◆ 12+4 Way Plugs, Mixed Layout: signaling + power connectors, Current rating: Max. 13A&30A
- ◆ Jam-Nut or Cable-to-Cable installation methods
- ◆ 4 mechanical keying options - X/Y/Z/U, 2 color options
- ◆ Accepts contact size #16 & size #12, refer to page 26 for contact selections
- ◆ IP67, IP68, and IP6K9K, 48Kpa Air-tight (when mated)
- ◆ Flammability: UL94 V-0
- ◆ Accessories include back-shells, dust-caps, seal plugs, mounting clips. refer to page 28-31

Specifications and dimensions subject to change

USCM Series 25 Way Plugs



Keying	Color	Part Number	Description
X - Key	Black	USCM025-005	25 Way Plug, X-Key, Black
	Gray	USCM025-007	25 Way Plug, X-Key, Gray
Y - Key	Black	USCM025-009	25 Way Plug, Y-Key, Black
	Gray	USCM025-011	25 Way Plug, Y-Key, Gray
Z - Key	Black	USCM025-013	25 Way Plug, Z-Key, Black
	Gray	USCM025-015	25 Way Plug, Z-Key, Gray
U - Key	Black	USCM025-017	25 Way Plug, U-Key, Black
	Gray	USCM025-019	25 Way Plug, U-Key, Gray

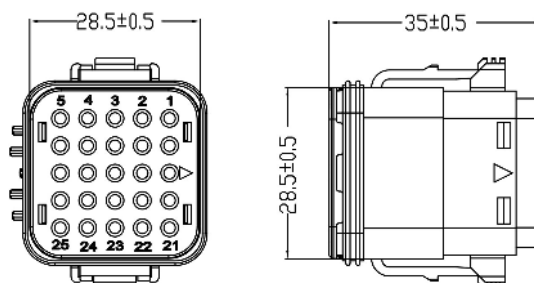

Key Features

- ◆ 25 Way Plugs, signaling connectors, Current rating: Max.13A
- ◆ 4 mechanical keying options - X/Y/Z/U, 2 color options: black or gray
- ◆ Accepts contact size #16, refer to page 26 for contact selections
- ◆ IP67, IP68, and IP6K9K, 48Kpa Air-tight (when mated)
- ◆ Flammability: UL94 V-0
- ◆ Accessories include back-shells, dust-caps, seal plugs, mounting clips. refer to page 28-31

USCM Series 25 Way Receptacles



Keying	Color	Part Number	Description
X- Key	Black	USCM025-004	25 Way Jam-Nut Receptacle, X-Key, BK
	Gray	USCM025-006	25 Way Jam-Nut Receptacle, X-Key, GY
	Black	USCM025-104	25 Way Cable-to-Cable Receptacle, X-Key, BK
	Gray	USCM025-106	25 Way Cable-to-Cable Receptacle, X-Key, GY
Y- Key	Black	USCM025-008	25 Way Jam-Nut Receptacle, Y-Key, BK
	Gray	USCM025-010	25 Way Jam-Nut Receptacle, Y-Key, GY
	Black	USCM025-108	25 Way Cable-to-Cable Receptacle, Y-Key, BK
	Gray	USCM025-110	25 Way Cable-to-Cable Receptacle, Y-Key, GY
Z- Key	Black	USCM025-012	25 Way Jam-Nut Receptacle, Z-Key, BK
	Gray	USCM025-014	25 Way Jam-Nut Receptacle, Z-Key, GY
	Black	USCM025-112	25 Way Cable-to-Cable Receptacle, Z-Key, BK
	Gray	USCM025-114	25 Way Cable-to-Cable Receptacle, Z-Key, GY
U- Key	Black	USCM025-016	25 Way Jam-Nut Receptacle, U-Key, BK
	Gray	USCM025-018	25 Way Jam-Nut Receptacle, U-Key, GY
	Black	USCM025-116	25 Way Cable-to-Cable Receptacle, U-Key, BK
	Gray	USCM025-118	25 Way Cable-to-Cable Receptacle, U-Key, GY

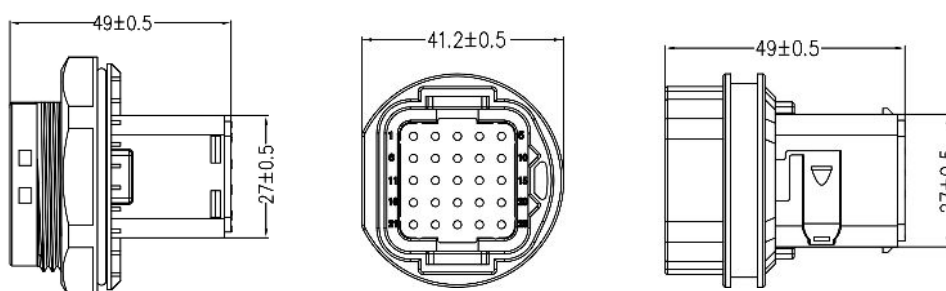

Key Features

- ◆ 16 Way Receptacles, signaling connectors, Current rating: Max.13
- ◆ Jam-Nut or Cable-to-Cable installation methods
- ◆ 4 mechanical keying options - X/Y/Z/U, 2 color options
- ◆ Accepts contact size #16, refer to page 26 for contact selections
- ◆ IP67, IP68, and IP6K9K, 48Kpa Air-tight (when mated)
- ◆ Flammability: UL94 V-0
- ◆ Accessories include back-shells, dust-caps, seal plugs, mounting clips. refer to page 28-31

Specifications and dimensions subject to change

Stamped Contact System

Contact Resistance

Cable Range AWG (mm ²)	Current(A)	Voltage Drop (mV Max.)
12 (4.0)	30	100
14 (2.5)	25	100
16 (1.5)	13	100
18 (1.0)	10	100
20 (0.5)	7.5	100

Contact Features

- Size #16 signal contacts, current rate: Max 13A
 - Size #12 power contacts, current rate: Max 30A
 - Contact clip with 3prongs, used with individual seals
 - Nickel and gold flash plating options
 - Contact durability \cong 200 times
 - Cable ranges:
- Signal contacts: 22AWG (0.35mm²) to 14AWG(2.5mm²)
 Power contacts: 16AWG (1.5mm²) to 12AWG(4.0mm²)

Stamped & Plated Contacts

Size 16#, Cable-Range		Type	Nickel Plated (2000/reel)	Gold Plated (2000/reel)	Cable Φ OD
mm ²	AWG				
0.35 - 0.50	22 - 20 AWG	Pin	USCT000-055	USCT000-255	Φ 1.20-1.60mm
0.35 - 0.50	22 - 20 AWG	Socket	USCT000-054	USCT000-254	Φ 1.20-1.60mm
0.75 - 1.50	18 - 16 AWG	Pin	USCT000-051	USCT000-251	Φ 1.40-2.40mm
0.75 - 1.50	18 - 16 AWG	Socket	USCT000-050	USCT000-250	Φ 1.40-2.40mm
1.50 - 2.50	16 - 14 AWG	Pin	USCT000-053	USCT000-253	< Φ 2.40mm (ultrathin cable) or customized connectors
1.50 - 2.50	16 - 14 AWG	Socket	USCT000-052	USCT000-252	
Size 12#, Cable-Range		Type	Tin Plated (3000/reel)	Gold Plated (3000/reel)	Cable Φ OD
mm ²	AWG				
1.5 - 2.50	16 - 14 AWG	Pin	USCT000-087	USCT000-287	Φ 2.20-3.00mm
1.5 - 2.50	16 - 14 AWG	Socket	USCT000-088	USCT000-288	Φ 2.20-3.00mm
4.00	12 AWG	Pin	USCT000-095	USCT000-295	Φ 3.40-3.70mm
4.00	12 AWG	Socket	USCT000-096	USCT000-296	Φ 3.40-3.70mm



Size #12



Size #16

Contacts Crimp Tool

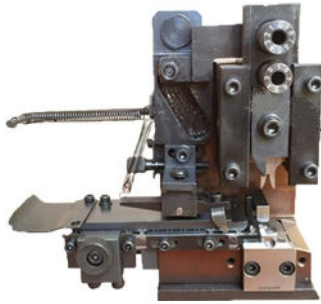

Cable Size/AWG (mm ²)	Tool No.	Description
#12 (4.0)	T-0307	Automatic crimp tool
#14 (2.5)	T-0306	Automatic crimp tool
#16 (1.5)	T-0305	Automatic crimp tool
#18 (1.0)	T-0304	Automatic crimp tool
#20 (0.5)	T-0303	Automatic crimp tool



Cable Size/AWG (mm ²)	Tool No.	Description
#12 (4.0)	T-1307	Hand crimp tool
#14 (2.5)	T-1306	Hand crimp tool
#16 (1.5)	T-1305	Hand crimp tool
#18 (1.0)	T-1304	Hand crimp tool
#20 (0.5)	T-1303	Hand crimp tool

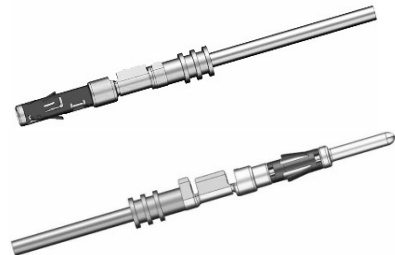
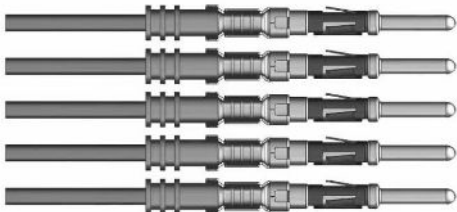

Contact Removal Tool



Contact Type	Tool No.	Description
Signal Pin (Φ1.6mm)	T-00301	Tool for STD contacts
Power Pin(Φ2.5mm)	T-00206	Tool for Power contacts

Cable Seal & Blind Plugs

The design of the USCM series adopts individual sealing plugs to achieve excellent environmental sealing, Wire Seals are required for connectors without an integrated rear seal to maintain an environmental seal.

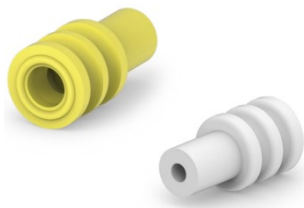

Size 16# contacts accept below cable seals:

Acceptable cables (OD)	P/Ns	Color	Type
Φ1.2mm-Φ1.6mm	USCM49711	Red	Cable Seal
Φ1.4mm-Φ1.9mm	USCM35301	Gray	Cable Seal
Φ1.9mm-Φ2.4mm	USCM49721	Yellow	Cable Seal
N/A	USCM35311	White	Blind plug



Size 12# contacts accept below cable seals:

Acceptable cables (OD)	P/Ns	Color	Type
Φ1.2mm-Φ2.1mm	USCM89041	Light-Blue	Cable Seal
Φ2.2mm-Φ3.0mm	USCM89051	White	Cable Seal
Φ3.1mm-Φ3.7mm	USCM89061	Blue	Cable Seal
N/A	USCM89221	White	Blind plug

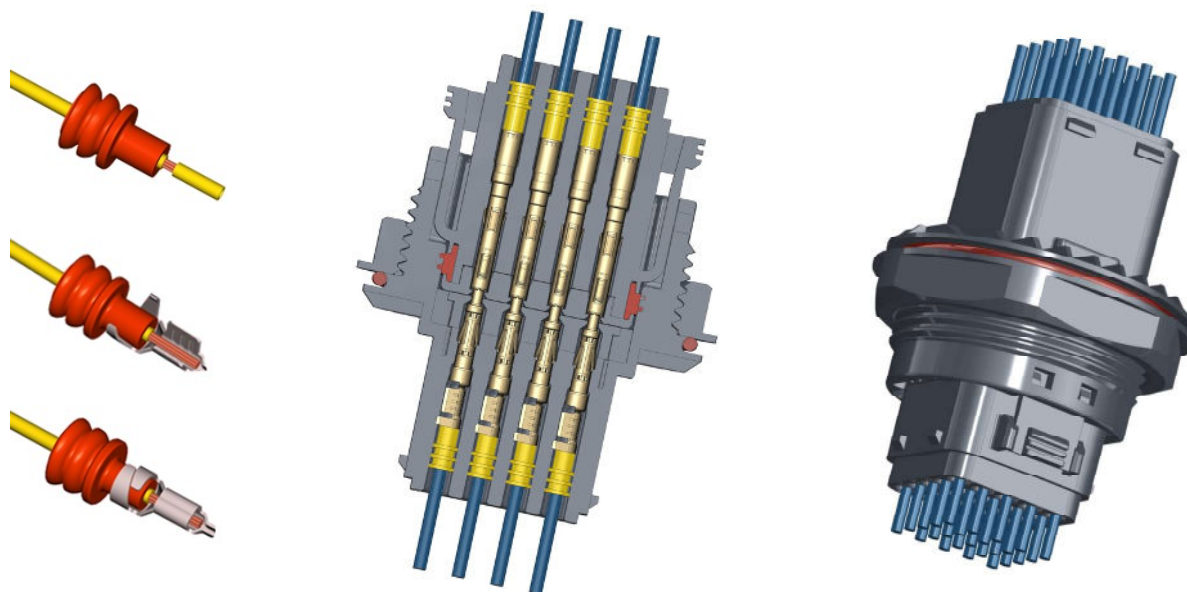

USCM Series Accessories of the connectors

We offer a variety of accessories include back-shells, dust-caps, seal plugs, mounting clips...These specialized accessories cover a wide range of connector usage requirements, providing additional protection of the overall harness solution, and offering enhanced aesthetics

Mounting Clips of the receptacles

An integrated V-groove on all receptacles accepts various cable mounting accessories;



Straight Mounting Clip
stainless steel
P/N: [USCM00M-002](#)

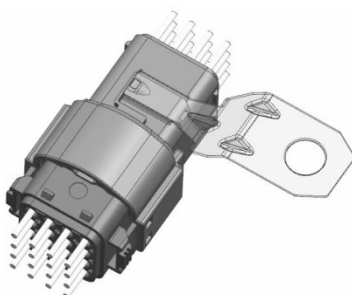

Angled Mounting Clip
stainless steel
P/N: [USCM00M-003](#)

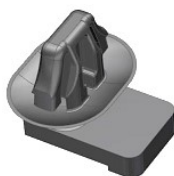

Fixing Clip
Plastic
P/N: [USCM00M-001](#)

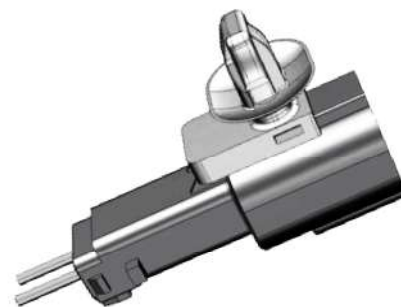

Cable-to-Cable receptacle
mounted plastic clip



Cable Ties



12+4/16/25 Way
Cable-to-Cable receptacles
mounted Cable Tie

Back-Shells

The USCM series back-shells can be directly assembled onto the rear of the connectors to secure cables & conduit to provide additional protection against environmental conditions as well as provide additional strain relief to the cables;



End-Bell Type	P/N	Color	Conduit Pipes
2-Way Straight End-Bell	USCM0AS-111	BK	OD13/ID9
2-Way Straight End-Bell	USCM0AS-113	GY	OD13/ID9
4-Way Straight End-Bell	USCM0BS-111	BK	OD13/ID9
4-Way Straight End-Bell	USCM0BS-113	GY	OD13/ID9
4-Way Straight End-Bell	USCM0BS-115	BK	OD10/ID6.5
4-Way Straight End-Bell	USCM0BS-117	GY	OD10/ID6.5
6/8/10/12-Way Straight End-Bell	USCM0CS-111	BK	OD17/ID12
6/8/10/12-Way Straight End-Bell	USCM0CS-113	GY	OD17/ID12
6/8/10/12-Way Straight End-Bell	USCM0CS-115	BK	OD13/ID9
6/8/10/12-Way Straight End-Bell	USCM0CS-117	GY	OD13/ID9
6/8/10/12-Way Angled End-Bell	USCM0CA-112	BK	OD17/ID12
6/8/10/12-Way Angled End-Bell	USCM0CA-114	GY	OD17/ID12
6/8/10/12-Way Angled End-Bell	USCM0CA-116	BK	OD13/ID9
6/8/10/12-Way Angled End-Bell	USCM0CA-118	GY	OD13/ID9
12+4/16/25-Way Straight End-Bell	USCM0DS-111	BK	OD25.7/ID19.9
12+4/16/25-Way Straight End-Bell	USCM0DS-113	GY	OD25.7/ID19.9
12+4/16/25-Way Straight End-Bell	USCM0DS-115	BK	OD21.0/ID17.0
12+4/16/25-Way Straight End-Bell	USCM0DS-117	GY	OD21.0/ID17.0
12+4/16/25-Way Angled End-Bell	USCM0DA-112	BK	OD25.7/ID19.9
12+4/16/25-Way Angled End-Bell	USCM0DA-114	GY	OD25.7/ID19.9
12+4/16/25-Way Angled End-Bell	USCM0DA-116	BK	OD21.0/ID17.0
12+4/16/25-Way Angled End-Bell	USCM0DA-118	GY	OD21.0/ID17.0

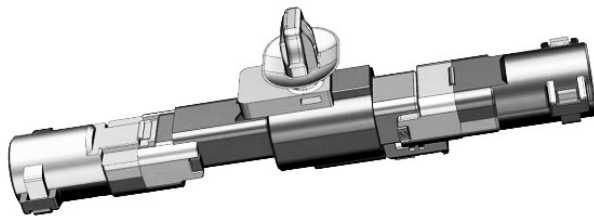

Dust-Cap

USCM dust-cap provide an environmental sealing and are used to protect the connector interface when the plug and receptacle are not mated.



Dust-Cap for the receptacles (dustproof + waterproof, IPX5)

Compatible Connectors	P/N	Color	Type
4Way receptacles	USCMDC-004	BK	Rubber Cover
6/8/10/12Way receptacles	USCMDC-006	BK	Rubber Cover
16/12+4/25Way receptacles	USCMDC-016	BK	Rubber Cover
4Way receptacles	USCMDC-004L	BK	Rubber Cover + Tie
6/8/10/12Way receptacles	USCMDC-006L	BK	Rubber Cover + Tie
16/12+4/25Way receptacles	USCMDC-016L	BK	Rubber Cover + Tie



Dust-Cap for the receptacles (dustproof + waterproof, IPX67)

Compatible Connectors	P/N	Color	Type
4Way receptacles	USCMDC-004P	BK	Plastic Cover
6/8/10/12Way receptacles	USCMDC-006P	BK	Plastic Cover
16/12+4/25Way receptacles	USCMDC-016P	BK	Plastic Cover
4Way receptacles	USCMDC-004PL	BK	Plastic Cover +Tie
6/8/10/12Way receptacles	USCMDC-006PL	BK	Plastic Cover +Tie
16/12+4/25Way receptacles	USCMDC-016PL	BK	Plastic Cover +Tie

Operating Instructions

Contact insertion and removal

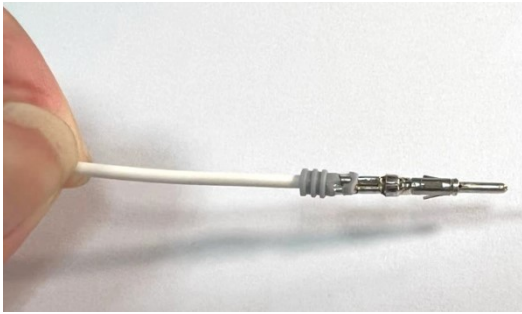

Insertion: Step-1#:

Grasp crimped contact approximately 1.5~2.0cm behind the contact

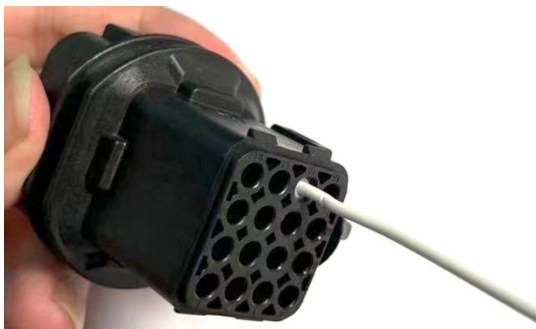

Insertion: Step-3#:

Push contact straight into connector until a click is felt. A slight tug will confirm that it is properly locked in place.

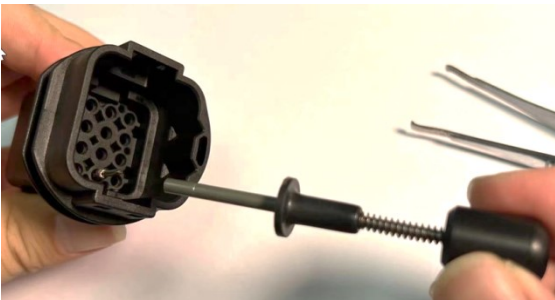

Removal: Step-2#

Insert the tool into the contact cavity from the mating direction, push the tube fully into the cavity



Insertion: Step-2#:

Make sure the contact is in the correct orientation. Insert the contacts vertically into the connector holes

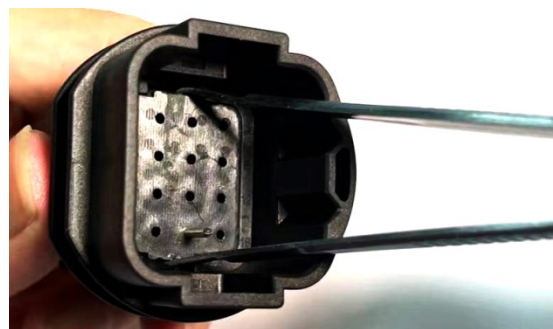

Removal: Step-1#

Using a specialized tool (Tweezers or pliers with barbs) remove out the locating cover



Removal: Step-3#

Depress the plunger to eject the contact, the contact can be removed from the back of the connector

Amphenol

Amphenol is one of the world's largest designers, manufacturers and marketers of connectors and interconnect systems, antennas solutions, sensors and high-speed cable. Our connector and connector system solutions include fiber optic interconnect, harsh environment interconnect, high-speed interconnect, power interconnect, power distribution and busbars and radio frequency (RF) interconnect products. Our sensors and sensor-based product solutions include gas and moisture sensors, level sensors, position sensor, pressure sensors, temperature sensors and vibration sensors. Our value-added cable assemblies include cable assemblies and harnesses, cable management products and backplane interconnect systems. Our cable solutions include coaxial cable, power cable and specialty cable. We also provide combiner/splitter products, flexible and rigid printed circuit boards, hinges and molded parts.

Contact us

Connect with your Amphenol representative or visit us at: www.amphenol-gec.com

Changzhou, China
Tel:+86 519-8981 9713

Guangzhou, China
Tel: +86 20-3210 6099

Winnipeg Canada
Tel: +1 204-697 2222

Nogales, Mexico
Tel: +52(55) 5258-9984

单击下面可查看定价，库存，交付和生命周期等信息

[>>Amphenol\(安费诺\)](#)