

GENERAL DESCRIPTION

The SGM2079 is a low noise, high PSRR, low dropout voltage linear regulator. It is capable of supplying 1A output current with typical dropout voltage of only 130mV. The operating input voltage range is from 2.2V to 5.5V. The SGM2079 is available in fixed output voltage versions and an adjustable version that allows the output voltage range from 0.8V to 5V.

Other features include logic-controlled shutdown mode, short-circuit current limit and thermal shutdown protection. The SGM2079 has automatic discharge function to quickly discharge V_{OUT} in the disabled status.

The SGM2079 is available in a Green TDFN-3×3-8JL package. It operates over an operating temperature range of -40°C to +125°C.

FEATURES

- **Operating Input Voltage Range: 2.2V to 5.5V**
- **Enable Pin Accept Voltages Higher than the Supply Voltage and up to 5.5V**
- **Fixed Output from 0.8V to 5V**
- **Adjustable Output from 0.8V to 5V**
- **1A Output Current**
- **Output Voltage Accuracy: ±2% at +25°C**
- **Low Dropout Voltage: 130mV (TYP) at 1A**
- **Low Noise at $V_{OUT(NOM)} = 1.2V$ (10Hz to 100kHz):**
 - ♦ 22µV_{RMS} (TYP)
- **Power Supply Rejection Ratio at $V_{OUT(NOM)} = 1.1V$:**
 - ♦ 74dB (TYP) at 1kHz
 - ♦ 66dB (TYP) at 10kHz
 - ♦ 42dB (TYP) at 1MHz
- **Current Limiting and Thermal Protection**
- **Excellent Load and Line Transient Responses**
- **With Output Automatic Discharge**
- **Stable with Small Case Size Ceramic Capacitors**
- **-40°C to +125°C Operating Temperature Range**
- **Available in a Green TDFN-3×3-8JL Package**

APPLICATIONS

PLL/VCO/RF Circuit
Audio Equipment

TYPICAL APPLICATION

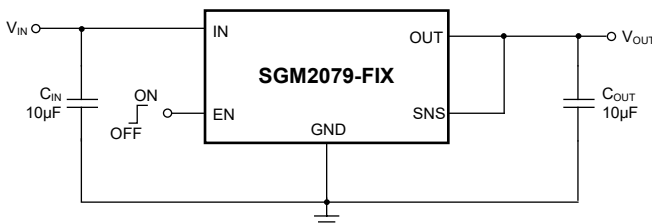

Fixed Voltage Typical Application Circuit

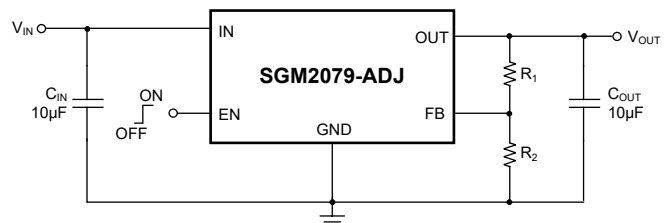

Adjustable Voltage Typical Application Circuit

Figure 1. Typical Application Circuits

PACKAGE/ORDERING INFORMATION

MODEL	PACKAGE DESCRIPTION	SPECIFIED TEMPERATURE RANGE	ORDERING NUMBER	PACKAGE MARKING	PACKING OPTION
SGM2079-1.2	TDFN-3×3-8JL	-40°C to +125°C	SGM2079-1.2XTHI8G/TR	SGM 0Y4THI XXXXXX	Tape and Reel, 4000
SGM2079-1.8	TDFN-3×3-8JL	-40°C to +125°C	SGM2079-1.8XTHI8G/TR	SGM 0Y5THI XXXXXX	Tape and Reel, 4000
SGM2079-2.8	TDFN-3×3-8JL	-40°C to +125°C	SGM2079-2.8XTHI8G/TR	SGM 1F6THI XXXXXX	Tape and Reel, 4000
SGM2079-3.0	TDFN-3×3-8JL	-40°C to +125°C	SGM2079-3.0XTHI8G/TR	SGM 1F7THI XXXXXX	Tape and Reel, 4000
SGM2079-3.3	TDFN-3×3-8JL	-40°C to +125°C	SGM2079-3.3XTHI8G/TR	SGM 0Y6THI XXXXXX	Tape and Reel, 4000
SGM2079-5.0	TDFN-3×3-8JL	-40°C to +125°C	SGM2079-5.0XTHI8G/TR	SGM 1F8THI XXXXXX	Tape and Reel, 4000
SGM2079-ADJ	TDFN-3×3-8JL	-40°C to +125°C	SGM2079-ADJXTHI8G/TR	SGM 0Y7THI XXXXXX	Tape and Reel, 4000

MARKING INFORMATION

NOTE: XXXXX = Date Code, Trace Code and Vendor Code.

XXXXX

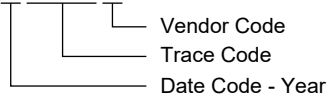

Green (RoHS & HSF): SG Micro Corp defines "Green" to mean Pb-Free (RoHS compatible) and free of halogen substances. If you have additional comments or questions, please contact your SGMICRO representative directly.

ABSOLUTE MAXIMUM RATINGS

IN to GND	-0.3V to 6V
OUT to GND	-0.3V to (V _{IN} + 0.3V)
FB, SNS to GND	-0.3V to 6V
EN to GND	-0.3V to 6V
Package Thermal Resistance	
TDFN-3×3-8JL, θ _{JA}	51.3°C/W
TDFN-3×3-8JL, θ _{JB}	23.4°C/W
TDFN-3×3-8JL, θ _{JC(TOP)}	50.2°C/W
TDFN-3×3-8JL, θ _{JC(BOT)}	12.2°C/W
Junction Temperature	+150°C
Storage Temperature Range	-65°C to +150°C
Lead Temperature (Soldering, 10s)	+260°C
ESD Susceptibility	
HBM	8000V
CDM	1000V

RECOMMENDED OPERATING CONDITIONS

Operating Input Voltage Range, V _{IN}	2.2V to 5.5V
Enable Voltage Range	0V to 5.5V
Input Effective Capacitance, C _{IN}	2.2µF (MIN)
Output Effective Capacitance, C _{OUT}	2.2µF to 220µF
Operating Junction Temperature Range	-40°C to +125°C

OVERSTRESS CAUTION

Stresses beyond those listed in Absolute Maximum Ratings may cause permanent damage to the device. Exposure to absolute maximum rating conditions for extended periods may affect reliability. Functional operation of the device at any conditions beyond those indicated in the Recommended Operating Conditions section is not implied.

ESD SENSITIVITY CAUTION

This integrated circuit can be damaged if ESD protections are not considered carefully. SGMICRO recommends that all integrated circuits be handled with appropriate precautions. Failure to observe proper handling and installation procedures can cause damage. ESD damage can range from subtle performance degradation to complete device failure. Precision integrated circuits may be more susceptible to damage because even small parametric changes could cause the device not to meet the published specifications.

DISCLAIMER

SG Micro Corp reserves the right to make any change in circuit design, or specifications without prior notice.

PIN CONFIGURATIONS

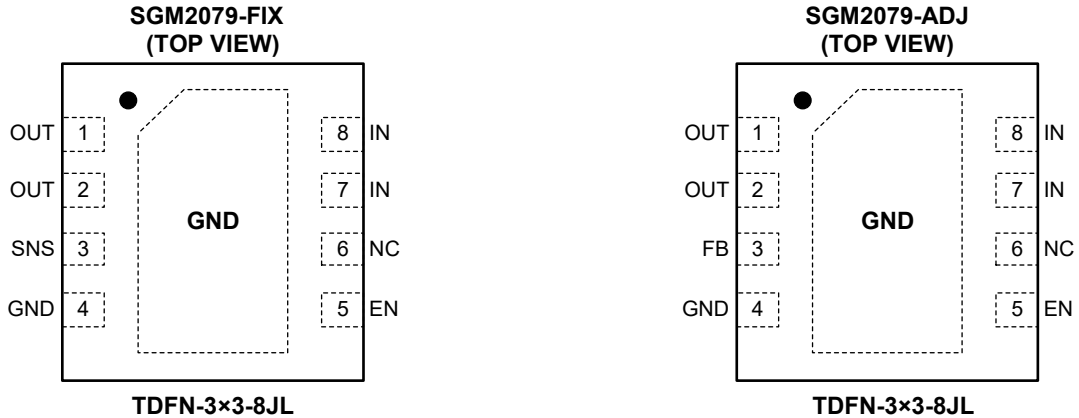

PIN DESCRIPTION

PIN	NAME	FUNCTION
1, 2	OUT	Regulator Output Pin. It is recommended to use a ceramic capacitor with effective capacitance in the range of 2.2µF to 220µF to ensure stability. This ceramic capacitor should be placed as close as possible to OUT pin.
3	FB	Feedback Voltage Input Pin (adjustable voltage version only). Connect this pin to the midpoint of an external resistor divider to adjust the output voltage. Place the resistors as close as possible to this pin.
	SNS	Output Voltage Sense Input Pin (fixed voltage version only). Connect this pin to the load side of the output trace only in the fixed voltage version.
4	GND	Ground.
5	EN	Enable Pin. Drive EN high to turn on the regulator. Drive EN low to turn off the regulator. The EN pin has an internal pull-down current source.
6	NC	No Connection.
7, 8	IN	Input Supply Voltage Pin. It is recommended to use a 4.7µF or larger ceramic capacitor from IN pin to ground to get good power supply decoupling. This ceramic capacitor should be placed as close as possible to IN pin.
Exposed Pad	GND	Exposed Pad. Connect it to a large ground plane to maximize thermal performance. This pad is not an electrical connection point.

FUNCTIONAL BLOCK DIAGRAM

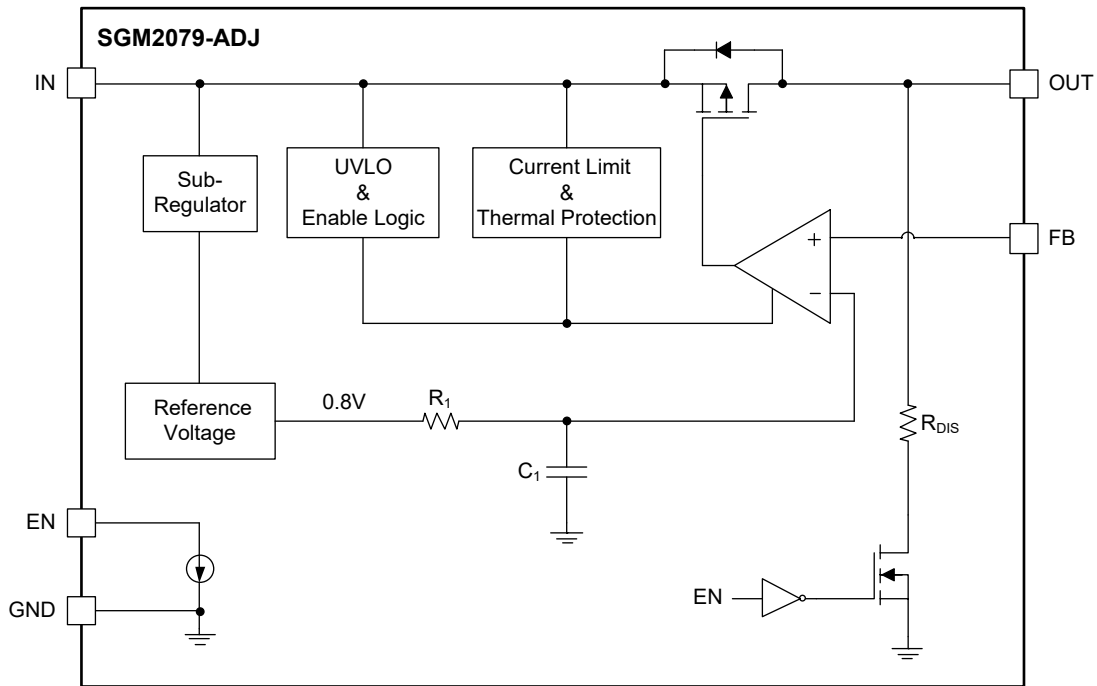

Figure 2. Adjustable Output Voltage Internal Block Diagram

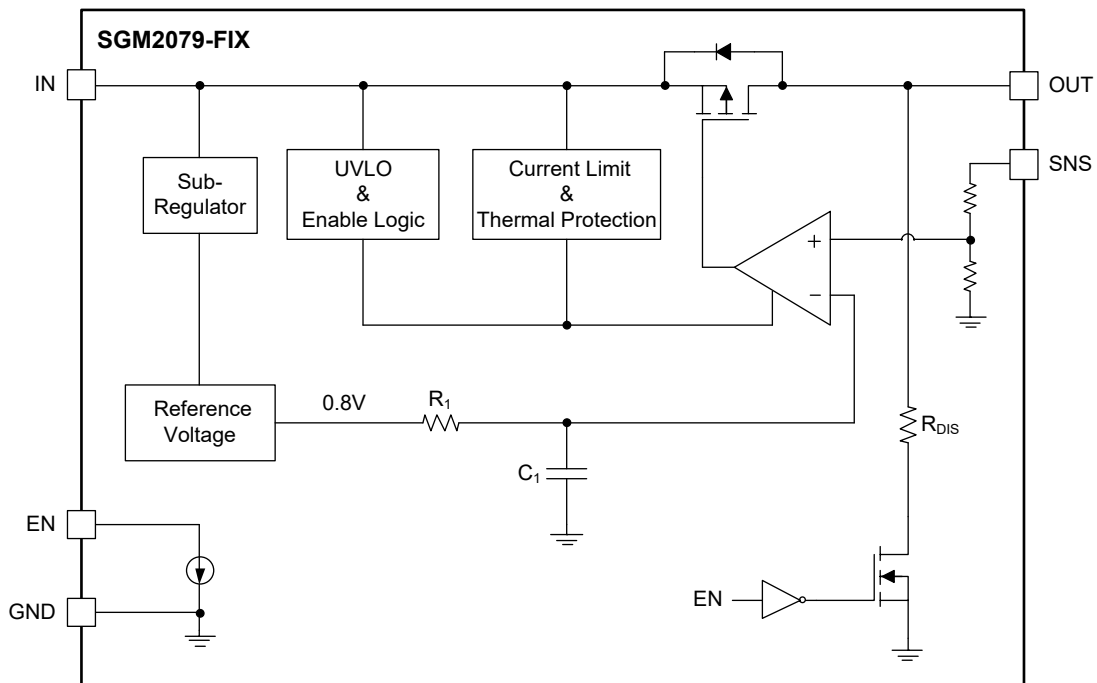

Figure 3. Fixed Output Voltage Internal Block Diagram

ELECTRICAL CHARACTERISTICS

($V_{IN} = (V_{OUT(NOM)} + 0.5V)$ or 2.2V (whichever is greater), $V_{EN} = 2.2V$, $I_{OUT} = 1mA$, $C_{IN} = 4.7\mu F$, $C_{OUT} = 4.7\mu F$. For SGM2079-ADJ, tested at $V_{OUT} = 0.8V$, $T_J = -40^\circ C$ to $+125^\circ C$, typical values are at $T_J = +25^\circ C$, unless otherwise noted.)

PARAMETER	SYMBOL	CONDITIONS	MIN	TYP	MAX	UNITS	
Output Voltage Range	V_{OUT}		0.8		5	V	
Output Voltage Accuracy	V_{OUT}	$V_{IN} = (V_{OUT(NOM)} + 0.5V)$ to 5.5V, $V_{IN} \geq 2.2V$, $I_{OUT} = 1mA$ to 1A	$T_J = +25^\circ C$	-2	2	%	
			$T_J = -40^\circ C$ to $+125^\circ C$	-2.5	2.5		
Reference Voltage	V_{ADJ}	SGM2079-ADJ	$T_J = +25^\circ C$	0.784	0.8	0.816	V
			$T_J = -40^\circ C$ to $+125^\circ C$	0.780		0.820	
Feedback Pin Current	I_{ADJ}	$V_{IN} = 5.5V$, $V_{ADJ} = 0.9V$	-100		100	nA	
Under-Voltage Lockout Thresholds	V_{UVLO}	V_{IN} rising	1.65	1.8	1.9	V	
		Hysteresis		200		mV	
Line Regulation	$\Delta V_{OUT}/V_{OUT}$	$V_{IN} = (V_{OUT(NOM)} + 0.5V)$ to 5.5V, $V_{IN} \geq 2.2V$		0.04	0.13	%	
Load Regulation	$\Delta V_{OUT}/V_{OUT}$	$I_{OUT} = 1mA$ to 1A		0.18	0.65	%	
Dropout Voltage	V_{DROP}	$V_{ADJ} = GND$ or $V_{SNS} = GND$, $V_{IN} = 2.5V$, $I_{OUT} = 1A$		130	260	mV	
Output Current Limit	I_{LIMIT}	$V_{OUT} = 90\% \times V_{OUT(NOM)}$, $V_{IN} = V_{OUT(NOM)} + 1V$	1.2	1.75	2.4	A	
Short Current Limit	I_{SHORT}	$V_{OUT} = 0V$		1.58		A	
Ground Pin Current	I_{GND}	No load, $V_{IN} = 5.5V$	SGM2079-ADJ	90	200	μA	
			SGM2079-FIX	100	200		
		$I_{OUT} = 1A$		680	900		
Shutdown Current	I_{SHDN}	$V_{EN} \leq 0.4V$		0.03	3	μA	
EN Pin High-Level Input Voltage	$V_{EN(H)}$	$2.2V \leq V_{IN} \leq 5.5V$	1.2		5.5	V	
EN Pin Low-Level Input Voltage	$V_{EN(L)}$		0		0.4	V	
EN Pin Current	I_{EN}	$V_{IN} = 5.5V$, $V_{EN} = 0V$		0.01	1	μA	
		$V_{IN} = 5.5V$, $V_{EN} = 5.5V$		0.11	1		
Turn-On Time	t_{ON}	From assertion of V_{EN} to $V_{OUT} = 90\% \times V_{OUT(NOM)}$		150	280	μs	
Rising Time	t_R	$V_{OUT} = 10\%$ to $90\% \times V_{OUT(NOM)}$		80	180	μs	
Power Supply Rejection Ratio	PSRR	$V_{IN} = 2.5V$, $V_{OUT(NOM)} = 1.1V$, $I_{OUT} = 1A$	$f = 1kHz$		74	dB	
			$f = 10kHz$		66		
			$f = 1MHz$		42		
Output Voltage Noise	e_n	$I_{OUT} = 100mA$, $f = 10Hz$ to $100kHz$	$V_{OUT(NOM)} = 1.2V$		22	μV_{RMS}	
			$V_{OUT(NOM)} = 3.3V$		58		
Output Discharge Resistance	R_{DIS}	$V_{IN} = 2.2V$		100	200	Ω	
Thermal Shutdown Temperature	T_{SHDN}			165		$^\circ C$	
Thermal Shutdown Hysteresis	ΔT_{SHDN}			30		$^\circ C$	

TYPICAL PERFORMANCE CHARACTERISTICS

$T_J = +25^\circ\text{C}$, $V_{OUT} = 1.1\text{V}$, $V_{EN} = V_{IN} = 2.2\text{V}$, $C_{IN} = 2.2\mu\text{F}$, $C_{OUT} = 4.7\mu\text{F}$, unless otherwise noted.

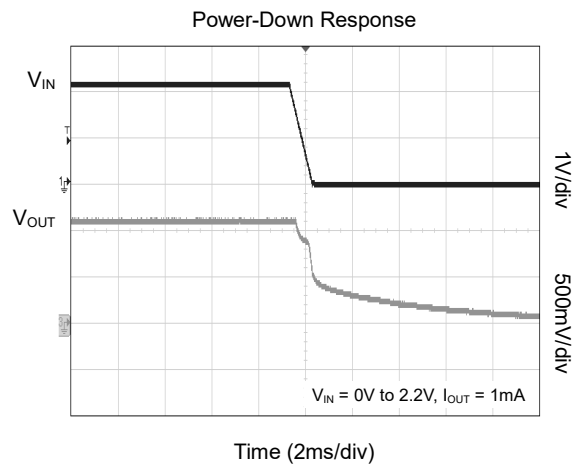
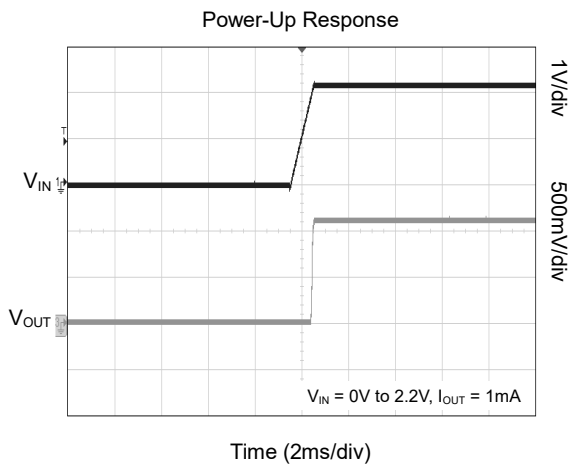
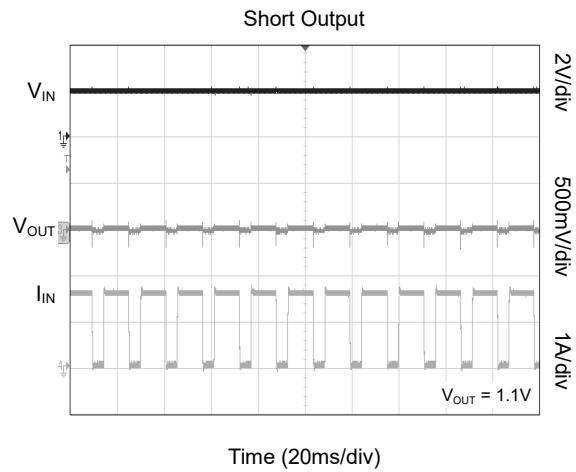
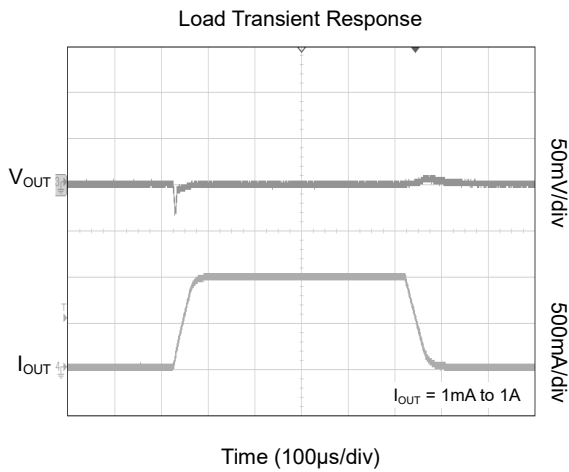
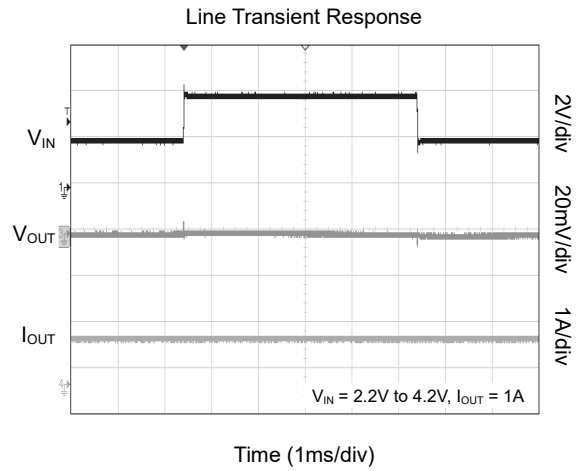
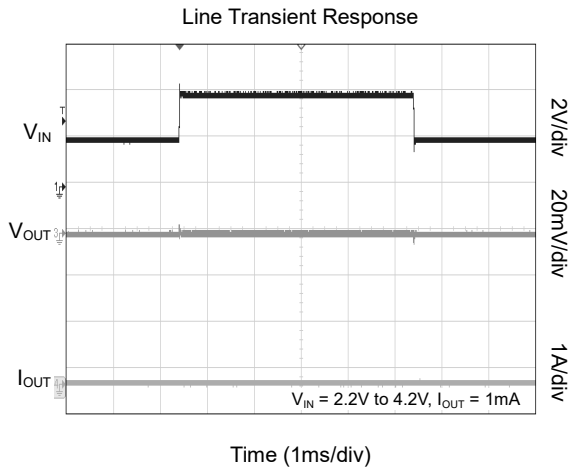

TYPICAL PERFORMANCE CHARACTERISTICS (continued)

$T_J = +25^\circ\text{C}$, $V_{OUT} = 1.1\text{V}$, $V_{EN} = V_{IN} = 2.2\text{V}$, $C_{IN} = 2.2\mu\text{F}$, $C_{OUT} = 4.7\mu\text{F}$, unless otherwise noted.

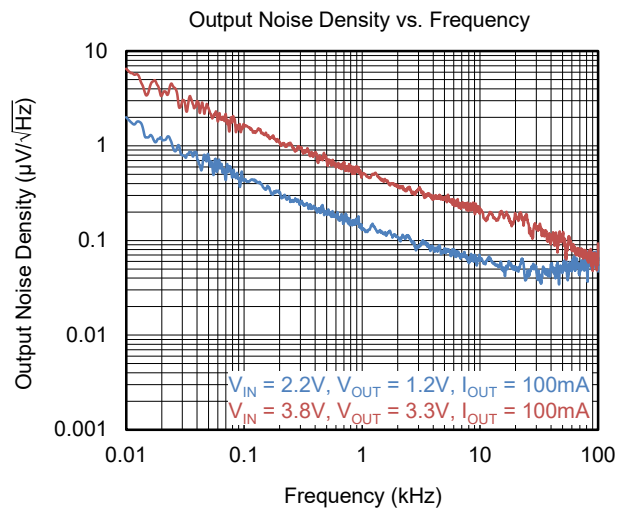
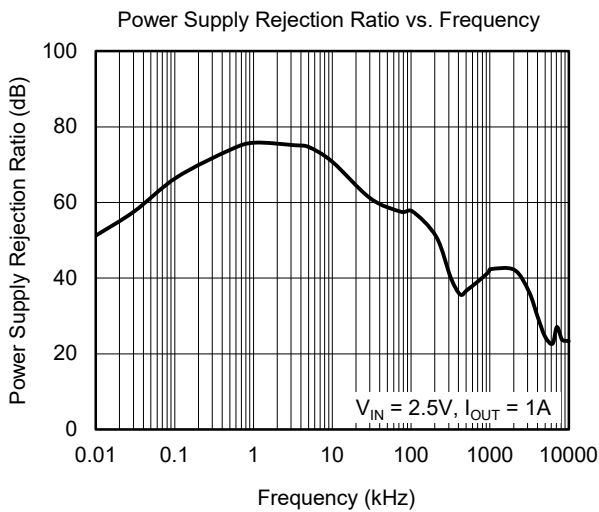
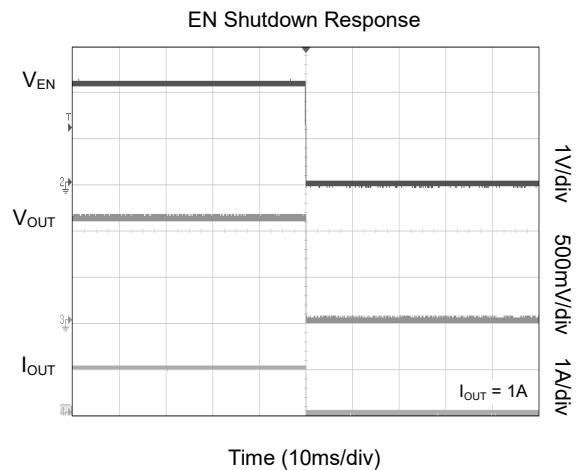
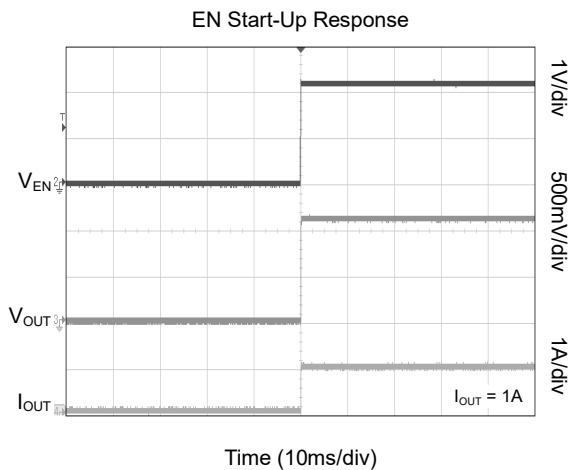
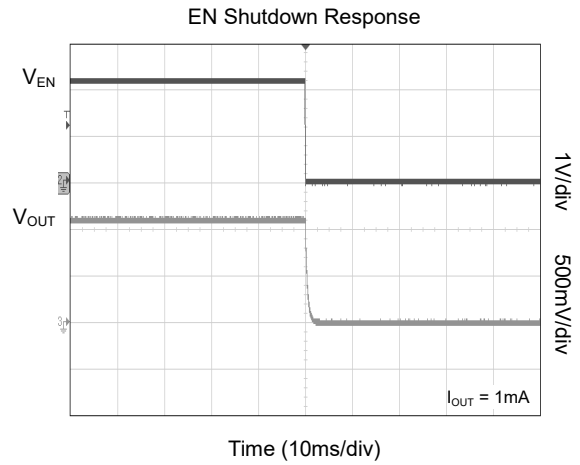
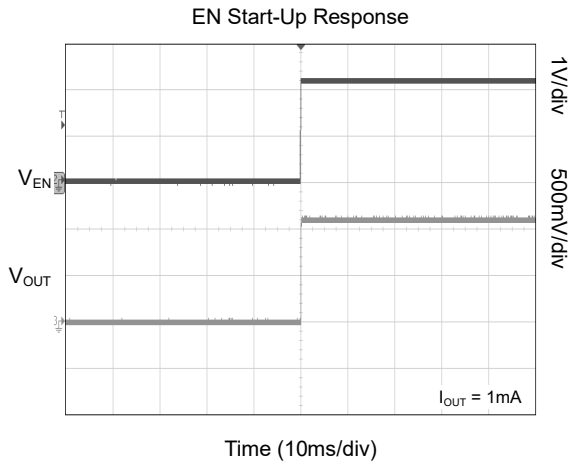

SGM2079 1A, Low Noise, Wide Bandwidth, High PSRR, Low Dropout Linear Regulator

TYPICAL PERFORMANCE CHARACTERISTICS (continued)

$T_J = +25^\circ\text{C}$, $V_{OUT} = 1.1\text{V}$, $V_{EN} = V_{IN} = 2.2\text{V}$, $C_{IN} = 2.2\mu\text{F}$, $C_{OUT} = 4.7\mu\text{F}$, unless otherwise noted.

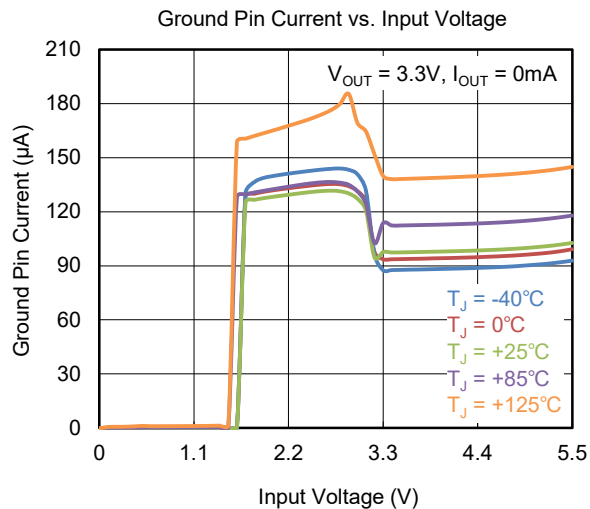
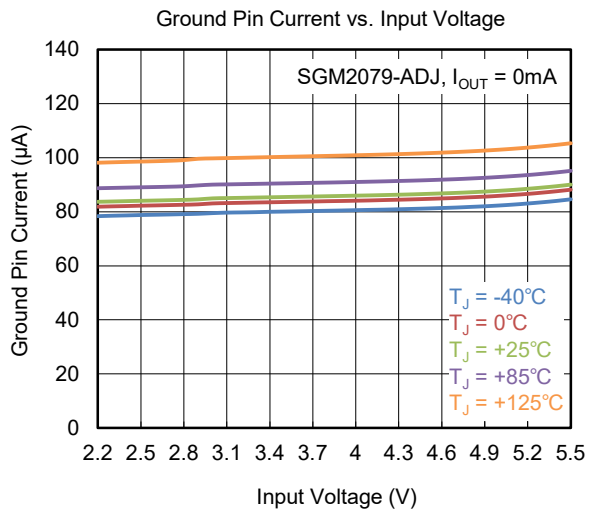
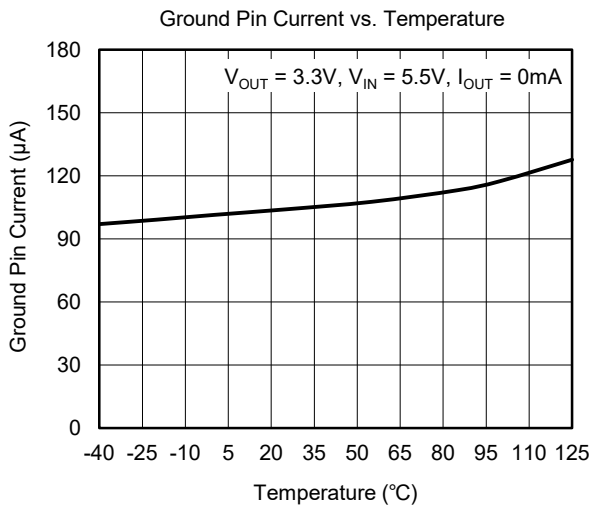
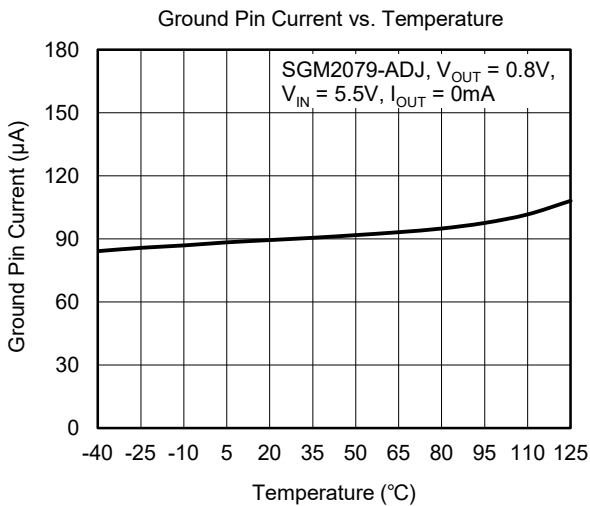
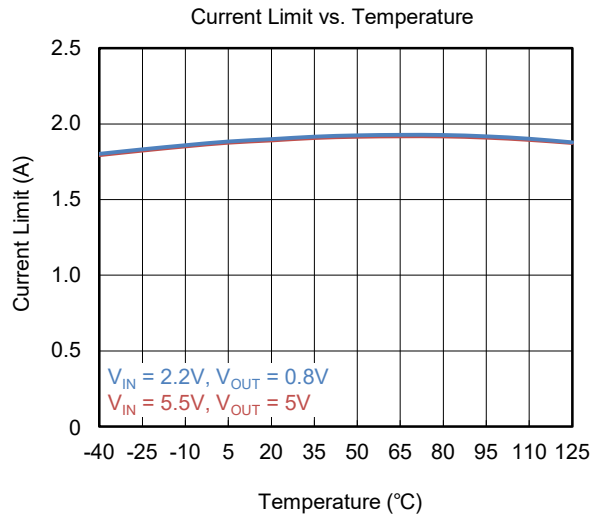
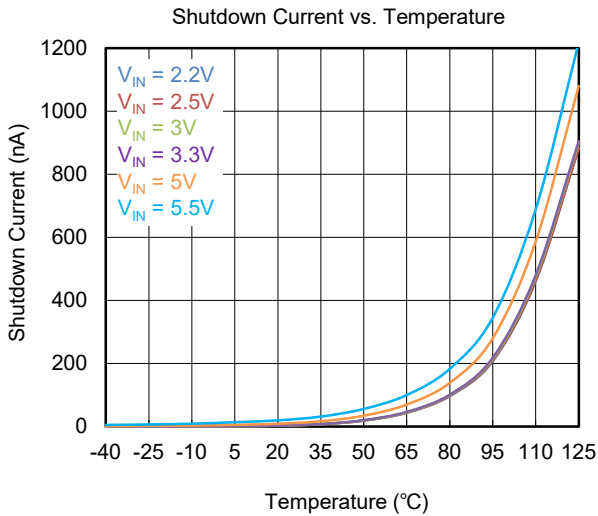

SGM2079 1A, Low Noise, Wide Bandwidth, High PSRR, Low Dropout Linear Regulator

TYPICAL PERFORMANCE CHARACTERISTICS (continued)

$T_J = +25^\circ\text{C}$, $V_{OUT} = 1.1\text{V}$, $V_{EN} = V_{IN} = 2.2\text{V}$, $C_{IN} = 2.2\mu\text{F}$, $C_{OUT} = 4.7\mu\text{F}$, unless otherwise noted.

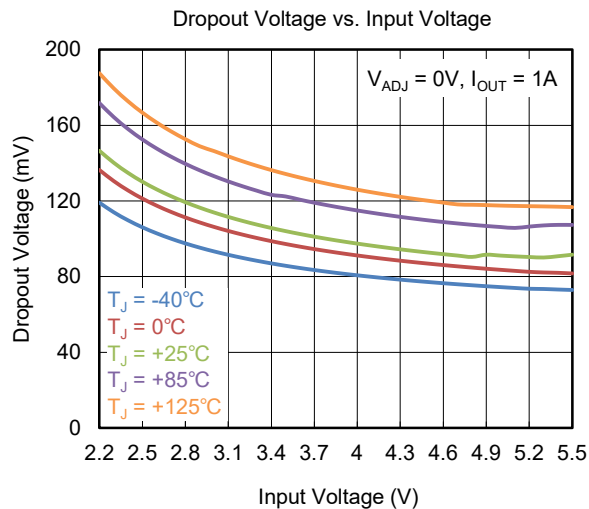
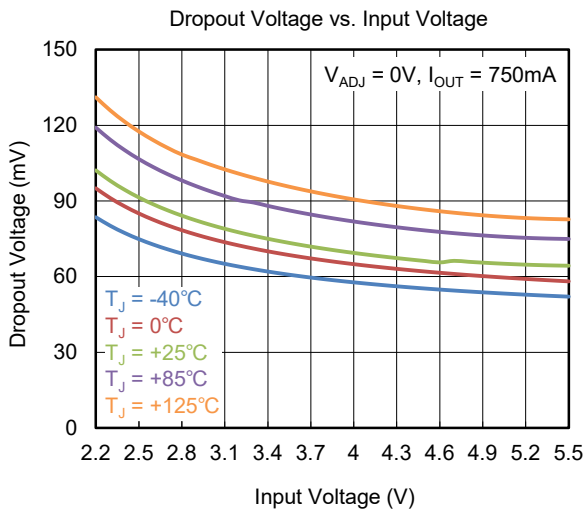
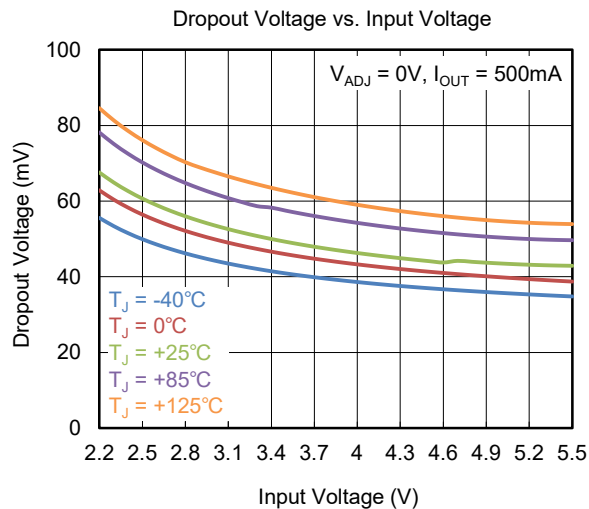
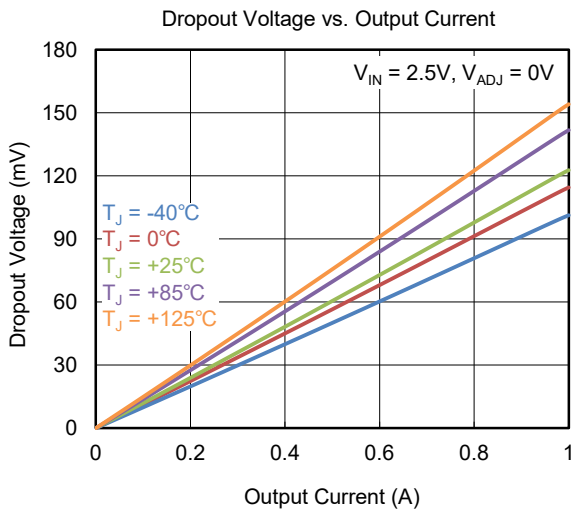
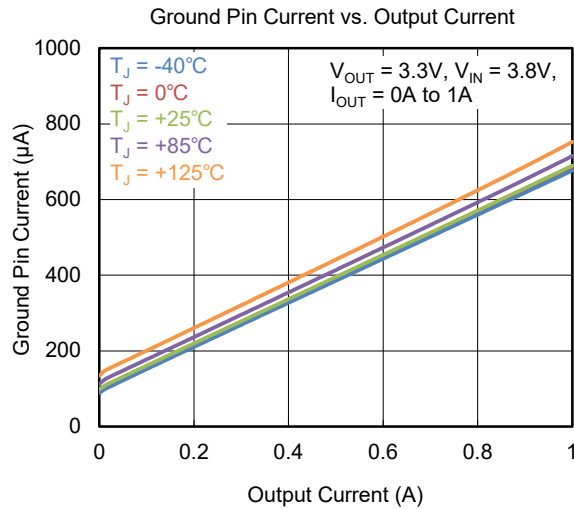
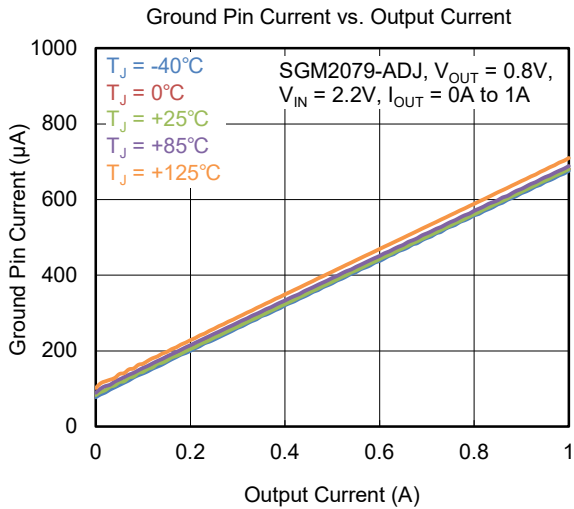

TYPICAL PERFORMANCE CHARACTERISTICS (continued)

$T_J = +25^\circ\text{C}$, $V_{OUT} = 1.1\text{V}$, $V_{EN} = V_{IN} = 2.2\text{V}$, $C_{IN} = 2.2\mu\text{F}$, $C_{OUT} = 4.7\mu\text{F}$, unless otherwise noted.

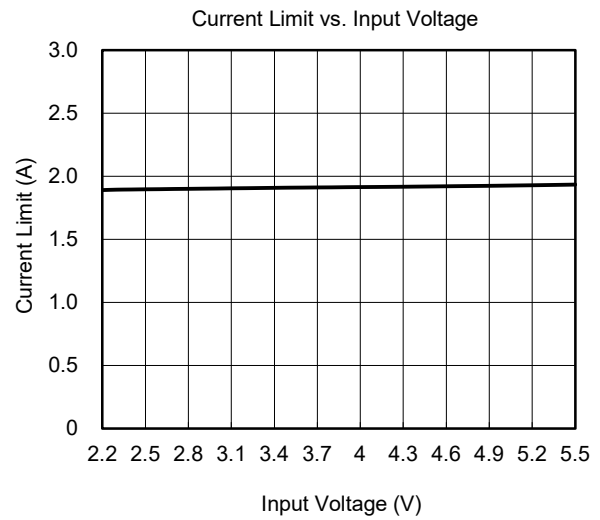
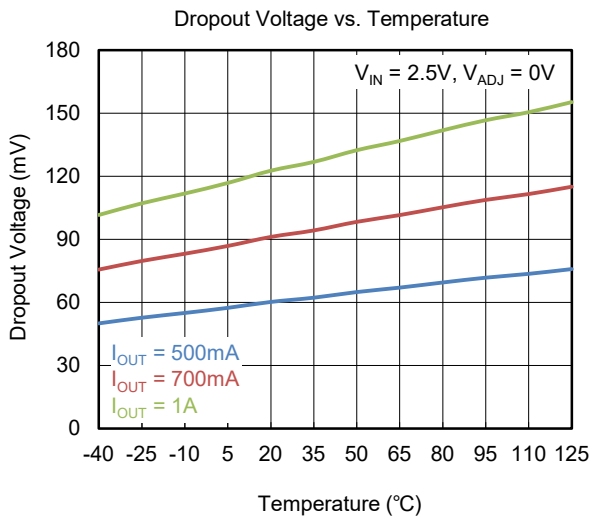

APPLICATION INFORMATION

The SGM2079 is a low noise, high PSRR and fast transient response LDO and provides 1A output current. These features make the device a reliable solution to solve many challenging problems in the generation of clean and accurate power supply. The high performance also makes the SGM2079 useful in a variety of applications. The SGM2079 provides the protection function for output overload, output short-circuit condition and overheating.

The SGM2079 provides an EN pin as an external chip enable control to enable/disable the device. When the regulator is in shutdown state, the shutdown current consumes as low as 0.03μA (TYP).

Input Capacitor Selection (C_{IN})

The input decoupling capacitor should be placed as close as possible to the IN pin to ensure the device stability. 4.7μF or larger X7R or X5R ceramic capacitor is selected to get good dynamic performance.

When V_{IN} is required to provide large current instantaneously, a large effective input capacitor is required. Multiple input capacitors can limit the input tracking inductance. Adding more input capacitors is available to restrict the ringing and keep it below the device absolute maximum ratings. For C_{OUT} with larger capacitance, it is recommended to choose the larger capacitance C_{IN} .

Output Capacitor Selection (C_{OUT})

The output capacitor should be placed as close as possible to the OUT pin. 4.7μF or larger X7R or X5R ceramic capacitor is selected to get good dynamic performance. The minimum effective capacitance of C_{OUT} that SGM2079 can remain stable is 2.2μF. For ceramic capacitor, temperature, DC bias and package size will change the effective capacitance, thus, enough margin of C_{OUT} must be considered in design. Additionally, C_{OUT} with larger capacitance and lower ESR will help increase the high frequency PSRR and improve the load transient response.

Dropout Voltage and V_{IN}

The SGM2079 features low dropout voltage due to low $R_{DS(ON)}$ PMOSFET power transistor. For Linear

regulator, when $(V_{IN} - V_{OUT}) < \text{dropout voltage } (V_{DROP})$, the PMOSFET power transistor will be turned on like a switch, the parameter of linear regulator, such as PSRR, load and input transient responses, will be degraded so much. To get good performance in application, the V_{IN} must be larger than $(V_{OUT} + V_{DROP})$.

Adjustable Regulator

The output voltage of the SGM2079-ADJ can be adjusted from 0.8V to 5V. The FB pin will be connected to two external resistors as shown in Figure 4. The output voltage is determined by the following equation:

$$V_{OUT} = V_{ADJ} \times \left(1 + \frac{R_1}{R_2} \right) \quad (1)$$

where:

V_{OUT} is output voltage and V_{ADJ} is the internal voltage reference, $V_{ADJ} = 0.8V$. R_1 and R_2 can be calculated for any output voltage range using equation 1. To ensure stability, R_2 must not exceed 80kΩ with a minimum load of 10μA.

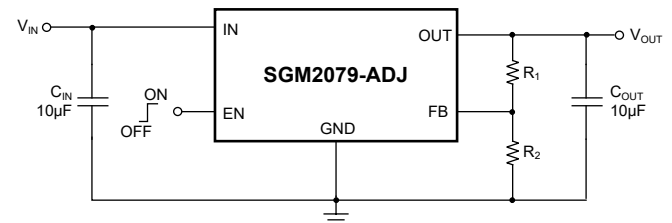

Figure 4. Adjustable Output Voltage Application

Enable Operation

The SGM2079 uses the EN pin to enable/disable the device and to deactivate/activate the output automatic discharge function.

When the EN pin voltage is lower than 0.4V, the device is in shutdown state. There is no current flowing from IN to OUT pins. In this state, the automatic discharge transistor is active to discharge the output voltage through a 100Ω (TYP) resistor.

When the EN pin voltage is higher than 1.2V, the device is in active state. The output voltage is regulated to the expected value and the automatic discharge transistor is turned off.

APPLICATION INFORMATION (continued)

Under-Voltage Lockout (UVLO)

The UVLO circuit monitors the input voltage to prevent the device from turning on before V_{IN} rises above the V_{UVLO} threshold. The UVLO circuit responds quickly to glitches on the IN pin and attempts to disable the output of the device if any of these rails collapses. The local input capacitance prevents severe brownouts in most applications.

Reverse Current Protection

The power transistor has an inherent body diode. This body diode will be forward biased when $V_{OUT} > (V_{IN} + 0.3V)$. When $V_{OUT} > (V_{IN} + 0.3V)$, the reverse current flowing from the OUT pin to the IN pin will damage the SGM2079. If $V_{OUT} > (V_{IN} + 0.3V)$ event would happen in system, one external Schottky diode will be added between OUT pin and IN pin in circuit design to protect the SGM2079.

Negatively Biased Output

When the output voltage is negative, the chip may not start up due to parasitic effects. Ensure that the output is greater than $-0.3V$ under all conditions. If negatively biased output is excessive and expected in the application, a Schottky diode can be added between the OUT pin and GND pin.

Output Current Limit and Short-Circuit Protection

When overload events happen, the output current is internally limited to 1.75A (TYP). When the OUT pin is shorted to ground, the short-circuit protection will limit the output current to 1.58A (TYP).

Thermal Shutdown

When the die temperature exceeds the threshold value of thermal shutdown, the SGM2079 will be in shutdown state and remain in this state until the die temperature decreases to $+135^{\circ}C$.

Power Dissipation (P_D)

Power dissipation (P_D) of the SGM2079 can be calculated by the equation $P_D = (V_{IN} - V_{OUT}) \times I_{OUT}$. The maximum allowable power dissipation ($P_{D(MAX)}$) of the SGM2079 is affected by many factors, including the difference between junction temperature and ambient temperature ($T_{J(MAX)} - T_A$), package thermal resistance from the junction to the ambient environment (θ_{JA}), the rate of ambient airflow and PCB layout. $P_{D(MAX)}$ can be approximated by the following equation:

$$P_{D(MAX)} = (T_{J(MAX)} - T_A) / \theta_{JA} \tag{2}$$

Layout Guidelines

To get good PSRR, low output noise and high transient response performance, the input and output bypass capacitors must be placed as close as possible to the IN pin and OUT pin separately.

REVISION HISTORY

NOTE: Page numbers for previous revisions may differ from page numbers in the current version.

Changes from Original (JUNE 2024) to REV.A	Page
Changed from product preview to production data.....	All

PACKAGE OUTLINE DIMENSIONS

TDFN-3x3-8JL

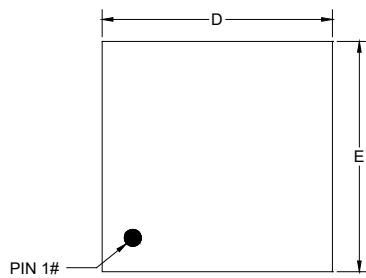

TOP VIEW

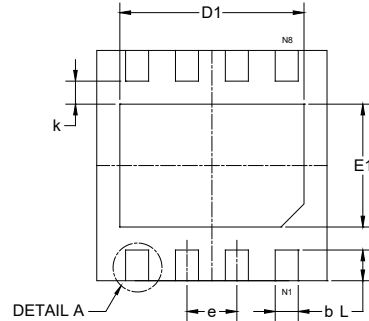

BOTTOM VIEW

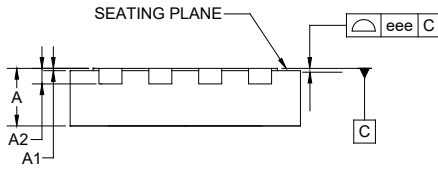

SIDE VIEW

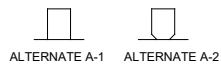

DETAIL A
ALTERNATE TERMINAL
CONSTRUCTION

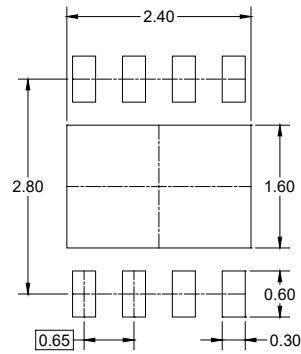

RECOMMENDED LAND PATTERN (Unit: mm)

Symbol	Dimensions in Millimeters		
	MIN	MOD	MAX
A	0.700	-	0.800
A1	0.000	-	0.050
A2	0.203 REF		
b	0.250	-	0.350
D	2.900	-	3.100
D1	2.300	-	2.500
E	2.900	-	3.100
E1	1.500	-	1.700
e	0.650 BSC		
k	0.300 REF		
L	0.300	-	0.500
eee	0.080		

NOTE: This drawing is subject to change without notice.

PACKAGE INFORMATION

TAPE AND REEL INFORMATION

REEL DIMENSIONS



TAPE DIMENSIONS



NOTE: The picture is only for reference. Please make the object as the standard.

KEY PARAMETER LIST OF TAPE AND REEL

Package Type	Reel Diameter	Reel Width W1 (mm)	A0 (mm)	B0 (mm)	K0 (mm)	P0 (mm)	P1 (mm)	P2 (mm)	W (mm)	Pin1 Quadrant
TDFN-3×3-8JL	13"	12.4	3.35	3.35	1.13	4.0	8.0	2.0	12.0	Q1

000001

PACKAGE INFORMATION

CARTON BOX DIMENSIONS



NOTE: The picture is only for reference. Please make the object as the standard.

KEY PARAMETER LIST OF CARTON BOX

Reel Type	Length (mm)	Width (mm)	Height (mm)	Pizza/Carton
13"	386	280	370	5

DD0002

单击下面可查看定价，库存，交付和生命周期等信息

[>>SGMICRO\(圣邦微电子\)](#)