

Product Summary

V_{DS}	1700 V
$I_D (T_c=25^\circ\text{C})$	7 A
$R_{DS(on),typ}$	600 m Ω @ $V_{GS}=18\text{V}$

Features

- Low On-Resistance with High Blocking Voltage
- Low Capacitance
- Avalanche Ruggedness
- Halogen Free, Rohs Compliant

Benefits

- High Frequency Operation
- Enabling Higher Switching Frequency
- Increased Power Density
- Reduction of Heat Sink Requirements

Applications

- Switch Mode Power Supplies (SMPS)
- Power Inverter & Solar Inverter
- Motor Drivers & EV Charging Station
- DC/DC Converter

Package Pin Definitions

- Pin1 - Gate
- Pin2 - Drain
- Pin3 - Source

Package Parameters

Part Number	Marking	Package
B2M600170H	B2M600170H	TO-247-3

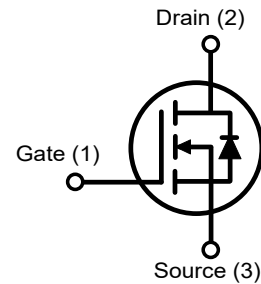
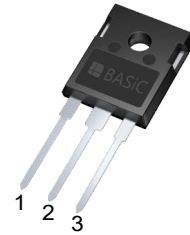
Package: TO-247-3

Maximum Ratings

Symbol	Parameter	Test conditions	Value	Unit
V_{DSmax}	Drain-Source Voltage	$V_{GS}=0V, I_D=100\mu A$	1700	V
$V_{GSmax}^{1)}$	Gate-Source Voltage		-10/22	V
V_{GSop}	Recommend Gate-Source Voltage		-4/18	V
I_D	Continuous Drain Current	$V_{GS}=18V, T_C=25^\circ C$	7	A
		$V_{GS}=18V, T_C=100^\circ C$	5	A
$I_{D,pulse}$	Pulsed Drain Current	Pulse with t_p limited by T_{jmax}	10	A
P_{tot}	Power Dissipation	$T_C=25^\circ C, T_j=175^\circ C$	75	W
E_{AS}	Single pulse avalanche energy	$T_C=25^\circ C, L=0.5mH, I_{AS}=8.5A, V_{DD}=140V$	18	mJ
T_j	Operating Junction Temperature		-55~175	$^\circ C$
T_{stg}	Storage Temperature		-55~175	$^\circ C$
M_d	TO-247 mounting torque	M3 Screw	0.7	N·m

1) Note: When using MOSFET Body Diode $V_{GSmax}=-4/22V$

Electrical Characteristics (Defined at $T_j=25^\circ C$ unless otherwise specified)
Static Characteristics

Symbol	Parameter	Test conditions	Value			Unit
			Min.	Typ.	Max.	
$V_{(BR)DSS}$	Drain-Source Breakdown Voltage	$V_{GS}=0V, I_D=100\mu A$	1700			V
$V_{GS(th)}$	Gate Threshold Voltage	$V_{GS}=V_{DS}, I_D=0.5mA$	2.3	2.7	3.5	V
		$V_{GS}=V_{DS}, I_D=0.5mA, T_j=175^\circ C$		1.9		
I_{GSS}	Gate-Source Leakage Current	$V_{GS}=18V, V_{DS}=0V$			100	nA
I_{DSS}	Zero Gate Voltage Drain Current	$V_{DS}=1700V, V_{GS}=0V$		1	50	μA
		$V_{DS}=1700V, V_{GS}=0V, T_j=175^\circ C$		10	200	
$R_{DS(on)}$	Drain-Source On-State Resistance	$V_{GS}=18V, I_D=2A$		600	750	m Ω
		$V_{GS}=18V, I_D=2A, T_j=175^\circ C$		1230		
		$V_{GS}=15V, I_D=2A$		750		
g_{fs}	Transconductance	$V_{DS}=10V, I_D=2A$		1		S

Thermal Characteristics

Symbol	Parameter	Value			Unit
		Min.	Typ.	Max.	
$R_{th(jc)}$	Thermal Resistance from Junction to Case		2.00		K/W

AC Characteristics

Symbol	Parameter	Test conditions	Value			Unit
			Min.	Typ.	Max.	
C_{iss}	Input Capacitance	$V_{GS}=0V, V_{DS}=1000V$ $f=1MHz, V_{AC}=25mV$		170		pF
C_{oss}	Output Capacitance			11		pF
C_{rss}	Reverse Transfer Capacitance			2		pF
E_{oss}	C_{oss} Stored Energy			6.3		μJ
$C_{O(ER)}$	Effective Output Capacitance, Energy Related	$V_{GS}=0V, 0V < V_{DS} < 1000V$		12.7		pF
$C_{O(TR)}$	Effective Output Capacitance, Time Related	$V_{GS}=0V, 0V < V_{DS} < 1000V$		18		pF
$R_{G(int)}$	Internal Gate Resistance	$f=1MHz, V_{AC}=25mV$		30		Ω

Gate Charge Characteristics

Symbol	Parameter	Test conditions	Value			Unit
			Min.	Typ.	Max.	
Q_{GS}	Gate to Source Charge	$V_{DS}=1000V$ $I_D=2A$ $V_{GS}=-4/+18V$		2		nC
Q_{GD}	Gate to Drain Charge			11		nC
Q_G	Total Gate Charge			14		nC

Switching Characteristics

Symbol	Parameter	Test conditions	Value			Unit
			Min.	Typ.	Max.	
$t_{d(on)}$	Turn-On Delay Time	$V_{DC}=1000V, V_{GS}=-4/18V$ $I_D=2A, R_{G(ext)}=2.2\Omega$ $L_o=70nH, T_j=25^\circ C$ diode: body diode at $V_{GS}=-4V$ Inductive Load Eon includes diode reverse recovery		12		ns
t_r	Rise Time			24		ns
$t_{d(off)}$	Turn-Off Delay Time			20		ns
t_f	Fall Time			66		ns
E_{on}	Turn-On Energy			80		uJ
E_{off}	Turn-Off Energy			13		uJ
$t_{d(on)}$	Turn-On Delay Time		$V_{DC}=1000V, V_{GS}=-4/18V$ $I_D=2A, R_{G(ext)}=2.2\Omega$ $L_o=70nH, T_j=175^\circ C$ diode: body diode at $V_{GS}=-4V$ Inductive Load Eon includes diode reverse recovery		14	
t_r	Rise Time			22		ns
$t_{d(off)}$	Turn-Off Delay Time			24		ns
t_f	Fall Time			67		ns
E_{on}	Turn-On Energy			110		uJ
E_{off}	Turn-Off Energy			13		uJ

Reverse Diode Characteristics

Symbol	Parameter	Test conditions	Value			Unit
			Min.	Typ.	Max.	
V_{SD}	Diode Forward Voltage	$V_{GS}=-4V, I_{SD}=1A, T_j=25^\circ C$		5.2		V
		$V_{GS}=-4V, I_{SD}=1A, T_j=175^\circ C$		4.5		
I_{SD}	Continuous Diode Forward Current	$V_{GS}=-4V, T_c=25^\circ C$		6		A
$I_{SD,pulse}$	Pulse Diode Current	$V_{GS}=-4V$, pulse width t_p limited by T_{jmax}		9		A
t_{rr}	Reverse Recovery Time	$V_{GS}=-4V, V_{DC}=1000V, I_{SD}=2A$ $-di_F/dt=500A/\mu s$ $T_j=25^\circ C$		39		ns
Q_{rr}	Reverse Recovery Charge			42		nC
I_{rrm}	Peak Reverse Recovery Current			2		A
t_{rr}	Reverse Recovery Time	$V_{GS}=-4V, V_{DC}=1000V, I_{SD}=2A$ $-di_F/dt=500A/\mu s$ $T_j=175^\circ C$		38		ns
Q_{rr}	Reverse Recovery Charge			98		nC
I_{rrm}	Peak Reverse Recovery Current			3.5		A

Typical Performance

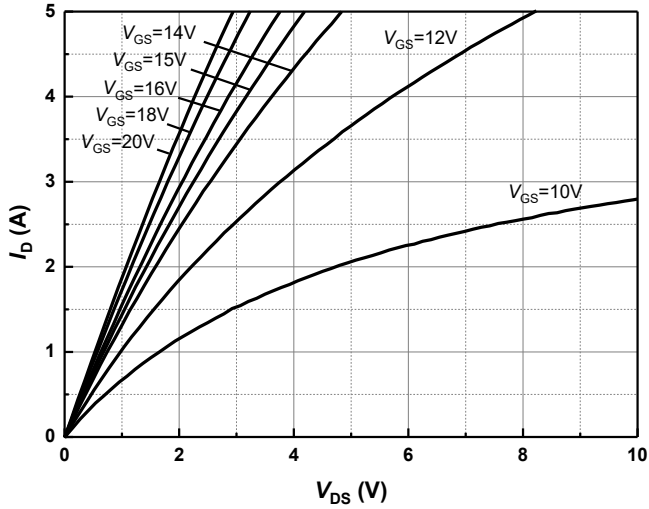

Figure 1 Typical Forward Output Characteristics at $T_j = 25^\circ\text{C}$

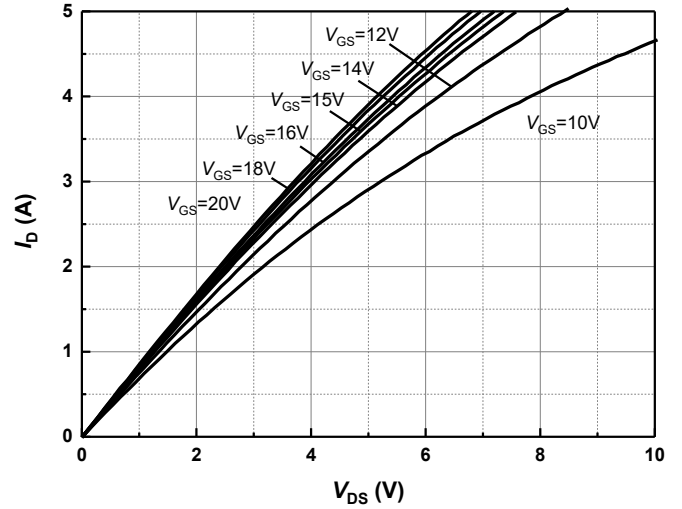

Figure 2 Typical Forward Output Characteristics at $T_j = 175^\circ\text{C}$

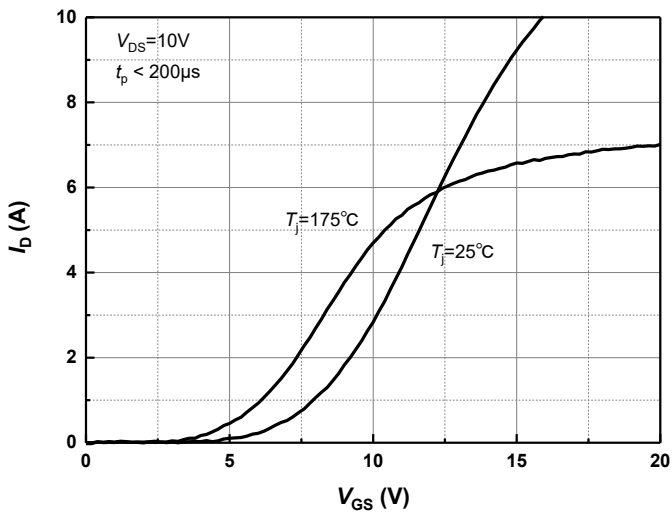

Figure 3 Transfer Characteristics for Various Temperature

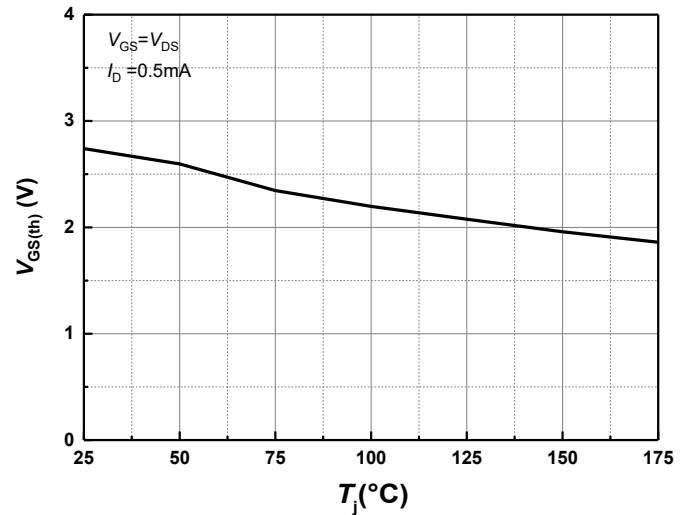

Figure 4 Threshold Voltage for Various Temperature

Typical Performance

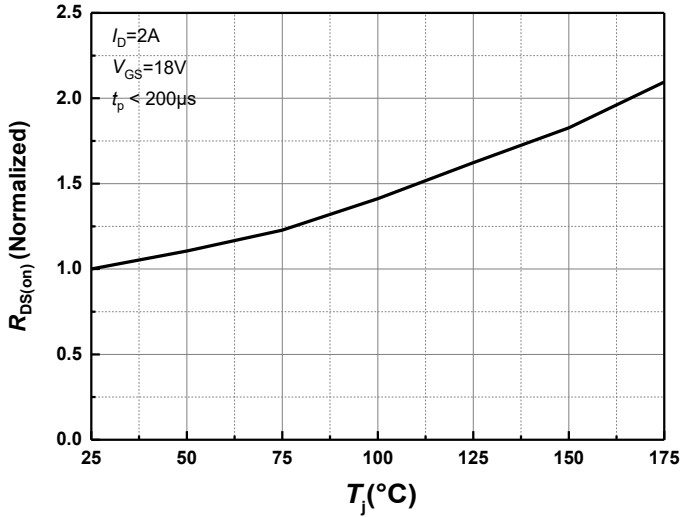

Figure 5 Normalized On-Resistance for Various Temperature

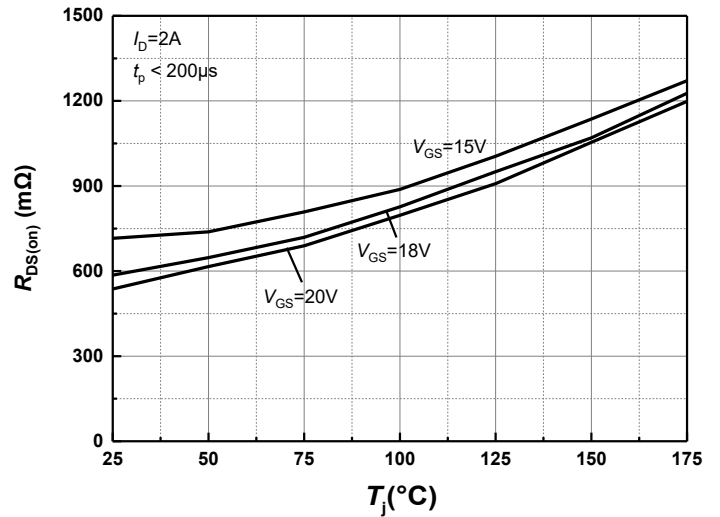

Figure 6 On-Resistance vs. Temperature for Various Gate-Source Voltage

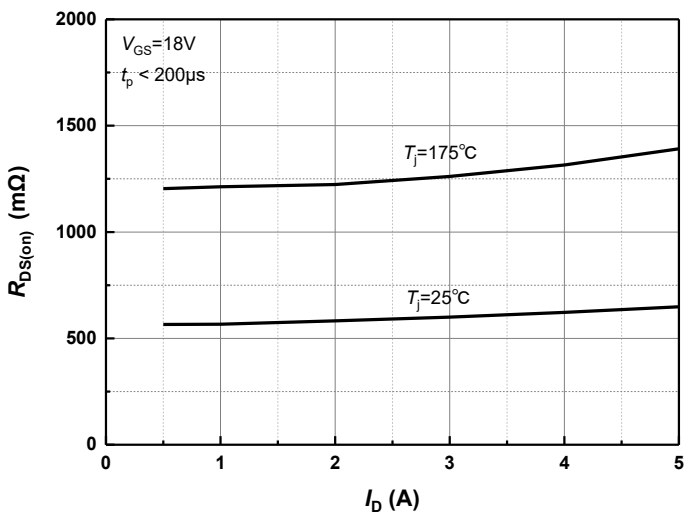

Figure 7 On-Resistance vs. Drain Current for Various Temperature

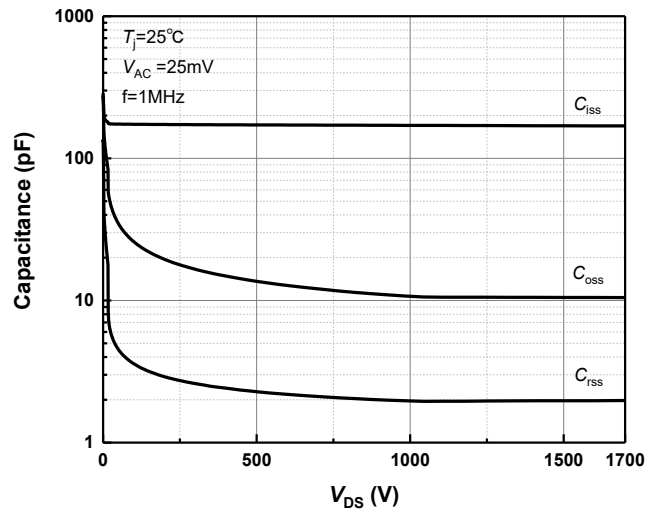

Figure 8 Capacitance vs. Drain-Source Voltage (0 - 1700V)

Typical Performance

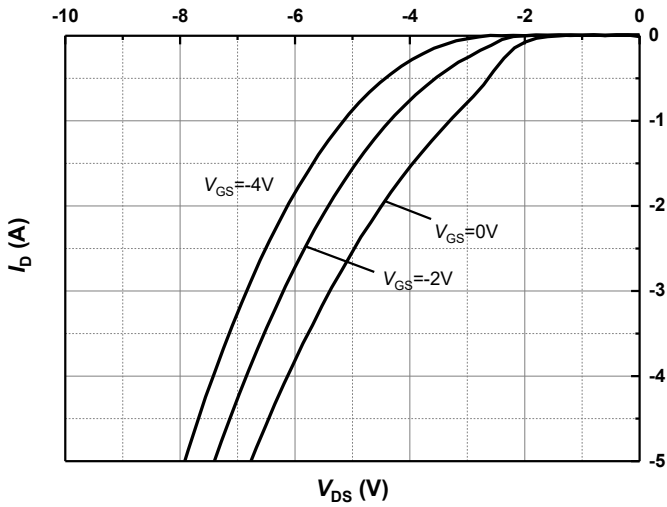

Figure 9 Body Diode Characteristics at $T_j=25^\circ\text{C}$

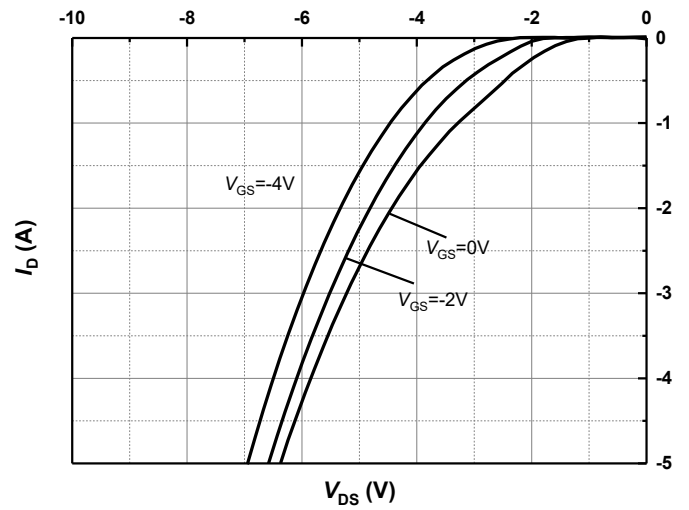

Figure 10 Body Diode Characteristics at $T_j=175^\circ\text{C}$

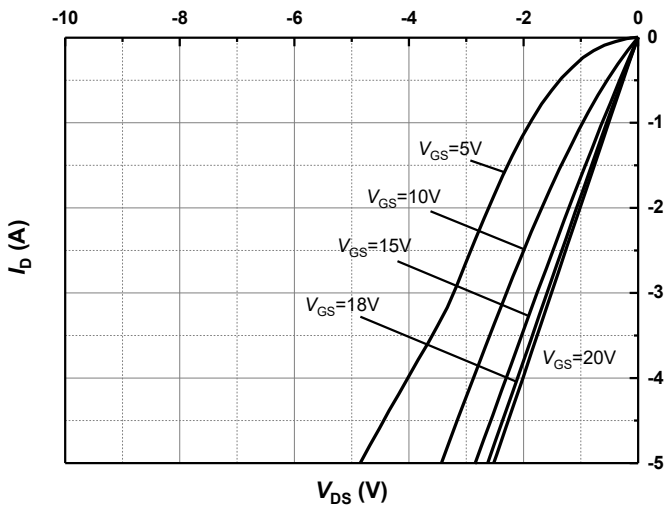

Figure 11 3rd Quadrant Characteristics at $T_j=25^\circ\text{C}$

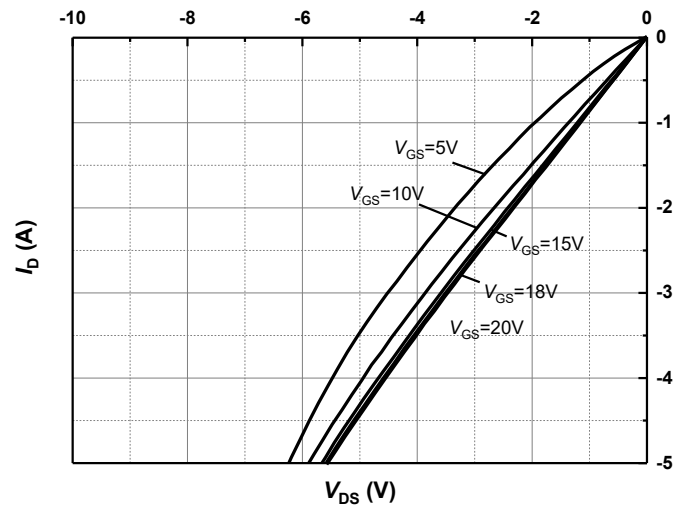

Figure 12 3rd Quadrant Characteristics at $T_j=175^\circ\text{C}$

Typical Performance

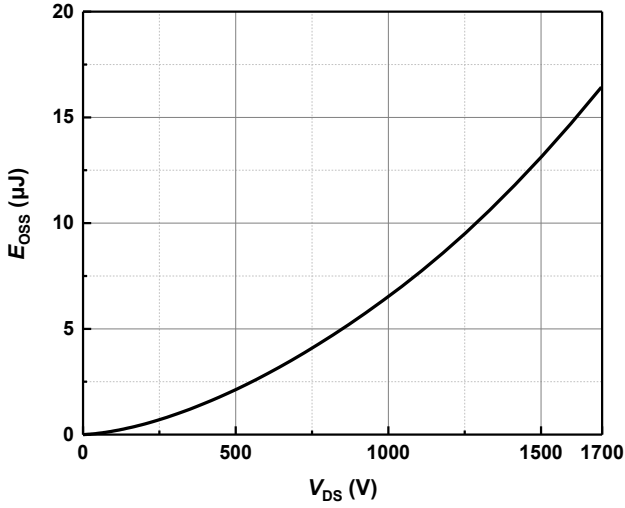

Figure 13 Output Capacitor stored Energy

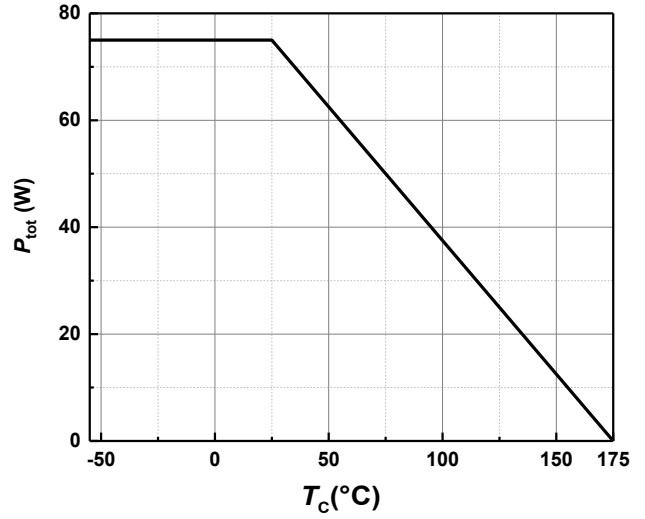

Figure 14 Maximum Power Dissipation Derating vs. Case Temperature

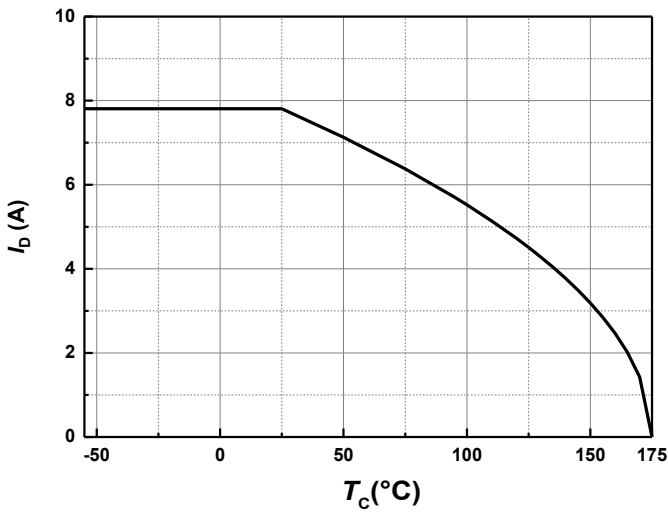

Figure 15 Continuous Drain Current Derating vs. Case Temperature

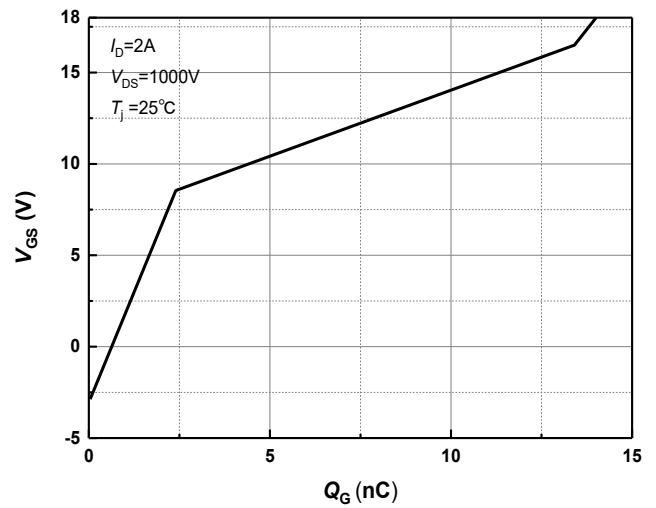

Figure 16 Gate Charge Characteristics

Typical Performance

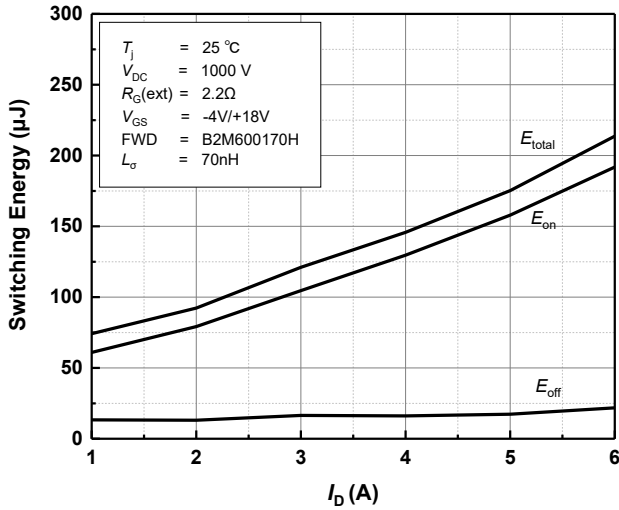

Figure 17 Clamped Inductive Switching Energy vs. Drain Current ($V_{DC} = 1000V$) at $T_j = 25^\circ C$

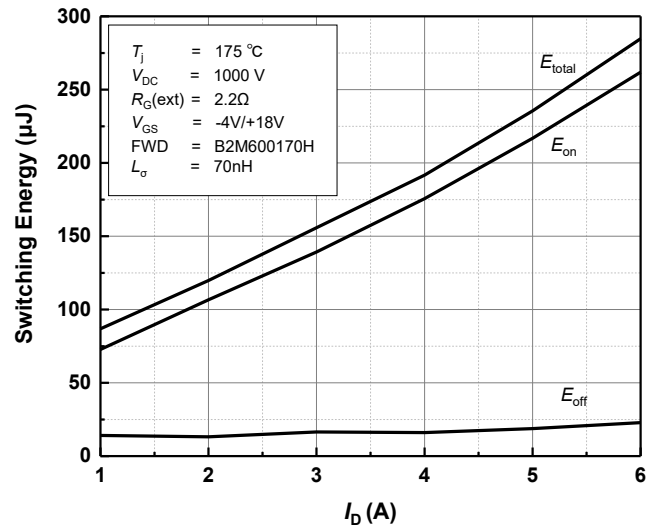

Figure 18 Clamped Inductive Switching Energy vs. Drain Current ($V_{DC} = 1000V$) at $T_j = 175^\circ C$

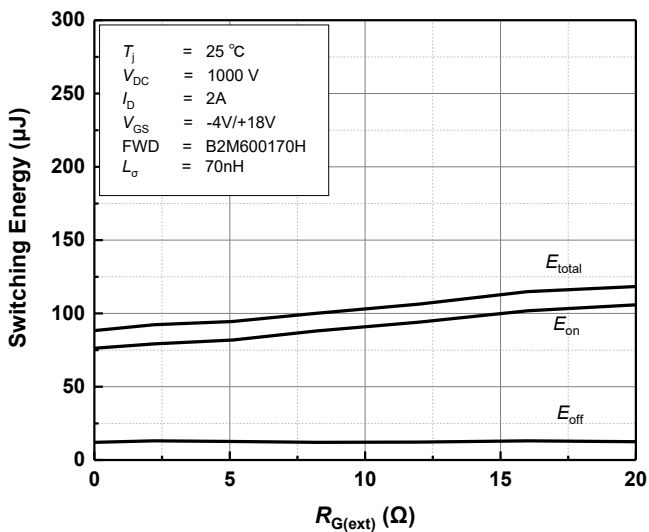

Figure 19 Clamped Inductive Switching Energy vs. External Gate Resistance at $T_j = 25^\circ C$

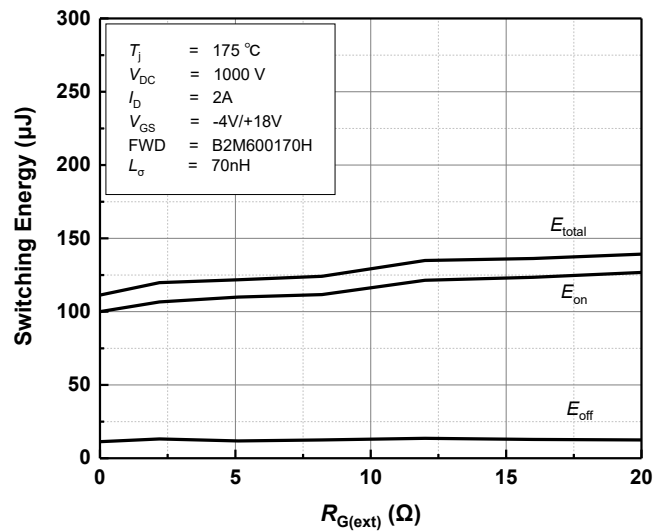

Figure 20 Clamped Inductive Switching Energy vs. External Gate Resistance at $T_j = 175^\circ C$

Typical Performance

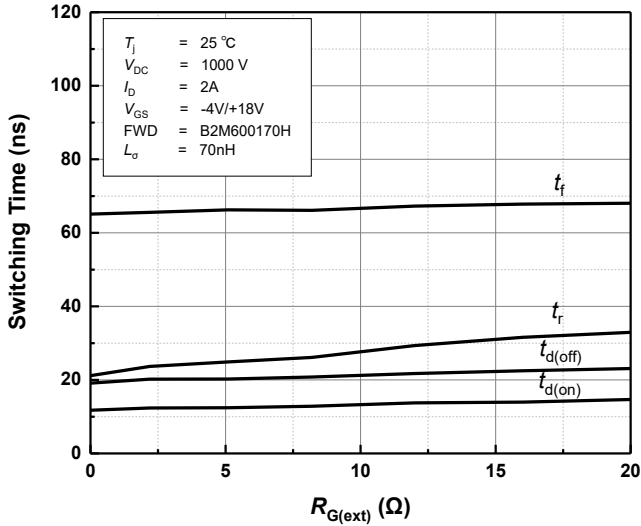

Figure 21 Clamped Inductive Switching Time vs. External Gate Resistance at $T_j=25^\circ\text{C}$

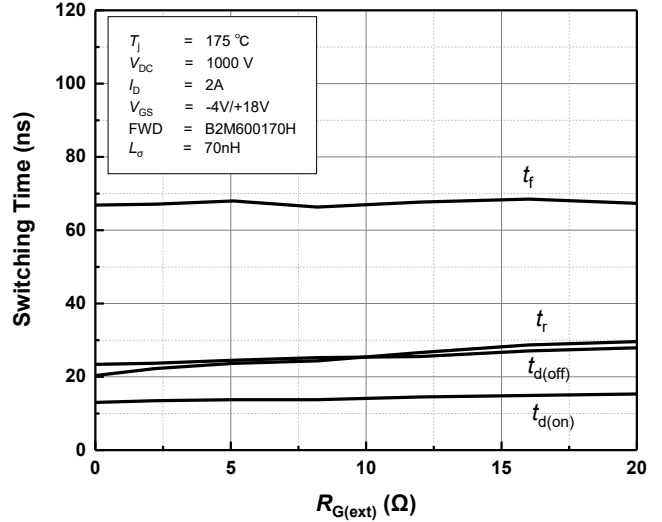

Figure 22 Clamped Inductive Switching Time vs. External Gate Resistance at $T_j=175^\circ\text{C}$

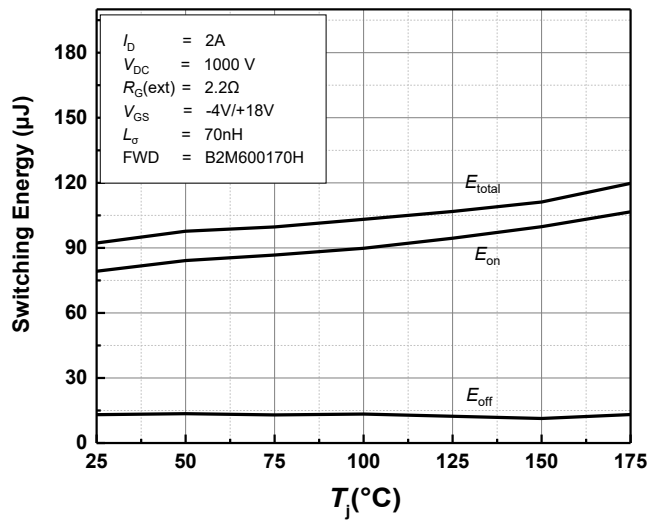

Figure 23 Clamped Inductive Switching Energy vs. Temperature

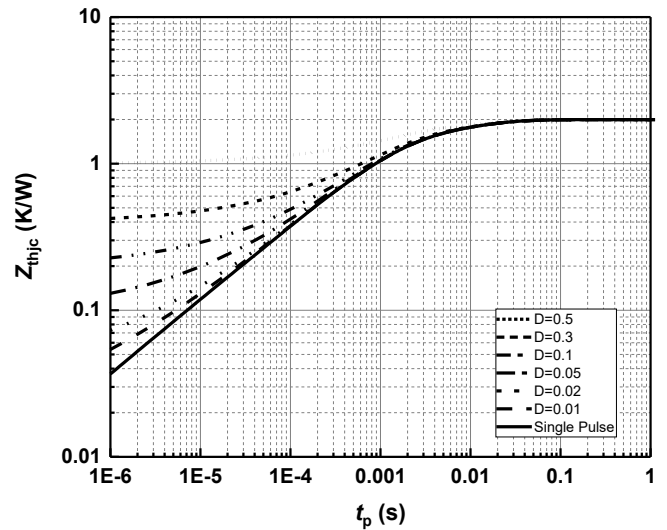

Figure 24 Transient Thermal Impedance (Junction - Case)

Typical Performance

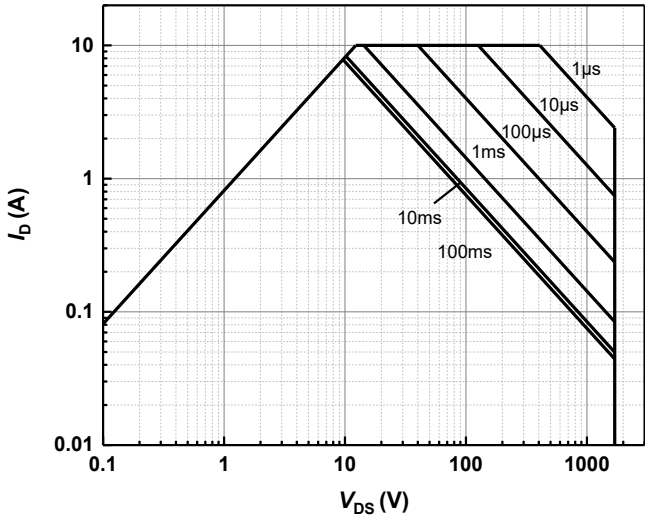
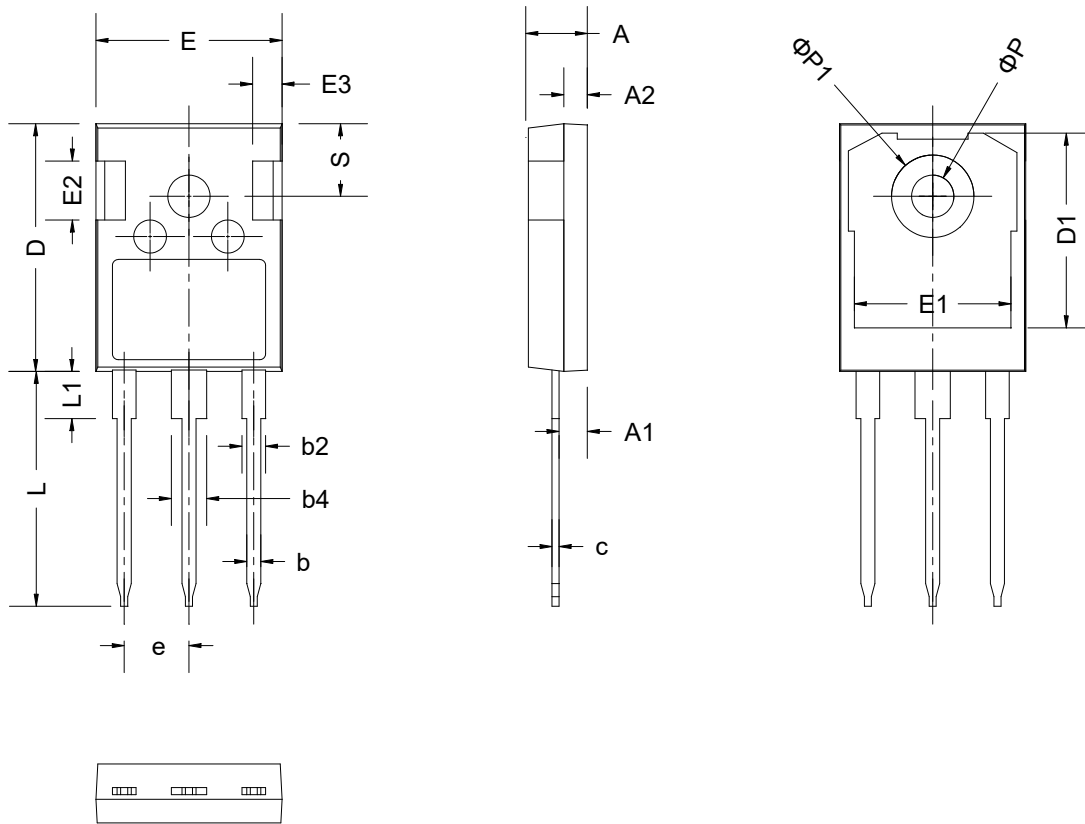

Figure 25 Forward Biased Safe Operating Area

Package Dimensions

SYMBOL	mm		
	MIN	NOM	MAX
A	4.80	5.00	5.20
A1	2.21	2.41	2.59
A2	1.85	2.00	2.15
b	1.11	1.21	1.36
b2	1.91	2.01	2.21
b4	2.91	3.01	3.21
c	0.51	0.61	0.75
D	20.80	21.00	21.30
D1	16.25	16.55	16.85
E	15.50	15.80	16.10
E1	13.00	13.30	13.60
E2	4.80	5.00	5.20
E3	2.30	2.50	2.70
e	5.44 BSC		
L	19.62	19.92	20.22
L1	-	-	4.30
ϕP	3.40	3.60	3.80
$\phi P1$	-	-	7.30
S	6.16 BSC		

Revision History

Document Version	Date of Release	Description of Changes
Rev. 0.0	2024-07-08	Draft datasheet created.

BASiC Semiconductor Ltd.
Shenzhen, China
© 2024 BASiC Semiconductor Ltd.
All Rights Reserved.

Information

For further information on technology, delivery terms and conditions and prices, please contact the nearest BASiC Semiconductor Office

Disclaimer

The information given in this document shall in no event be regarded as a guarantee of conditions or characteristics. With respect to any examples or hints given herein, any typical values stated herein and/or any information regarding the application of the device, BASiC semiconductor Ltd. hereby disclaims any and all warranties and liabilities of any kind, including without limitation, warranties of non-infringement of intellectual property rights of any third party.

单击下面可查看定价，库存，交付和生命周期等信息

[>>BASiC](#)