

BESP Series

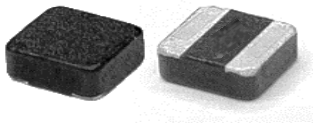

The series is designed specifically to enhance DDR5 application performance. Better ACR value at light load and the DCR value at heavy load.

Furthermore, the saturation current performance is also optimal, helping to reduce the ripple current and enhance the efficiency.

Features

- RoHS, Halogen Free and REACH Compliance
- Higher Isat and lower DCR \ ACR with smaller chip size
- Low coil resistance with large currents.
- High Efficiency

Applications

- Server
- Notebook
- SSD

Product Identification

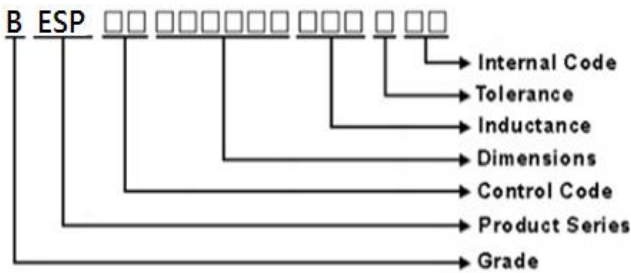

Shape and Dimensions

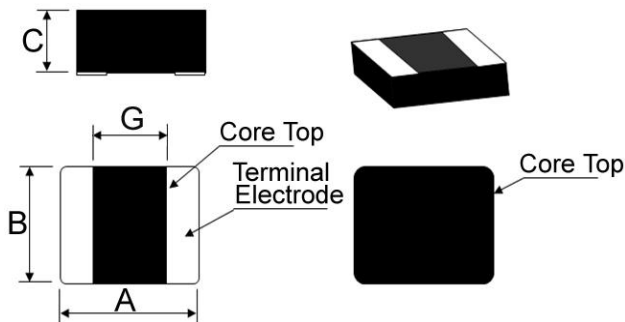

Recommended Pattern

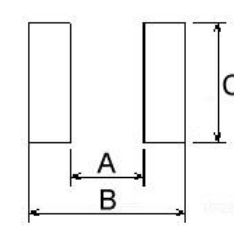

Dimensions in mm

TYPE	A	B	C	G
252012	2.5±0.2	2.0±0.2	1.2 Max	1.0 Typ
322512	3.2±0.2	2.5±0.2	1.2 Max	1.2 Typ

Dimensions in mm

TYPE	A	B	C
252012	1.0	2.7	2.2
322512	1.2	3.4	2.7

Molding Power Inductors – BESP Series

Electrical Characteristics

Part Number	Inductance (uH)	Tolerance (±%)	Test Frequency (MHz)	RDC(mΩ) Max(Typ)	Isat(A) Max(Typ)	Irms(A) Max(Typ)
BESP002520121R0MJS	1.00	20	1	28.0(25.0)	3.0(3.3)	4.2(4.7)
BESP002520121R5MJS	1.50	20	1	50.0(45.0)	2.4(2.7)	3.3(3.8)

Note: When ordering, please specify tolerance code. Tolerance: M=±20%

- Operating temperature range - 40°C ~ 125°C (Including self - temperature rise)
- Isat for Inductance drop 30% from its value without current
- Irms for a 40°C temperature rise from 25°C ambient with current
- Rated current : Isat or Irms, whichever is smaller
- Absolute maximum voltage 15VDC (Based on test method, it may not the same under different application, it is recommended to verify first.)

Test Instruments :

L : Agilent E4991/HP4286A+16197A/WP6500P (or equivalent), 1MHz 1V

RDC : CHEN HWA502BC/HP4338B (or equivalent)

Isat : Agilent E4980A+HP42841A (or equivalent)

Irms : Agilent 6641 SYSTEM DC POWER SUPPLY (or equivalent)

Inductance vs. DC Current

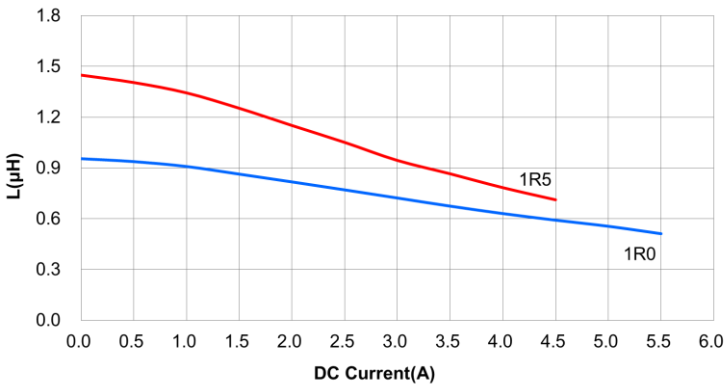

Temperature Change vs. DC Current

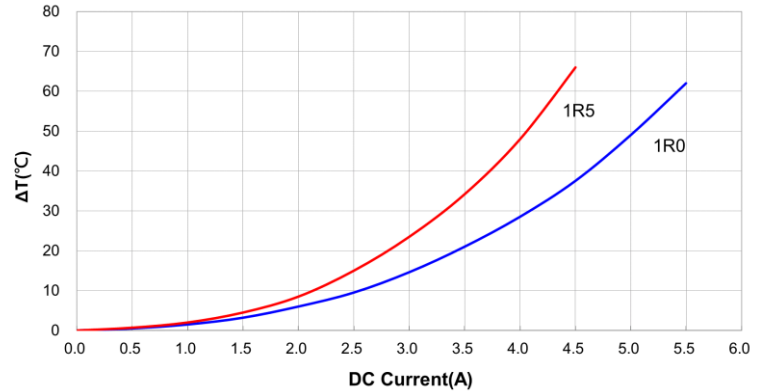

Molding Power Inductors – BESP Series

Electrical Characteristics

Part Number	Inductance (uH)	Tolerance (±%)	Test Frequency (MHz)	RDC(mΩ) Max(Typ)	Isat(A) Max(Typ)	Irms(A) Max(Typ)
BESP00322512R47MJS	0.47	20	1	12.0(10.5)	5.6(6.2)	6.0(6.5)
BESP00322512R68MJS	0.68	20	1	16.5(14.0)	4.2(4.6)	5.5(6.0)

Note: When ordering, please specify tolerance code. Tolerance: M=±20%

- Operating temperature range - 40°C ~ 125°C (Including self - temperature rise)
- Isat for Inductance drop 30% from its value without current
- Irms for a 40°C temperature rise from 25°C ambient with current
- Rated current : Isat or Irms, whichever is smaller
- Absolute maximum voltage 15VDC (Based on test method, it may not be the same under different application, it is recommended to verify first.)

Test Instruments :

L : Agilent E4991/HP4286A+16197A/WP6500P (or equivalent), 1MHz 1V

RDC : CHEN HWA502BC/HP4338B (or equivalent)

Isat : Agilent E4980A+HP42841A (or equivalent)

Irms : Agilent 6641 SYSTEM DC POWER SUPPLY (or equivalent)

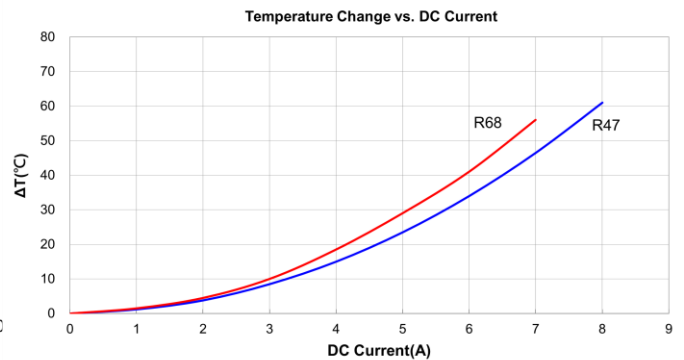
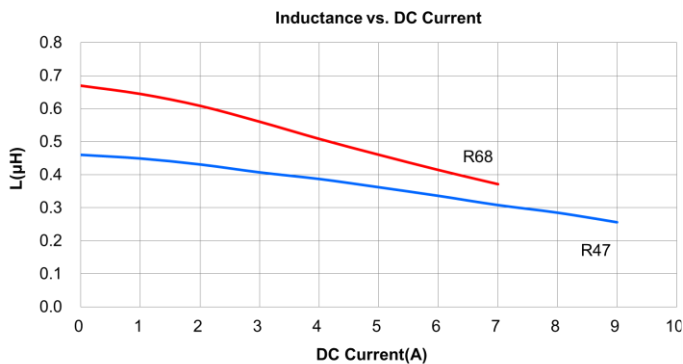

Packaging Specifications

Tape Dimensions

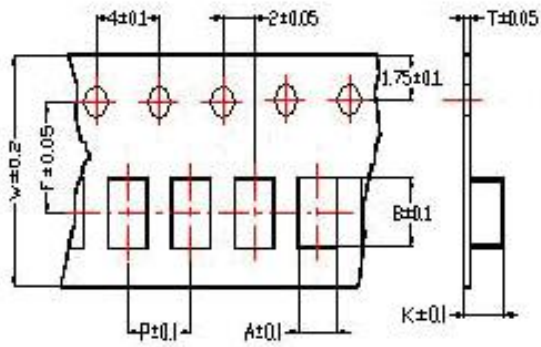

Tape Material

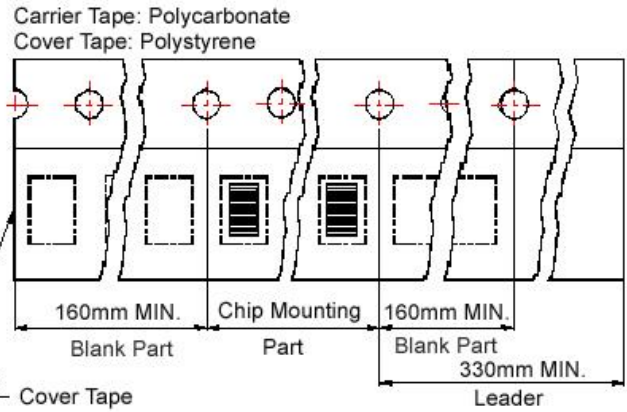

Reel Dimensions

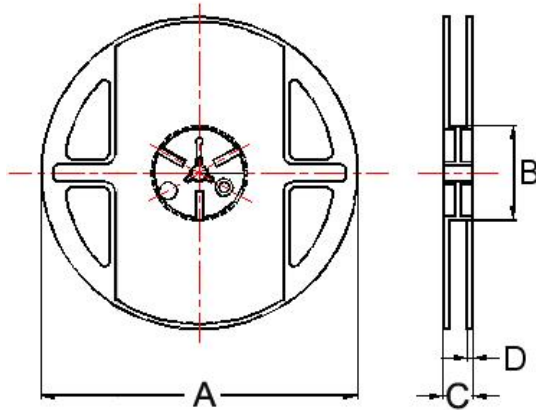

Dimensions in mm

TYPE	Tape Dimensions							Reel Dimensions				Quantity PCS / REEL
	A	B	T	W	P	F	K	A	B	C	D	
252012	2.35	2.90	0.25	8	4	3.5	1.35	178	60	12	1.5	3000
322512	2.85	3.50	0.25	8	4	3.5	1.35	178	60	12	1.5	2000

单击下面可查看定价，库存，交付和生命周期等信息

[>>CHILISIN\(奇力新\)](#)