

Rectifier module

Reverse Voltage - 800V to 1800V

Forward Current - 100A

Features

- ◆ Low reverse leakage current
- ◆ High surge current capability
- ◆ Compliant to RoHS directive 2011/65/EU

Applications

- ◆ Industrial power supply
- ◆ DC supply for PWM inverter
- ◆ Supplies for DC power equipment

Mechanical Data

- ◆ Case : M35
- ◆ Polarity: Polarity symbols being marked on body
- ◆ Mounting torque: 22.0 kgf.cm max

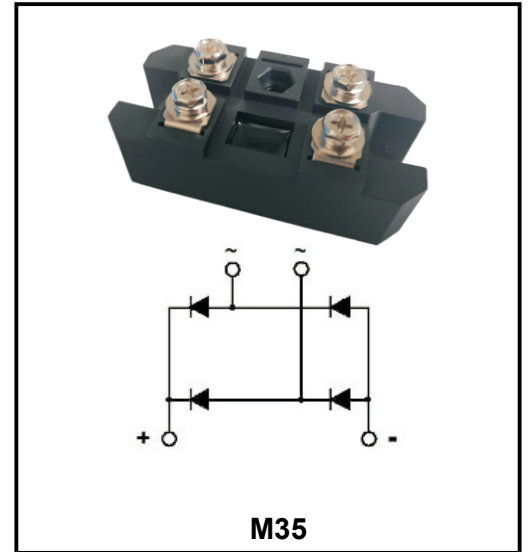

Maximum Ratings @ Ta = 25°C unless otherwise noted

Parameter	Symbols	MDQ100-08	MDQ100-10	MDQ100-12	MDQ100-16	MDQ100-18	Units
Maximum recurrent peak reverse voltage	V_{RRM}	800	1000	1200	1600	1800	V
Average rectified output current with heatsink, T _c =100°C	I_(AV)	100					A
Peak surge forward current, 8.3ms single half sine-wave superimposed on rated load	I_{FSM}	1020					A
Rating for fusing, 1ms<t<8.3ms, T _j =25°C, Rating of per diode	I²t	11220					A²S
Junction temperature	T_j	-40 ~ +150					°C
Storage temperature	T_{STG}	-40 ~ +125					°C
Dielectric, strength terminals to case AC 1 minute	V_{dis}	2.5					KV
Peak Forward Voltage I _F = 100A	V_F	1.2					V
Peak Reverse Current VR=VRRM, Pulse measurement Rating of per diode	T _j =25°C	0.5					mA
	T _j =125°C						
Maximum thermal resistance per leg	R_{θJC}	0.8					°C/W

Rating and Characteristic Curves

FIG1. Derating Curve For Output Rectified Current

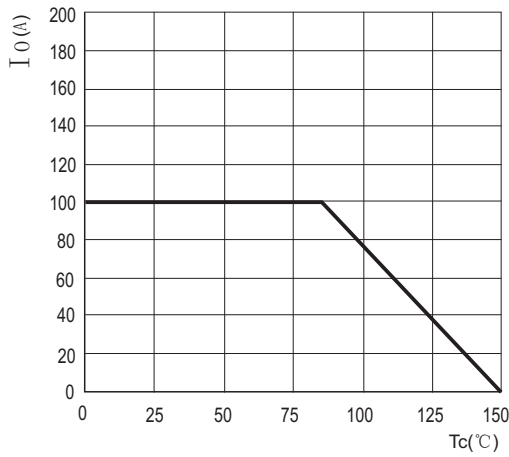

FIG2. Maximum Non-Repetitive Peak Forward Surge Current Per Bridge Element

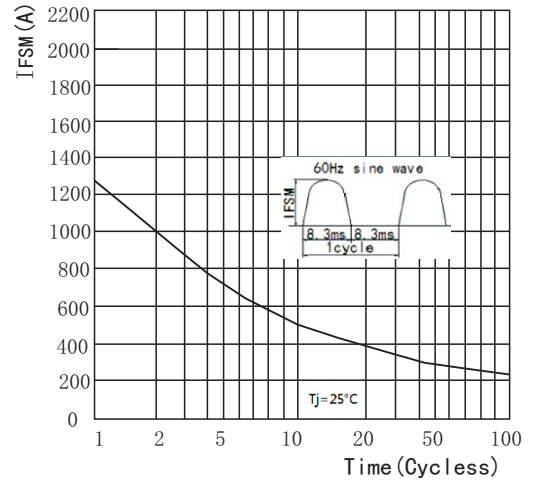

FIG3. Typical Reverse Characteristics Per Bridge Element

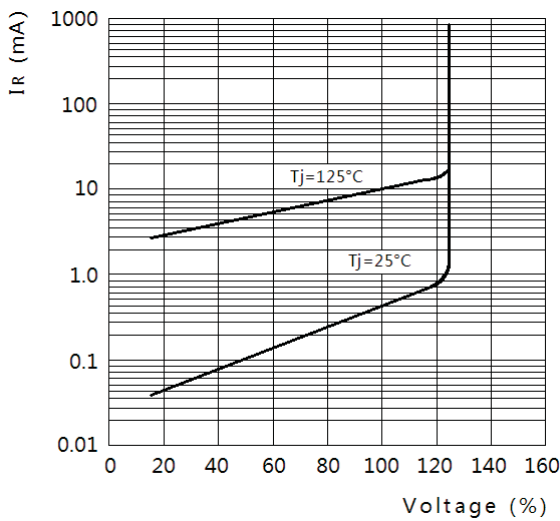
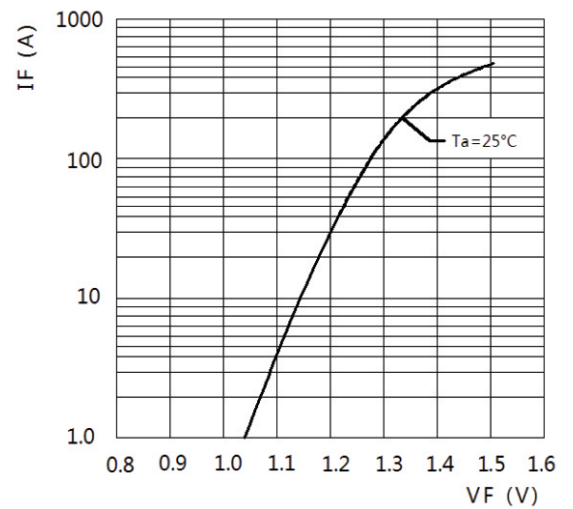
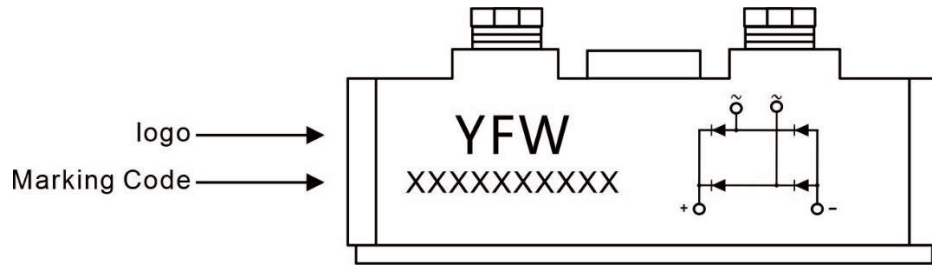

FIG4. Typical Forward Characteristics Per Bridge Element



Marking Diagram



Ordering information

Model name	Package	Unit Weight	Base Quantity
MDQ100-XX	M35	5.29oz(150g)	10pcs/ Box

Package Dimensions

M35

unit: Millimeter

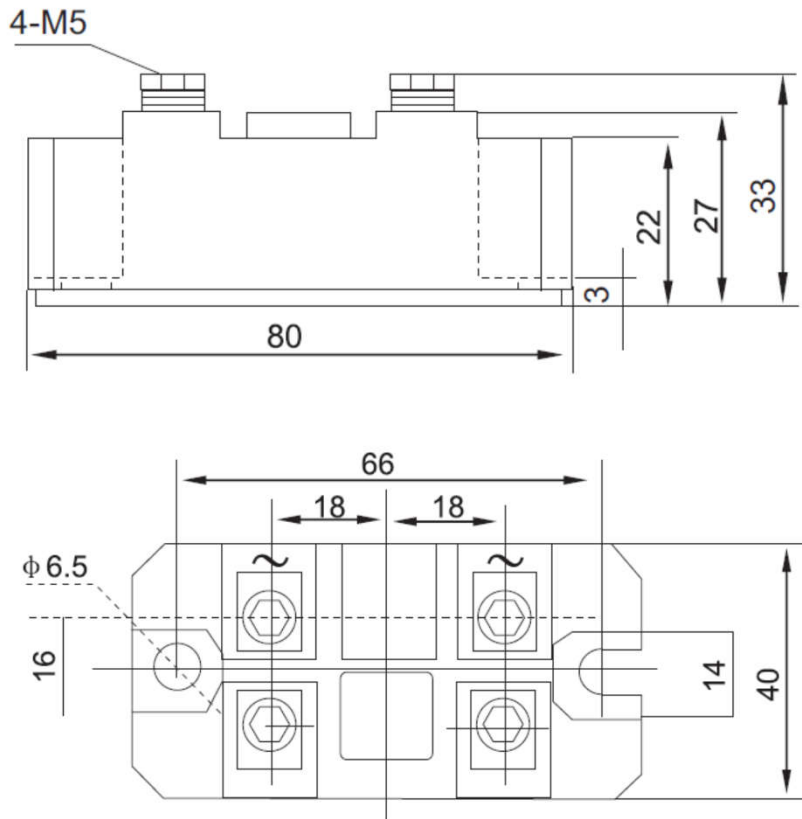

Disclaimer

The information presented in this document is for reference only. GuangDong Youfeng Microelectronics Co.,Ltd. reserves the right to make changes without notice for the specification of the products displayed herein to improve reliability, function or design or otherwise. The product listed herein is designed to be used with ordinary electronic equipment or devices, and not designed to be used with equipment or devices which require high level of reliability and the malfunction of with would directly endanger human life (such as medical instruments, transportation equipment, aerospace machinery, nuclear-reactor controllers, fuel controllers and other safety devices),YFW or anyone on its behalf, assumes no responsibility or liability for any damages resulting from such improper use of sale. This publication supersedes & replaces all information previously supplied. For additional information, please visit our website <https://www.yfwdiode.com>, or consult YFW sales office for further assistance.

单击下面可查看定价，库存，交付和生命周期等信息

[>>YFW\(佑风微\)](#)