

## Specification Sheet

□ Features

1. Save SMD surface area
2. Save SMD cost
3. Inverted Type (Reduce the open circuit)
4. Flat Terminal Type
5. RoHS Compliant.

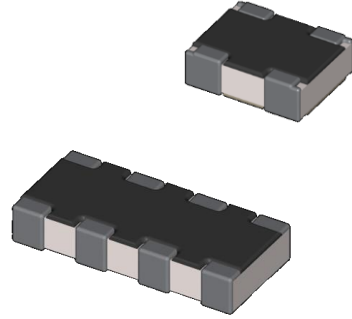

□ Part Number Description

<b>RF</b>		<b>06</b>		<b>4P</b>		<b>J</b>		<b>150</b>		<b>CS</b>	
Type (Series)		Size mm (inch)		# of Resistors		Tolerance		Resistance Value		Packing Type	
RF	Flat Array	06	0603 (0201)	2P	2 pieces	J	±5%	- 3-digit code (E-24 series) - Jumper : '000'		CS	7" reel
				4P	4 pieces	* Jumper : 'J'				ES	10" reel

□ Structure and Dimension

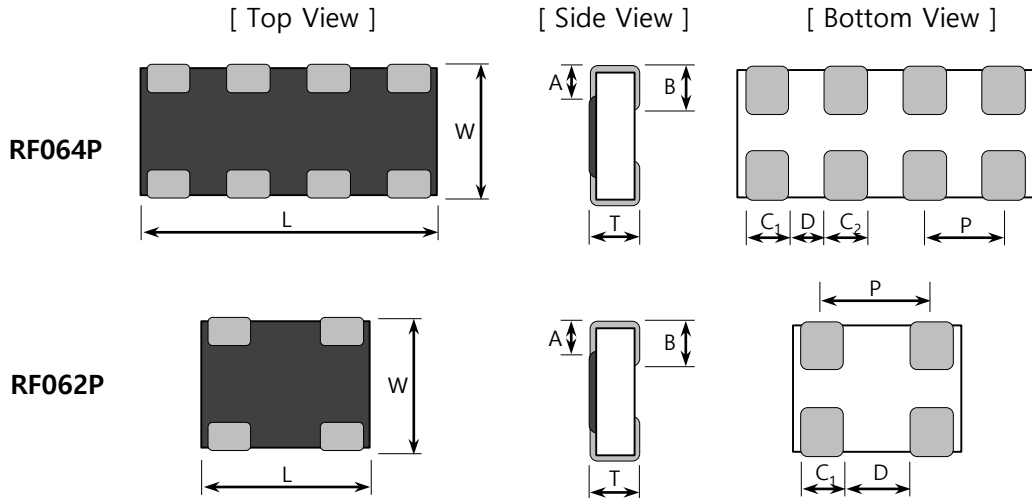

[ Unit : mm ]

Size : mm	L	W	T	A	B
RF062P	0.80±0.05	0.60±0.05	0.23±0.10	0.15±0.10	0.20±0.10
RF064P	1.40±0.05	0.60±0.05	0.23±0.10	0.15±0.10	0.20±0.10
	C <sub>1</sub>	C <sub>2</sub>	D	P	Weight(g/K)
	0.25±0.10	-	min 0.1	0.50±0.10	0.3mg
	0.25±0.10	0.25±0.10	min 0.1	0.40±0.10	0.5mg

□ Applications and Ratings

Type	Rated Power [W]	*MWV [V]	**MOV [V]	Tolerance [%]	T.C.R [ppm/°C]	Resistance Range [Ω]	Working Temp. [°C]
062P	1/32	12.5	25	±5.0(J)	±200	10~1M	-55~125
064P	1/32	12.5	25				

1) The rated voltage should follow the formula  $E = \sqrt{P \times R}$

In case the value exceeds the MWV, the MWV shall be regarded as the rated voltage

2) Moisture Level(1 Level)

3) \*Max Working Voltage

4) \*\*Max Overload Voltage

※ Please contact our sales representatives or engineers for other specifications

□ Rated Voltage

1. The rated voltage for resistor can be a DC continuous working voltage or AC(rms) voltage in commercial line frequency wave form at rated power. It can be expressed as below.

$$E = \sqrt{P \times R} \quad E : \text{Rated Voltage[V]} \quad P : \text{Rated Power[W]} \quad R : \text{Nominal Resistance[Ω]}$$

If the value calculated by the equation exceeds Max working Voltage, the rated voltage is limited to max working voltage. In other words, the lower value is the rated voltage.

ex) For RC1608 Series [ P=0.1(W), Max working voltage = 50(V) ]

1) The rated voltage, when R=1KΩ

$$E = \sqrt{0.1 \times 1000} = 10(V)$$

When the value is lower than MWV,

The Rated voltage is 10(V)

2) The rated voltage, when R=100KΩ

$$E = \sqrt{0.1 \times 100000} = 100(V)$$

When the value is higher than MWV,

The Rated voltage is equal MWV, as 50(V)

2. When the rated voltage is applied to the resistor, check the ambient temperature and decrease the lower according to the power derating curve.

3. If higher voltage than rated voltage, the reliability condition and performance cannot be guaranteed.

4. If pulse wave is applied, the maximum pulse power should be below the rated voltage.

Power Derating Curve

Rated power shall be the load power corresponding to nominal watt suitable for continuous use at  $70\pm 2^\circ\text{C}$  ambient temperature, In case the ambient temperature exceeds  $70\pm 2^\circ\text{C}$ , reduce the load power in accordance with the derating curve

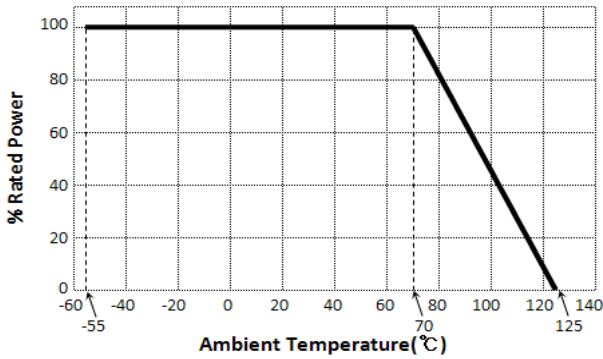

Jumper Ratings

Type	Rated Current[A]	Max Overload Current[A]	Resistance [ $\Omega$ ]	Working Temp.[ $^\circ\text{C}$ ]
062P 064P	0.5	1	Max 0.05	-55 ~ 125

Standard Soldering Land Pattern

[ 062P ]

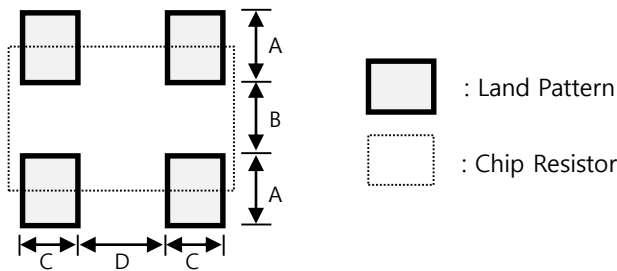

[ 064P ]

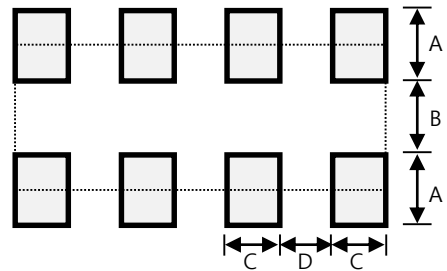

[ Unit : mm ]

Size			Reflow Soldering				
Type	mm	inch	A	B	2A+B	C	D
062P	0806	0302	0.30	0.30	0.90	0.20	0.30
064P	1406	0502	0.30	0.30	0.90	0.20	0.20

Performance characteristics

ITEM	Requirements Specification	Test Conditions (JIS C 5201-1)
Resistance	DC resistance value should be within the specified	JIS C 5201-1 4.5 Voltage apply within 5sec
Temperature Characteristic	TCR should be within the specified T.C.R	JIS C 5201-1 4.8 +20°C → -55°C / +20°C → +125°C
Short time Overload	$\Delta R$ should be within $\pm(1.0\%+0.1\Omega)$	JIS C 5201-1 4.13 2.5 times of rated voltage 5sec, 1cycle
Solderability	New solder coated more than 95% of termination	JIS C 5201-1 4.17 245+5/-0°C, 2±0.5 sec
Resistance to Solder Heat	$\Delta R$ should be within $\pm(1.0\%+0.05\Omega)$	JIS C 5201-1 4.18 Flow : Max 10sec (260°C, Both side dipping) Reflow : Max 10sec(230°C ↑, 30sec)
Temperature Cycle	$\Delta R$ should be within $\pm(1.0\%+0.1\Omega)$	JIS C 5201-1 4.19 -55°C ↔ +125°C, 100 cycle
Moisture Resistance	$\Delta R$ should be within $\pm(3.0\%+0.1\Omega)$	JIS C 5201-1 4.24 Rated Voltage, 40±2°C, 90~95%RH, 1,000 <sup>+48</sup> hours 90mins ON, 30mins OFF
Load Life	$\Delta R$ should be within $\pm(3.0\%+0.1\Omega)$	JIS C 5201-1 4.25 Rated Voltage, 70±2°C, 1,000 <sup>+48</sup> hours 90mins ON, 30mins OFF
High Temperature Exposure	$\Delta R$ should be within $\pm(3.0\%+0.1\Omega)$	JIS C 5201-1 4.23 155±2°C, 1,000 <sup>+48</sup> hours

※ The reliability test condition can be replaced by the corresponding accelerated test condition.

□ Taping & Packing

1. Quantity per Reel

Division	Size (Inch)	Thickness	Taping type	Pitch	7" Reel	13" Reel
Chip Resistor	062P (0302)	0.23 mm	Paper	2mm	20K	60K
	064P (0502)	0.23 mm	Paper	2mm	20K	60K

2. Cardboard(Paper) tape : 2mm pitch

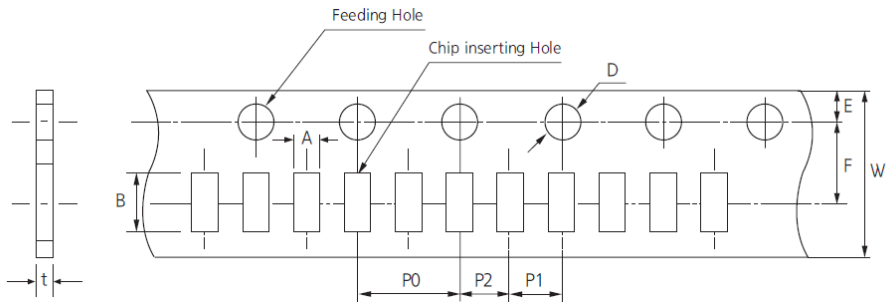

[ Unit : mm ]

Size (Inch)	A	B	W	F	E	P1	P2	P0	D	t
062P (0302)	0.70 ±0.10	0.90 ±0.10	8.00 ±0.10	3.50 ±0.05	1.75 ±0.10	2.00 ±0.05	2.00 ±0.05	4.00 ±0.10	φ1.50 +0.10 /-0.03	0.30 ±0.05
064P (0502)	0.70 ±0.10	1.60 ±0.10								0.30 ±0.05

※ According to normal size, we fill out A, B in the table above. The data may be varied with special size tolerance.

## 3. Reel Dimensions

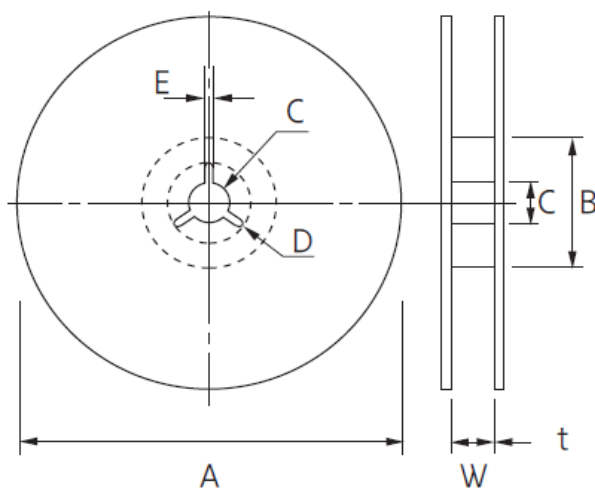

[ Unit : mm ]

Symbol	Tape Width	A	B	C	D	E	W	t
7" Reel	8mm	$\varphi 180^{+0/-3}$	$\varphi 60 \pm 1.0$	$\varphi 13.3 \pm 0.3$	$4 \pm 0.2$	$2.0 \pm 0.5$	$9 \pm 0.5$	$1.2 \pm 0.2$
	12mm	$\varphi 180^{+0/-3}$	$\varphi 60 \pm 1.0$	$\varphi 13.3 \pm 0.3$	$4 \pm 0.2$	$2.0 \pm 0.5$	$13 \pm 0.5$	$1.2 \pm 0.2$
10" Reel	8mm	$\varphi 258 \pm 3.0$	$\varphi 81 \pm 1.0$	$\varphi 13 \pm 0.3$	$4 \pm 0.2$	$2.0 \pm 0.5$	$9 \pm 0.5$	$1.8 \pm 0.2$
	12mm	$\varphi 258 \pm 3.0$	$\varphi 81 \pm 1.0$	$\varphi 13 \pm 0.3$	$4 \pm 0.2$	$2.0 \pm 0.5$	$13 \pm 0.5$	$1.8 \pm 0.2$
13" Reel	8mm	$\varphi 330 \pm 2.0$	$\varphi 100 \pm 1.0$	$\varphi 13 \pm 0.5$	$4 \pm 0.2$	$3.3 \pm 0.5$	$9 \pm 0.5$	$2.2 \pm 0.2$
	12mm	$\varphi 330 \pm 2.0$	$\varphi 80 \pm 1.0$	$\varphi 13 \pm 0.5$	$4 \pm 0.2$	$3.3 \pm 0.5$	$13 \pm 0.5$	$2.2 \pm 0.2$

## Precautions for Product Safety

1. The products are designed and produced for general electronic devices applications.  
User must contact our sales in-charge before using our products, if there is a risk to occur critical issues, such as casualties due to breakdown or malfunction of devices from application on products demanding high reliability or other safety devices, also for complicated products such as medical equipment, transportation equipment, an aircraft/spacecraft, an atomic energy controller, a fuel controller, automobile equipment, military equipment, disaster/crime preventive equipment.
2. The products are designed for use in the standard environment. Do not use products in specific environment that can affect a product performance. If you need to use products in the following conditions, please contact our sales in-charge in advance.
  - ① Various types of liquid including water, oil, organic solvent and other chemicals.
  - ② Direct sunlight, outdoors, or atmosphere with an amount of dusts.
  - ③ An amount of corrosive gases such as sea breeze, Cl<sub>2</sub>, H<sub>2</sub>S, NH<sub>3</sub>, SO<sub>2</sub>, NO<sub>2</sub>, and etc.
  - ④ Strong static electricity or electromagnetic waves
  - ⑤ Heat-producing components or inflammable materials are close.
  - ⑥ A resistor is sealed or coated with materials such as synthetic resin, and etc.
  - ⑦ Water or water-soluble detergent is used for cleaning free soldering or flux coating after
  - ⑧ Condensation phenomenon occurs on the object.
  - ⑨ Out of the range from -55 °C to +155(125) °C
3. The products have no radiation resistance.
4. It is a must to notify the person in charge of sales of issues on product safety at any time.  
In addition, a regular monitor for product safety should be conducted by customers.

## Precautions regarding the use of products.

1. Product characteristics must be evaluated on a board mounted.
2. When transitory load is used in which short-time load is applied such as pulse, a resistor should be tested on a board mounted. If load is higher than rated voltage under the load conditions at continuous steps, it causes damages on characteristics or reliability of the resistor. Therefore, when load exceed the rated voltage, it is not allowed to apply.
3. It is not recommended to use halogen products such as chlorine (Cl), bromine (Br), etc. or fluxes that are highly active due to the residue that is able to affect the characteristics or reliability of a resistor.
4. Be careful with the soldering condition to avoid the Ag-solder penetration problems.

5. When soldering manually, do not touch a resistor body with the edge of soldering iron directly. When working with a soldering iron at high temperature, please be done with the work as quick as possible.
6. Physical shocks to the resistor can cause the breaking of protective layers of the product and affect its characteristic adversely. Therefore, use caution when picking and moving Chip-R with hard instruments such as metal tweezers in order to avoid damages on a resistor or degradation of product performance degradation.
7. Do not soak the resistor in a solvent for a long time. Also, the effect of solvent must be checked prior to use.
8. Place products carefully to keep the standard temperature range in the category, otherwise increasing temperature caused by adjacent heat-generating components can exceed the temperature range. In addition, do not place or install heat-emitting components or flammable materials such as plastic coating wires near these products.
9. Safety can be guaranteed only when average power is lower than rated power, and if power exceeding the rated power is applied, please make sure to make an inquire on surge voltage or a current waveform for a short time.

Recommendation for temperature/humidity

Even taping and packaging materials are designed to endure a long-term storage, they should be stored with a temperature of 0~40°C and an RH of 0~70% otherwise, too high temperatures or humidity may deteriorate the quality of the product rapidly.

As oxidization is accelerated when relative humidity is above 70%RH, the lower the humidity is, the better the solderability is.

As the temperature difference may cause dew condensation during the storage of the product, it is a must to maintain a temperature control environment.

Shelf life

An allowable storage period should be within 6 months from the outgoing date of delivery in consideration of solderability.

It can be stored for a long time in vacuum at room temperature, but if vacuum condition is not available, it is recommended to be stored in a dry condition inside desiccator.

As for products in storage over 6 months, please check solderability before use.



-  1. The product specifications are subject to change, modify or suspend at any time without prior notice by our company. Hence, it is a must to get approval of the product specifications before making orders for products. For more inquires on the product specifications, please contact our sales in-charge or engineer (AE).
2. Without our permission, any copies, duplications, use or transmission of contents or information contained in this specification (catalog) for any purpose are prohibited.
3. No responsibility shall be held for any claims, disputes, damages or liabilities arising from or related to the misuse of the Products and or information contained in this Specification (Catalog). In addition, regarding the use of the products and information contained in this Specification (Catalog), no liability shall be held for any claims, disputes, damages or liabilities relating to our or any third party ' s intellectual property rights or other related rights.
4. Bilateral discussions shall be required in case there are unmarked or uncertain parts in the specification (catalog).

单击下面可查看定价，库存，交付和生命周期等信息

[>>Samsung Electro-Mechanics\(三星电机\)](#)