

Specification for Approval

Date: 2022/11/19

Customer : _____

TAI-TECH P/N: TMPF0402AV-Series(N)-ABD-HD

CUSTOMER P/N: _____

DESCRIPTION: _____

QUANTITY: _____ pcs

REMARK:		
Customer Approval Feedback		

西北臺慶科技股份有限公司
 TAI-TECH Advanced Electronics Co., Ltd
Headquarter:
 NO.1 YOU 4TH ROAD, YOUTH INDUSTRIAL DISTRICT, YANG-MEI,
 TAO-YUAN HSIEN, TAIWAN, R.O.C.
 TEL: +886-3-4641148 FAX: +886-3-4643565
 http://www.tai-tech.com.tw
 E-mail: sales@tai-tech.com.tw

Sales Dep.

APPROVED	CHECKED
Eric Kuan	Zhang mengmeng

臺慶精密電子(昆山)有限公司
 TAI-TECH ADVANCED ELECTRONICS(KUNSHAN) CO., LTD
 SHINWHA ROAD, KUNJIA HI-TECH INDUSTRIAL PARK, KUN-SHAN,
 JIANG-SU, CHINA
 TEL: +86-512-57619396 FAX: +86-512-57619688
 E-mail: sales@tai-tech.cn

R&D Center

APPROVED	CHECKED	DRAWN
Sky Luo	Mr.Liang	Cui lingling

慶邦電子元器件(泗洪)有限公司
 TAIPAQ ELECTRONICS (SIHONG) CO., LTD
 JIN SHA JIANG ROAD , CONOMIC DEVELOPMENT ZONE SIHONG ,
 JIANGSU , CHINA.
 TEL: +86-527-88601191 FAX: +86-527-88601190
 E-mail: sales@taipaq.cn

SMD Power Inductor

TMPF0402AV-Series(N)-ABD-HD

1. Features

1. Low loss realized with low DCR.
2. High performance realized by metal dust core.
3. Ultra low buzz noise, due to composite construction.
4. 100% Lead(Pb)-Free and RoHS compliant.
5. High reliability -Reliability test complied to AEC-Q200.



2. Applications

Automotive applications.

3. Dimensions

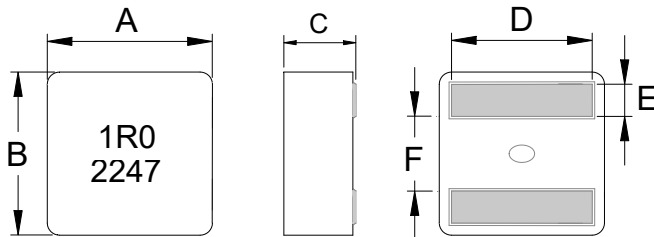

Recommend PC Board Pattern

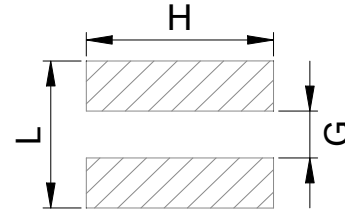

L(mm)	G(mm)	H(mm)
3.4 ref	1.4 ref	3.8 ref

Note: 1.PCB layout is referred to standard IPC-7351B
 2. The above PCB layout reference only.
 3. Recommend solder paste thickness at 0.12mm and above.

Series	A (mm)	B (mm)	C (mm)	D (mm)	E (mm)	F (mm)
TMPF0402AV-ABD	4.4±0.2	4.4±0.2	1.9±0.2	3.4±0.3	0.88±0.2	1.6±0.25

4. Part Numbering



- A: Series
 - B: Dimension
 - C: Type
 - D: Inductance
 - E: Inductance Tolerance
 - F: Date Code
 - G: Code
- Material:
 1R0=1.00uH
 M=±20%
 Marking: Black.1R0 and 2247(22YY,47 WW, follow production date).
 AB:oversize

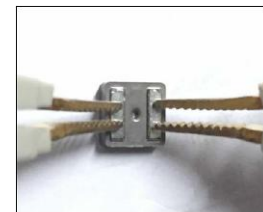

DCR Test

5. Specification

Part Number	Inductance (μH) $\pm 20\%$ @ 0 A	I rms (A) Typ		I sat (A)		DCR ($\text{m}\Omega$) Typ	DCR ($\text{m}\Omega$) Max
		20°C rise	40°C rise	Typ	Max		
TMPF0402AV-R10MN-ABD-HD	0.10	13.5	18.0	38.0	33.0	2.2	2.42
TMPF0402AV-R22MN-ABD-HD	0.22	13.0	16.8	19.5	18.8	4.1	4.6
TMPF0402AV-R33MN-ABD-HD	0.33	12.0	15.5	18.0	16.5	5.0	5.5
TMPF0402AV-R36MN-ABD-HD	0.36	11.0	14.5	17.0	15.0	5.6	6.3
TMPF0402AV-R40MN-ABD-HD	0.40	10.0	14.0	15.5	13.5	6.9	7.73
TMPF0402AV-R47MN-ABD-HD	0.47	9.0	12.5	14.5	13.0	7.8	8.58
TMPF0402AV-R56MN-ABD-HD	0.56	8.5	12.0	14.0	12.6	8.4	9.3
TMPF0402AV-R60MN-ABD-HD	0.60	8.0	11.7	13.7	12.3	8.6	9.52
TMPF0402AV-R72MN-ABD-HD	0.72	7.6	10.5	12.0	10.6	10.4	11.6
TMPF0402AV-1R0MN-ABD-HD	1.00	6.8	9.6	9.6	8.8	13.3	14.6
TMPF0402AV-1R2MN-ABD-HD	1.20	6.6	9.0	9.0	7.8	16.2	17.9
TMPF0402AV-1R5MN-ABD-HD	1.50	5.8	7.6	8.0	7.4	21.0	23.5
TMPF0402AV-1R8MN-ABD-HD	1.80	5.2	7.0	7.5	7.0	25.0	28.0
TMPF0402AV-2R2MN-ABD-HD	2.20	4.6	5.6	6.5	6.0	35.2	38.7

Note:

1. Test frequency : L : 100KHz /0.1V.
2. All test data referenced to 25°C ambient.
3. Testing Instrument(or equ) : Agilent 4284A,E4991A,4339B,KEYSIGHT E4980A/AL,chroma3302,3250,16502.
4. Current that causes the specified temperature rise from 25° C ambient.
5. Saturation Current (Isat) will cause L0 to drop approximately 30%.
6. The part temperature (ambient + temp rise) should not exceed 155°C under worst case operating conditions.Circuit design,component,PCB trace size and thickness,airflow and other cooling provisions all affect the part temperature. Part temperature should be verified in the end application.
7. Irms Testing : Temperature rise is highly dependent on many factors including pcb land pattern, trace size, and proximity to other components. Therefore temperature rise should be verified in application conditions.
8. Rated operating voltage(across inductor) 15V ref (1.5 μH and above) .
Rated operating voltage(across inductor) 40V ref (1.2 μH and below).
9. Rated DC current: The lower value of Irms and Isat.

6. Material List

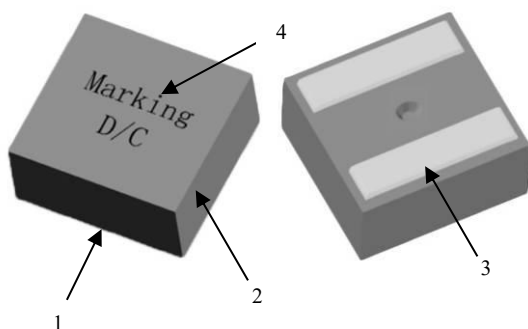

NO	Items	Materials
1	Core	Alloy powder.
2	Wire	Polyester Wire or equivalent.
3	Solder	100% Pb free solder
4	Ink	Halogen-free ketone

7. Packaging Information

(1) Reel Dimension

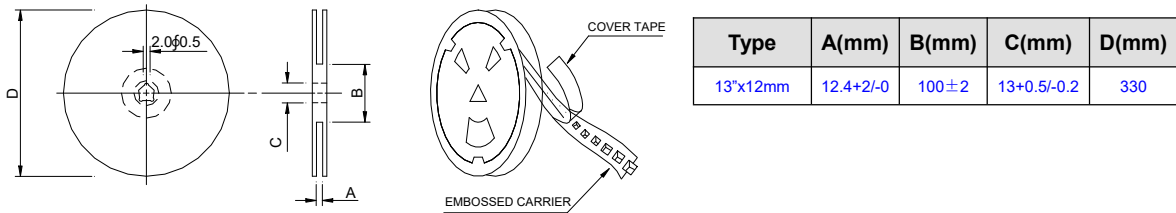

(2) Tape Dimension

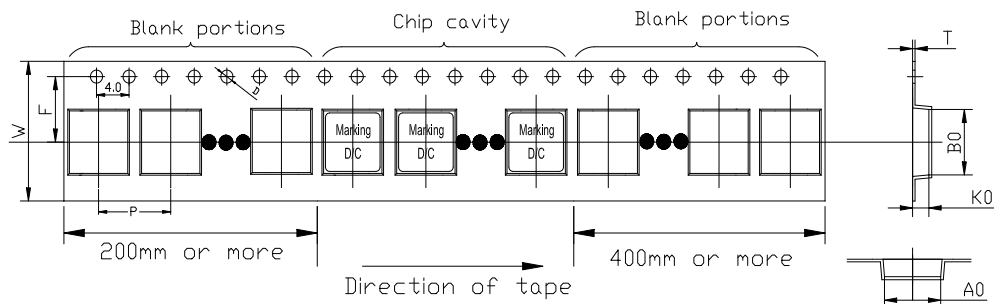

Series	Size	Bo(mm)	Ao(mm)	Ko(mm)	P(mm)	W(mm)	F(mm)	T(mm)	D(mm)
TMPF	0402	4.7±0.1	4.7±0.1	2.3±0.1	8.0±0.1	12±0.3	5.5±0.1	0.35±0.1	1.5±0.1

(3) Packaging Quantity

TMPF	0402
Chip / Reel	3000

(4) Tearing Off Force

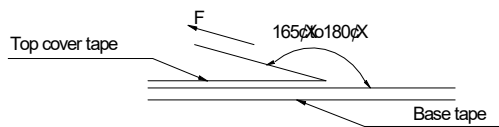

The force for tearing off cover tape is 10 to 130 grams in the arrow direction under the following conditions(referenced ANSI/EIA-481-D-2008 of 4.11 standard).

Tearing Speed mm	Room Temp. (°C)	Room Humidity (%)	Room atm (hPa)
300 ± 10%	5~35	45~85	860~1060

8. Reliability and Test Condition

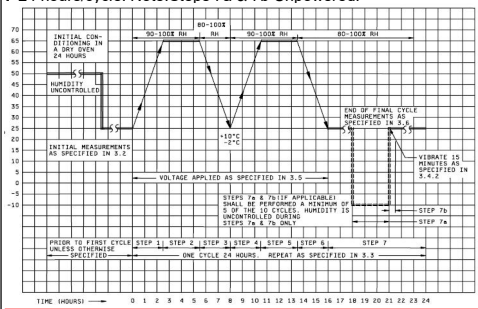
Item	Performance	Test Condition															
Operating temperature	-55~+155℃(Including self - temperature rise)																
Storage temperature and Humidity range	1. -10~+40℃,50~60%RH (Product with taping) 2. -55~+155℃(on board)																
Electrical Performance Test																	
Inductance	Refer to standard electrical characteristics list.	HP4284A,CH11025,CH3302,CH1320,CH1320S LCR Meter.															
DCR		CH16502,Agilent33420A Micro-Ohm Meter.															
Saturation Current (Isat)	Approximately ΔL30%	Saturation DC Current (Isat) will cause L0 to drop ΔL(%)															
Heat Rated Current (Irms)	Approximately ΔT20℃&ΔT40℃	Heat Rated Current (Irms) will cause the coil temperature rise ΔT(℃). 1.Applied the allowed DC current 2.Temperature measured by digital surface thermometer															
Reliability Test																	
High Temperature Exposure(Storage) AEC-Q200		Preconditioning: Run through IR reflow for 3 times.(IPC/JEDEC J-STD-020E Classification Reflow Profiles Temperature: 155±2℃ (Inductor) Duration : 1000hrs Min. Measured at room temperature after placing for 24±2 hrs															
Temperature Cycling AEC-Q200		Preconditioning: Run through IR reflow for 3 times.(IPC/JEDEC J-STD-020E Classification Reflow Profiles Condition for 1 cycle Step1: -55±2℃ 30min Min.(Inductor) Step2: 155±2℃ transition time 1min MAX. Step3: 155±2℃ 30min Min. Step4: Low temp. transition time 1min MAX. Number of cycles: 1000 Measured at room temperature after placing for 24±2 hrs															
Moisture Resistance (AEC-Q200)	Appearance: No damage. Inductance: within±10% of initial value RDC: within ±15% of initial value and shall not exceed the specification value	t=24 hours/cycle. Note:Steps 7a & 7b Unpowered. 															
Biased Humidity (AEC-Q200)		Preconditioning: Run through IR reflow for 3 times. (IPC/JEDEC J-STD-020E Classification Reflow Profiles) Humidity : 85±3% R.H, Temperature: 85℃±2℃ Duration : 1000hrs Min Measured at room temperature after placing for24±2hrs															
High Temperature Operational Life (AEC-Q200)		Preconditioning: Run through IR reflow for 3 times. (IPC/JEDEC J-STD-020E Classification Reflow Profiles Temperature: 155±2℃ (Inductor) Duration : 1000hrs Min. With 100% rated current. Measured at room temperature after placing for24±2hrs															
External Visual	Appearance: No damage.	Inspect device construction, marking and workmanship. Electrical Test not required.															
Physical Dimension	According to the product specification size measurement	According to the product specification size measurement															
Resistance to Solvents	Appearance: No damage.	Add aqueous wash chemical - OKEM clean or equivalent.															
Mechanical Shock	Appearance: No damage. Inductance: within±10% of initial value RDC: within ±15% of initial value and shall not exceed the specification value	Preconditioning: Run through IR reflow for 3 times.(IPC/JEDEC J-STD-020E Classification Reflow Profiles) Test condition <table border="1" data-bbox="949 1787 1417 1910"> <thead> <tr> <th>Type</th> <th>Peak value (g's)</th> <th>Normal duration (D) (ms)</th> <th>Wave form</th> <th>Velocity change (Vi)ft/sec</th> </tr> </thead> <tbody> <tr> <td>SMD</td> <td>100</td> <td>6</td> <td>Half-sine</td> <td>12.3</td> </tr> <tr> <td>Lead</td> <td>100</td> <td>6</td> <td>Half-sine</td> <td>12.3</td> </tr> </tbody> </table> 3 shocks in each direction along 3 perpendicular axes(18 shocks).	Type	Peak value (g's)	Normal duration (D) (ms)	Wave form	Velocity change (Vi)ft/sec	SMD	100	6	Half-sine	12.3	Lead	100	6	Half-sine	12.3
Type	Peak value (g's)	Normal duration (D) (ms)	Wave form	Velocity change (Vi)ft/sec													
SMD	100	6	Half-sine	12.3													
Lead	100	6	Half-sine	12.3													

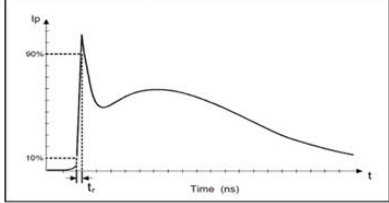
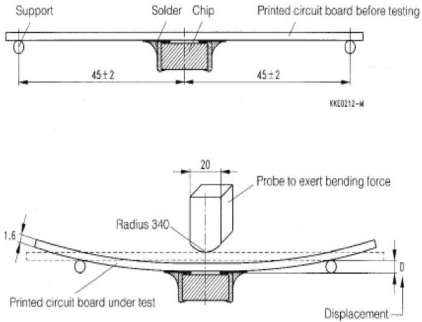
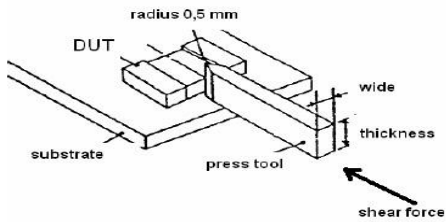
Item	Performance	Test Condition						
Vibration		Preconditioning: Run through IR reflow for 3 times.(IPC/JEDEC J-STD-020E Classification Reflow Profiles) Oscillation Frequency: 10Hz~2KHz~10Hz for 20 minute Equipment: Vibration checker Total Amplitude: 5g Testing Time : 12 hours(20 minutes, 12 cycles each of 3 orientations).						
Resistance to Soldering Heat	Appearance: No damage. Inductance: within ± 10% of initial value RDC: within ± 15% of initial value and shall not exceed the specification value	Test condition:(MIL-STD-202 Condition B) Number of heat cycles:1 <table border="1" data-bbox="963 409 1337 504"> <thead> <tr> <th>Temperature(°C)</th> <th>Time(s)</th> <th>Temperature ramp/immersion and emersion rate</th> </tr> </thead> <tbody> <tr> <td>260±5 (solder temp)</td> <td>10±1</td> <td>25mm/s±6mm/s</td> </tr> </tbody> </table> Depth: completely cover the termination	Temperature(°C)	Time(s)	Temperature ramp/immersion and emersion rate	260±5 (solder temp)	10±1	25mm/s±6mm/s
Temperature(°C)	Time(s)	Temperature ramp/immersion and emersion rate						
260±5 (solder temp)	10±1	25mm/s±6mm/s						
Thermal shock (AEC-Q200)		Preconditioning: Run through IR reflow for 3 times.(IPC/JEDEC J-STD-020E Classification Reflow Profiles) Condition for 1 cycle Step1: -55±2°C 15±1min(Inductor) Step2: 155±2°C within 20Sec. Step3: 155±2°C 15±1min Number of cycles: 300 Measured at room tempraturc after placing fo24±2hrs						
ESD	Appearance: No damage.	 <p>Direct Contact and Air Discharge PASSIVE COMPONENT HBM ESD Discharge Waveform to a Coaxial Target Test method: AEC-Q200-002 Test mode: Contact Discharge Discharge level: 4 KV (Level: 2)</p>						
Solderability	More than 95% of the terminal electrode should be covered with solder.	a. Method B1, 4 hrs @155°C dry heat @235°C±5°C Test time:5 +0/-0.5 seconds. b. Method D category 3. (steam aging 8hours ± 15 min)@ 260°C±5°C Test time: 30 +0/-0.5 seconds.						
Electrical Characterization	Refer Specification for Approval	Summary to show Min, Max, Mean and Standard deviation .						
Flammability	Electrical Test not required.	V-0 or V-1 are acceptable.						
Board Flex	Appearance: No damage	Preconditioning: Run through IR reflow for 3 times.(IPC/JEDEC J-STD-020E Classification Reflow Profiles) Place the 100mm X 40mm board into a fixture similar to the one shown in below Figure with the component facing down. The apparatus shall consist of mechanical means to apply a force which will bend the board (D) x = 2 mm minimum. The duration of the applied forces shall be 60 (+ 5) sec. The force is to be applied only once to the board. 						
Terminal Strength(SMD)	Appearance: No damage	Preconditioning: Run through IR reflow for 3 times.(IPC/JEDEC J-STD-020E Classification Reflow Profiles) With the component mounted on a PCB with the device to be tested, apply a 17.7 N (1.8 Kg) force to the side of a device being tested. This force shall be applied for 60 +1 seconds. Also the force shall be applied gradually as not to apply a shock to the component being tested. 						

Note : When there are questions concerning measurement result : measurement shall be made after 48 ± 2 hours of recovery under the standard condition.

9. Soldering Specifications

(1) Soldering

Mildly activated rosin fluxes are preferred. TAI-TECH terminations are suitable for re-flow soldering systems. If hand soldering cannot be avoided, the preferred technique is the utilization of hot air soldering tools.

(2) IR Soldering Reflow:

Recommended temperature profiles for lead free re-flow soldering in Figure 1. Table 1.1&1.2 (J-STD-020E)

(3) Iron Reflow:

Products attachment with a soldering iron is discouraged due to the inherent process control limitations. In the event that a soldering iron must be employed the following precautions are recommended.(Fig. 2)

- Preheat circuit and products to 150°C
- Never contact the ceramic with the iron tip
- Use a 20 watt soldering iron with tip diameter of 1.0mm
- 355°C tip temperature (max)
- 1.0mm tip diameter (max)
- Limit soldering time to 4~5sec.

Fig.1 IR Soldering Reflow

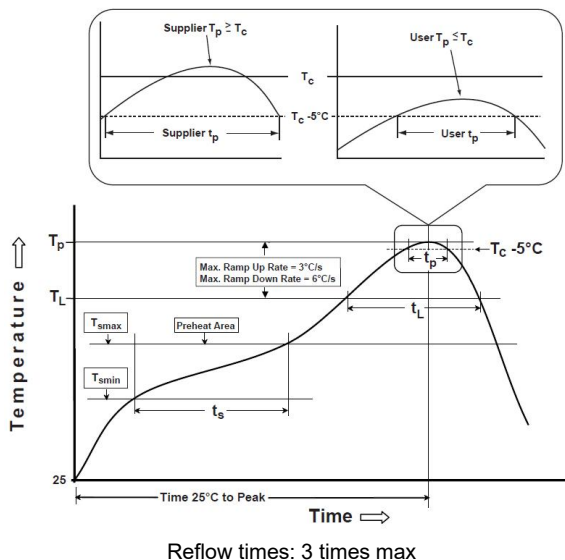

Fig.2 Iron soldering temperature profiles

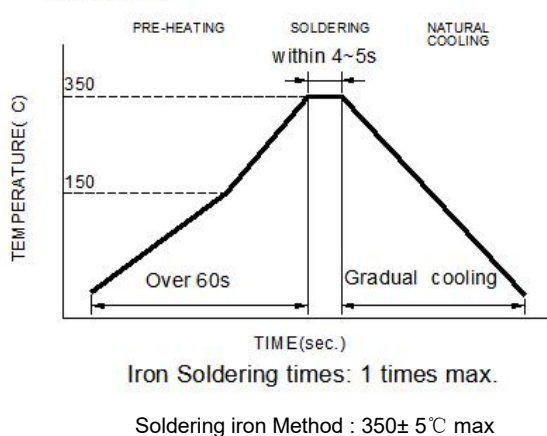

Table (1.1): Reflow Profiles

Profile Type:	Pb-Free Assembly
Preheat	
-Temperature Min(T_{smin})	150°C
-Temperature Max(T_{smax})	200°C
-Time(t_s)from(T_{smin} to T_{smax})	60-120seconds
Ramp-up rate(T_L to T_p)	3°C/second max.
Liquidus temperature(T_L)	217°C
Time(t_L)maintained above T_L	60-150 seconds
Classification temperature(T_c)	See Table (1.2)
Time(t_p) at $T_c - 5^\circ C$ (T_p should be equal to or less than T_c .)	* < 30 seconds
Ramp-down rate(T_p to T_L)	6°C /second max.
Time 25°C to peak temperature	8 minutes max.

T_p : maximum peak package body temperature, T_c : the classification temperature.

For user (customer) T_p should be equal to or less than T_c .

* Tolerance for peak profile temperature (T_p) is defined as a supplier minimum and a user maximum.

Table (1.2) Package Thickness/Volume and Classification Temperature (T_c)

	Package Thickness	Volume mm ³ <350	Volume mm ³ 350-2000	Volume mm ³ >2000
PB-Free Assembly	<1.6mm	260°C	260°C	260°C
	1.6-2.5mm	260°C	250°C	245°C
	≥2.5mm	250°C	245°C	245°C

Reflow is referred to standard IPC/JEDEC J-STD-020E.

10. Notes

- (1) When there are questions concerning measurement result : measurement shall be made after 48 ± 2 hours of recovery under the standard condition
- (2) This power choke coil itself does not have any protective function in abnormal condition such as overload, short-circuit and open-circuit conditions, etc. Therefore, it shall be confirmed as the end product that there is no risk of smoking, fire, dielectric withstand voltage, insulation resistance, etc. in abnormal conditions to provide protective devices and/or protection circuit in the end product.
- (3) When this power choke coil was used in a similar or new product to the original one, sometimes it might not be able to satisfy the specifications due to different condition of use.
- (4) Dielectric withstanding test with higher voltage than specific value will damage insulating material and shorten its life.
- (5) This power choke coil must not be used in wet condition by water, coffee or any liquid because insulation strength becomes very low in this condition.
- (6) Please consult our company to confirm the reliability of the process required to wash or use or exposure to a chemical solvent used in this product. PCB washing tested to MIL-STD-202 Method, and dry it off immediately.
- (7) The rated current as listed is either the saturation current or the heating current depending on which value is lower.
- (8) If this power choke is dipped in the cleaning agent, such as toluene, xylene, ketone, and ether system, there is a possibility that the performance decreases greatly, and marking disappears.
- (9) The high power ultrasonic washing may damage the choke body.
- (10) Before use, the user should determine whether this product is suitable for their own design, Our company only guarantees that the product meets the requirements of this specification.

Application Notice

- Storage Conditions
 - To maintain the solderability of terminal electrodes:
 1. TAI-TECH products meet IPC/JEDEC J-STD-020E standard-MSL, level 1.
 2. Temperature and humidity conditions: Less than 40°C and 60% RH.
 3. Recommended products should be used within 12 months form the time of delivery.
 4. The packaging material should be kept where no chlorine or sulfur exists in the air.
- Transportation
 - 1. Products should be handled with care to avoid damage or contamination from perspiration and skin oils.
 - 2. The use of tweezers or vacuum pick up is strongly recommended for individual components.
 - 3. Bulk handling should ensure that abrasion and mechanical shock are minimized.

11. Typical Performance Curves

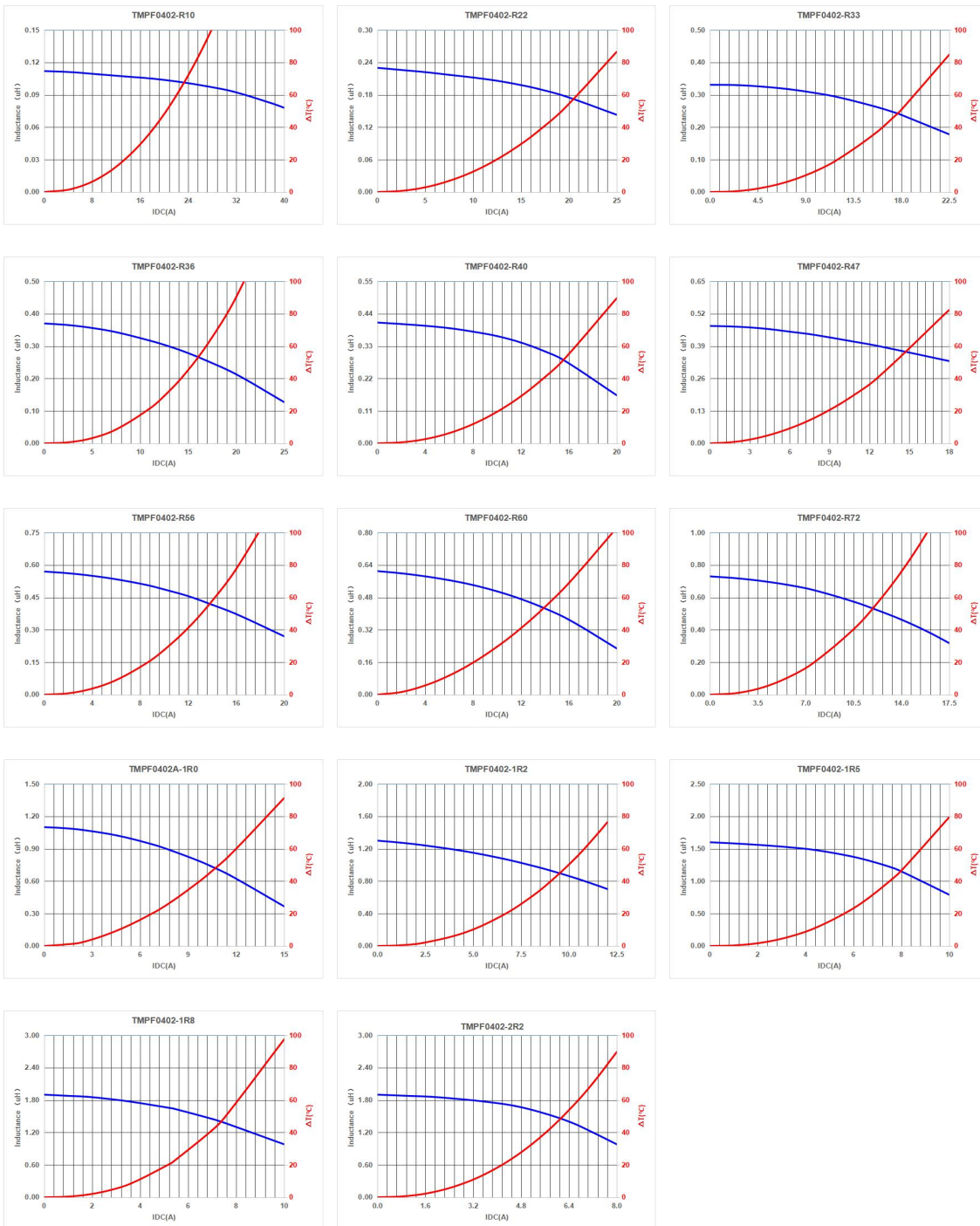

单击下面可查看定价，库存，交付和生命周期等信息

[>>TAI-TECH\(台庆\)](#)