

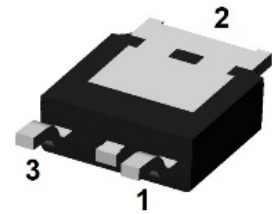
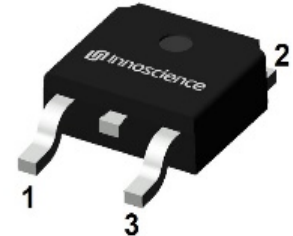
# INN700TK350B

## 1. General description

700V GaN-on-Silicon Enhancement-mode Power Transistor in TO-252 package.

## 2. Features

- Enhancement mode transistor-Normally off power switch
- Ultra high switching frequency
- No reverse-recovery charge
- Low gate charge, low output charge
- Qualified for industrial applications according to JEDEC Standards
- ESD safeguard
- RoHS, Pb-free, REACH-compliant



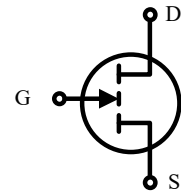
## 3. Applications

- DCM/BCM PFC
- AHB/LLC/QR Flyback/ACF DCDC converter
- LED driver
- Fast battery charger
- Notebook/AIO adaptor
- Desktop PC/ATX/TV/power tool power supply

## 4. Key performance parameters

**Table 1** Key performance parameters at  $T_j = 25\text{ }^\circ\text{C}$

Parameter	Value	Unit
$V_{DS,max}$	700	V
$R_{DS(on),max} @ V_{GS} = 6\text{ V}$	350	m $\Omega$
$Q_{G,typ} @ V_{DS} = 400\text{ V}$	1.5	nC
$I_{D,pulse}$	10	A
$Q_{OSS} @ V_{DS} = 400\text{ V}$	13	nC
$Q_{rr} @ V_{DS} = 400\text{ V}$	0	nC



## 5. Pin information

**Table 2** Pin information

Gate	Source	Drain
1	2	3

**Table 3** Ordering information

Type/Ordering Code	Package	Product Code
INN700TK350B	TO-252	70TK350B

**Table of contents**

<b>1. General description .....</b>	<b>1</b>
<b>2. Features .....</b>	<b>1</b>
<b>3. Applications.....</b>	<b>1</b>
<b>4. Key performance parameters.....</b>	<b>1</b>
<b>5. Pin information .....</b>	<b>1</b>
<b>6. Maximum ratings.....</b>	<b>3</b>
<b>7. Thermal characteristics.....</b>	<b>4</b>
<b>8. Electric characteristics .....</b>	<b>5</b>
<b>9. Electric characteristics diagrams .....</b>	<b>7</b>
<b>10.Package outlines .....</b>	<b>13</b>
<b>11.Reel information.....</b>	<b>14</b>
<b>12.Recommended PCB footprint .....</b>	<b>15</b>
<b>13.Revision history .....</b>	<b>16</b>

## 6. Maximum ratings

at  $T_j = 25\text{ °C}$  unless otherwise specified.

Continuous application of maximum ratings can deteriorate transistor lifetime. For further information, contact Innoscence sales office.

**Table 4** Maximum ratings

Parameter	Symbol	Values	Unit	Note/Test Condition
Drain source voltage	$V_{DS,max}$	700	V	$V_{GS} = 0\text{ V}$ , $T_j = -55\text{ °C}$ to $150\text{ °C}$
Drain source voltage transient <sup>1</sup>	$V_{DS,transient}$	800	V	$V_{GS} = 0\text{ V}$
Drain source voltage, pulsed <sup>2</sup>	$V_{DS,pulse}$	750	V	$T_j = 25\text{ °C}$ ; total time < 10 h $T_j = 125\text{ °C}$ ; total time < 1 h
Continuous current, drain source	$I_D$	6	A	$T_c = 25\text{ °C}$
Pulsed current, drain source <sup>3</sup>	$I_{D,pulse}$	10	A	$T_c = 25\text{ °C}$ ; $V_{GS} = 6\text{ V}$ ; $t_{PULSE} = 10\text{ }\mu\text{s}$
Pulsed current, drain source <sup>3</sup>	$I_{D,pulse}$	6	A	$T_c = 125\text{ °C}$ ; $V_{GS} = 6\text{ V}$ ; $t_{PULSE} = 10\text{ }\mu\text{s}$
Gate source voltage, continuous <sup>4</sup>	$V_{GS}$	-1.4 to +7	V	$T_j = -55\text{ °C}$ to $150\text{ °C}$
Gate source voltage, pulsed	$V_{GS,pulse}$	-20 to +10	V	$T_j = -55\text{ °C}$ to $150\text{ °C}$ ; $t_{PULSE} = 50\text{ ns}$ , $f = 100\text{ kHz}$ ; open drain
Power dissipation	$P_{tot}$	47	W	$T_c = 25\text{ °C}$
Operating temperature	$T_j$	-55 to +150	°C	
Storage temperature	$T_{stg}$	-55 to +150	°C	

- 1  $V_{DS,transient}$  is intended for non-repetitive events,  $t_{PULSE} < 200\text{ }\mu\text{s}$
- 2  $V_{DS,pulse}$  is intended for repetitive pulse,  $t_{PULSE} < 100\text{ ns}$
- 3 Limit was extracted from characterization test, not measured during production
- 4 The minimum  $V_{GS}$  is clamped by ESD protection circuit, as shown in Figure 10

## 7. Thermal characteristics

Table 5 Thermal characteristics

Parameter	Symbol	Values	Unit	Note/Test Condition
Thermal resistance, junction-ambient	$R_{thJA}$	56	°C/W	
Thermal resistance, junction-case	$R_{thJC}$	2.63	°C/W	
Maximum reflow soldering temperature	$T_{sold}$	260	°C	MSL3

1.  $R_{thJA}$  is determined with the device mounted on one square inch of copper pad, single layer 2oz copper on FR4 board.

## 8. Electric characteristics

at  $T_j = 25\text{ °C}$ , unless specified otherwise

**Table 6 Static characteristics**

Parameter	Symbol	Values			Unit	Note/Test Condition
		Min.	Typ.	Max.		
Gate threshold voltage	$V_{GS(th)}$	1.2	1.7	2.5	V	$I_D = 6.6\text{ mA}$ ; $V_{DS} = V_{GS}$ ; $T_j = 25\text{ °C}$
		-	1.7	-		$I_D = 6.6\text{ mA}$ ; $V_{DS} = V_{GS}$ ; $T_j = 125\text{ °C}$
Drain-source leakage current	$I_{DSS}$	-	0.6	12	$\mu\text{A}$	$V_{DS} = 700\text{ V}$ ; $V_{GS} = 0\text{ V}$ ; $T_j = 25\text{ °C}$
		-	5	-		$V_{DS} = 700\text{ V}$ ; $V_{GS} = 0\text{ V}$ ; $T_j = 150\text{ °C}$
Gate-source leakage current	$I_{GSS}$	-	30	-	$\mu\text{A}$	$V_{GS} = 6\text{ V}$ ; $V_{DS} = 0\text{ V}$
Drain-source on-state resistance	$R_{DS(on)}$	-	270	350	m $\Omega$	$V_{GS} = 6\text{ V}$ ; $I_D = 2.2\text{ A}$ ; $T_j = 25\text{ °C}$
		-	580	-		$V_{GS} = 6\text{ V}$ ; $I_D = 2.2\text{ A}$ ; $T_j = 150\text{ °C}$
Gate resistance	$R_G$	-	11	-	$\Omega$	$f = 5\text{ MHz}$ ; open drain

**Table 7 Dynamic characteristics**

Parameter	Symbol	Values			Unit	Note/Test Condition
		Min.	Typ.	Max.		
Input capacitance	$C_{iss}$	-	50	-	pF	$V_{GS} = 0\text{ V}$ ; $V_{DS} = 400\text{ V}$ ; $f = 100\text{ kHz}$
Output capacitance	$C_{oss}$	-	15	-	pF	$V_{GS} = 0\text{ V}$ ; $V_{DS} = 400\text{ V}$ ; $f = 100\text{ kHz}$
Reverse transfer Capacitance	$C_{rss}$	-	0.2	-	pF	$V_{GS} = 0\text{ V}$ ; $V_{DS} = 400\text{ V}$ ; $f = 100\text{ kHz}$
Effective output capacitance, energy related <sup>1</sup>	$C_{o(er)}$	-	20	-	pF	$V_{GS} = 0\text{ V}$ ; $V_{DS} = 0\text{ to }400\text{ V}$
Effective output capacitance, time related <sup>2</sup>	$C_{o(tr)}$	-	28	-	pF	$V_{GS} = 0\text{ V}$ ; $V_{DS} = 0\text{ to }400\text{ V}$
Output charge	$Q_{oss}$	-	13	-	nC	$V_{GS} = 0\text{ V}$ ; $V_{DS} = 0\text{ to }400\text{ V}$
Turn-on delay time	$t_{d(on)}$	-	0.9	-	ns	$V_{DS} = 400\text{ V}$ ; $I_D = 4.4\text{ A}$ ; $L = 318\text{ }\mu\text{H}$ ; $V_{GS} = 6\text{ V}$ ; $R_{on} = 10\text{ }\Omega$ ; $R_{off} = 2\text{ }\Omega$ ; See Figure 22
Turn-off delay time	$t_{d(off)}$	-	1.2	-	ns	
Rise time	$t_r$	-	3.5	-	ns	
Fall time	$t_f$	-	6.1	-	ns	

- $C_{o(er)}$  is the fixed capacitance that gives the same stored energy as  $C_{oss}$  while  $V_{DS}$  is rising from 0 to 400 V
- $C_{o(tr)}$  is the fixed capacitance that gives the same charging time as  $C_{oss}$  while  $V_{DS}$  is rising from 0 to 400 V

**Table 8 Gate charge characteristics**

Parameter	Symbol	Values			Unit	Note/Test Condition
		Min.	Typ.	Max.		
Gate charge	$Q_G$	-	1.5	-	nC	$V_{GS} = 0$ to 6 V; $V_{DS} = 400$ V; $I_D = 2.2$ A
Gate-source charge	$Q_{GS}$	-	0.15	-	nC	
Gate-drain charge	$Q_{GD}$	-	0.5	-	nC	
Gate Plateau Voltage	$V_{Plat}$	-	2.2	-	V	$V_{DS} = 400$ V; $I_D = 2.2$ A

**Table 9 Reverse conduction characteristics**

Parameter	Symbol	Values			Unit	Note/Test Condition
		Min.	Typ.	Max.		
Source-Drain reverse voltage	$V_{SD}$	-	2.6	-	V	$V_{GS} = 0$ V; $I_S = 2.2$ A
Pulsed current, reverse	$I_{S,pulse}$	-	-	10	A	$V_{GS} = 6$ V; $t_{PULSE} = 10$ $\mu$ s
Reverse recovery charge	$Q_{rr}$	-	0	-	nC	$I_S = 2.2$ A; $V_{DS} = 400$ V
Reverse recovery time	$t_{rr}$	-	0	-	ns	
Peak reverse recovery current	$I_{rrm}$	-	0	-	A	

## 9. Electric characteristics diagrams

at  $T_j = 25\text{ }^\circ\text{C}$ , unless specified otherwise

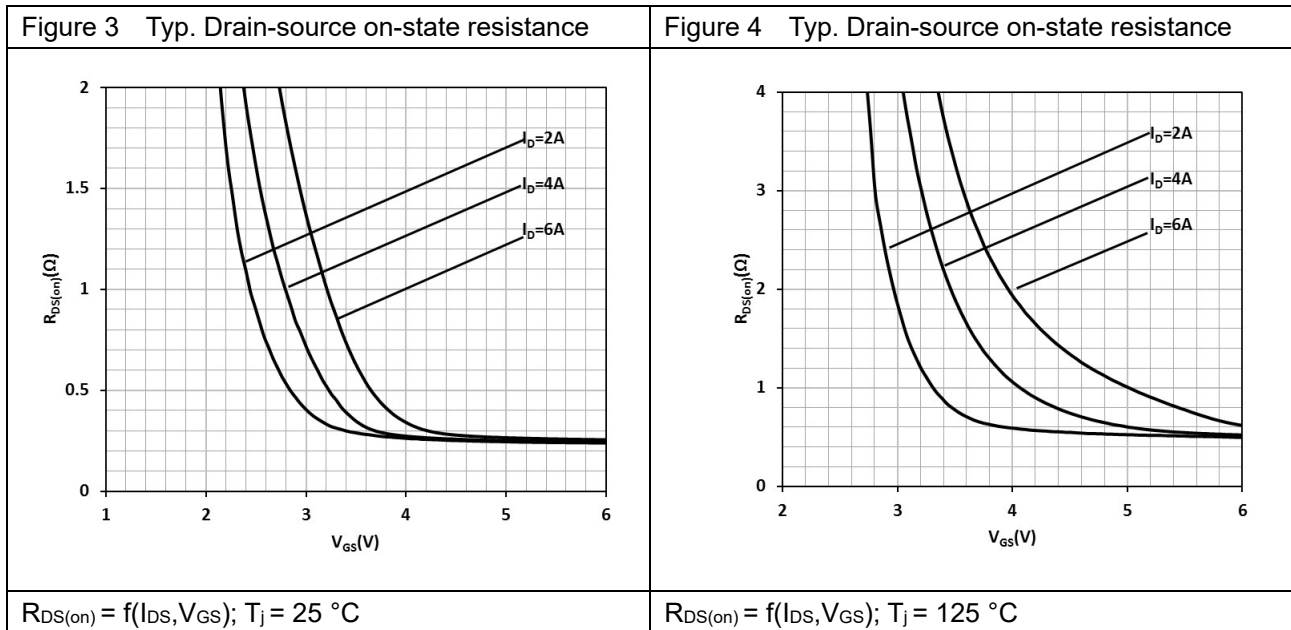
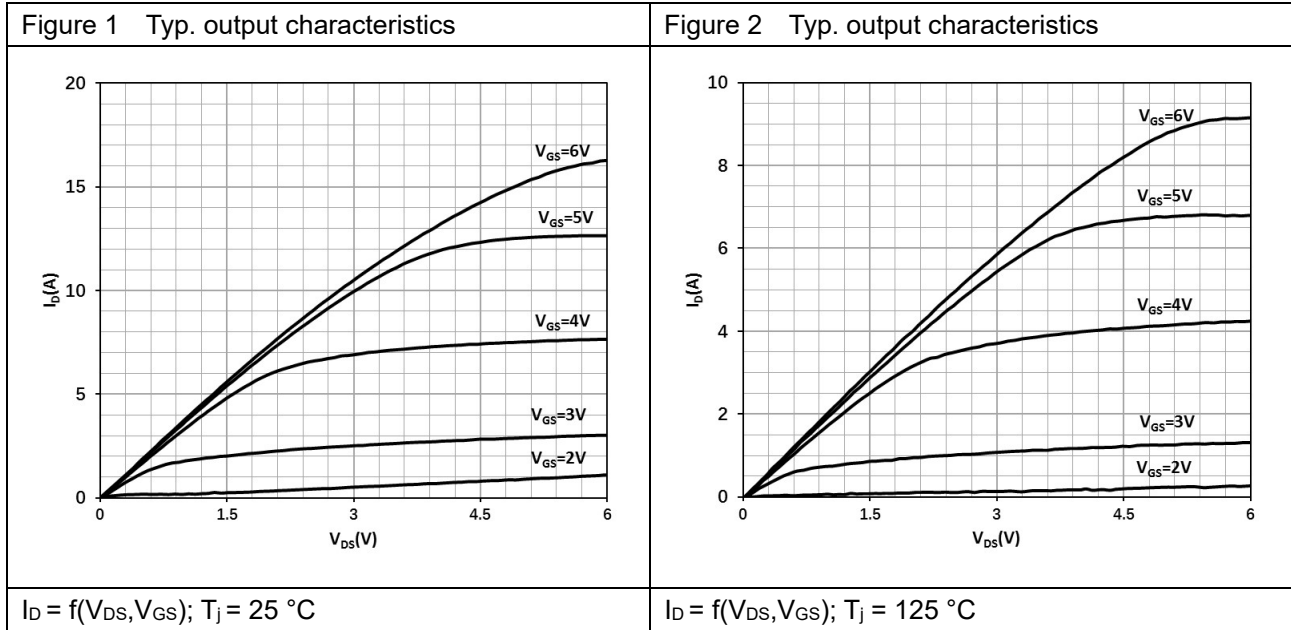
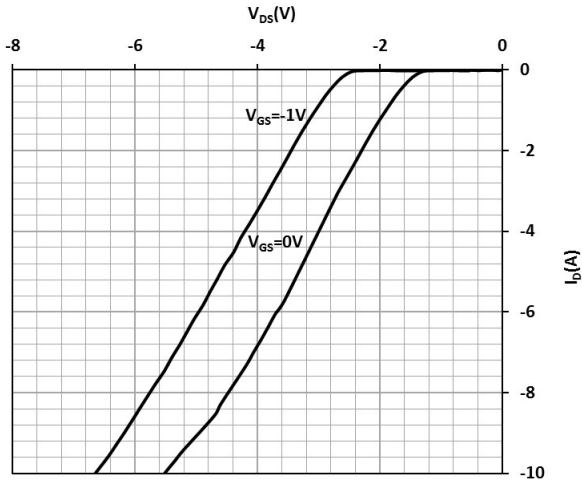
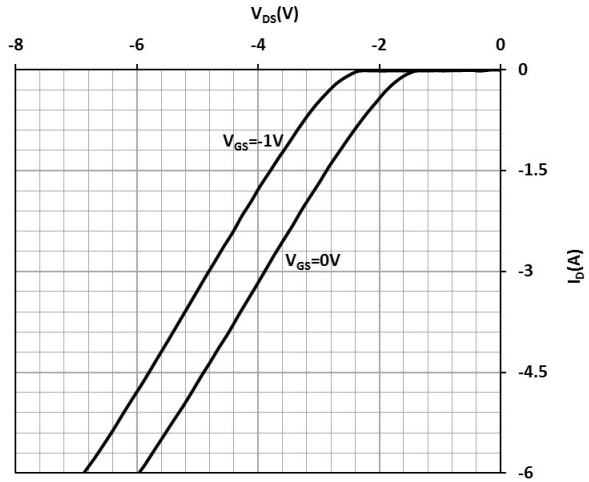


Figure 5 Typ. channel reverse characteristics



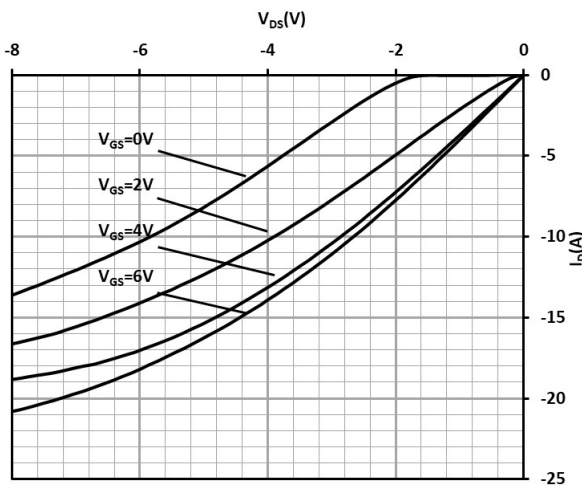
$I_D = f(V_{DS}, V_{GS}); T_j = 25\text{ }^\circ\text{C}$

Figure 6 Typ. channel reverse characteristics



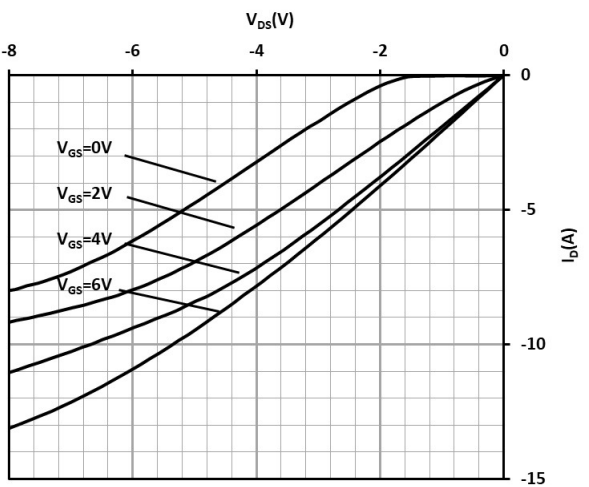
$I_D = f(V_{DS}, V_{GS}); T_j = 125\text{ }^\circ\text{C}$

Figure 7 Typ. channel reverse characteristics



$I_D = f(V_{DS}, V_{GS}); T_j = 25\text{ }^\circ\text{C}$

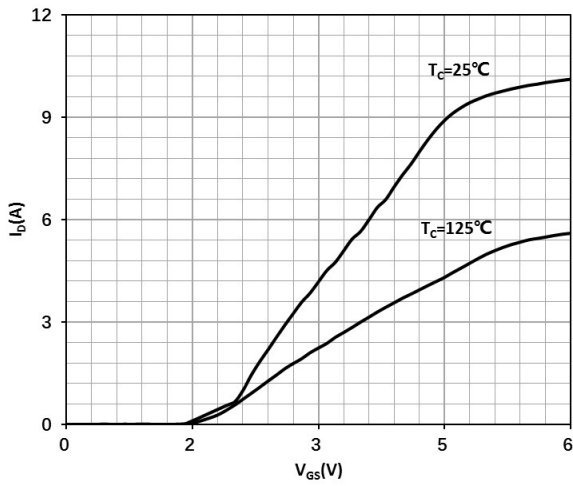
Figure 8 Typ. channel reverse characteristics



$I_D = f(V_{DS}, V_{GS}); T_j = 125\text{ }^\circ\text{C}$

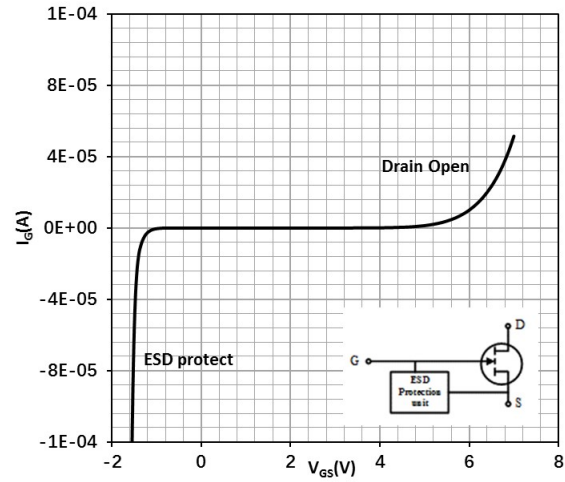


Figure 9 Typ. transfer characteristics



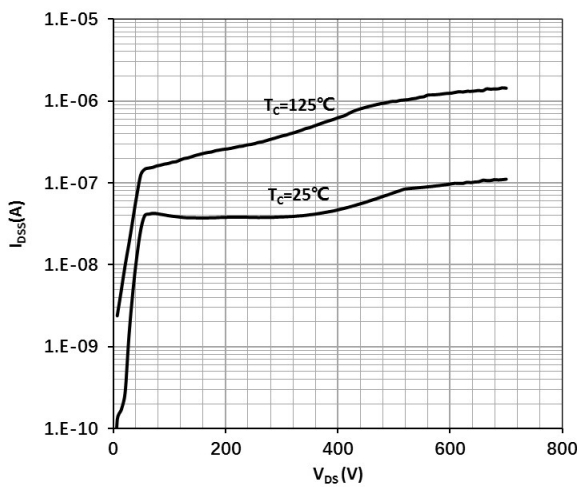
$I_D = f(V_{GS}); V_{DS} = 3\text{ V}$

Figure 10 Typ. Gate-to-Source leakage



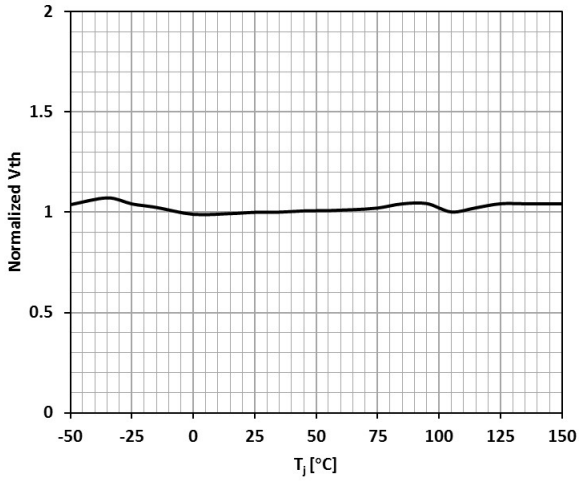
$I_G = f(V_{GS}); I_G$  reverse turn on by ESD unit

Figure 11 Drain-source leakage characteristics



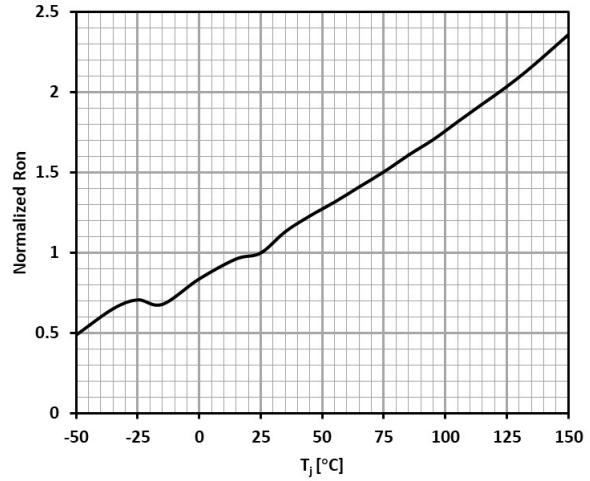
$I_{DSS} = f(V_{DS}); V_{GS} = 0\text{ V}$

Figure 12 Gate threshold voltage



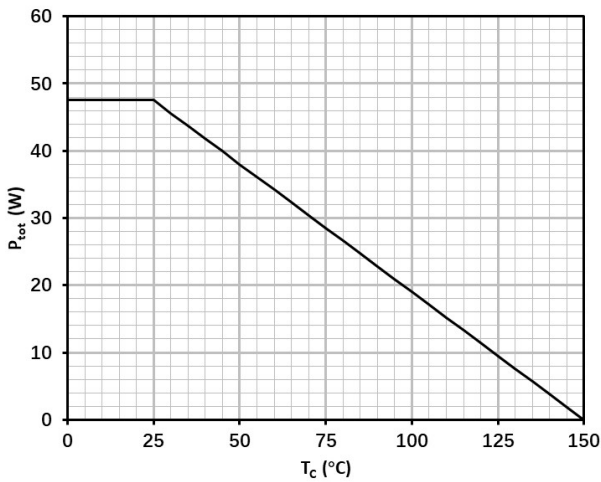
$V_{TH} = f(T_j); V_{GS} = V_{DS}; I_D = 6.6 \text{ mA}$

Figure 13 Drain-source on-state resistance



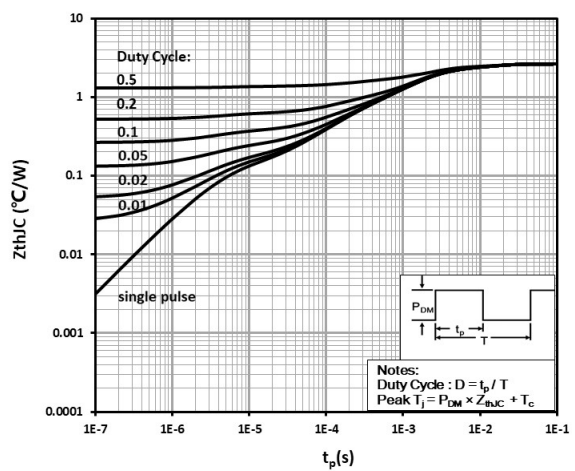
$R_{DS(on)} = f(T_j); I_D = 2.2 \text{ A}; V_{GS} = 6V$

Figure 14 Power dissipation



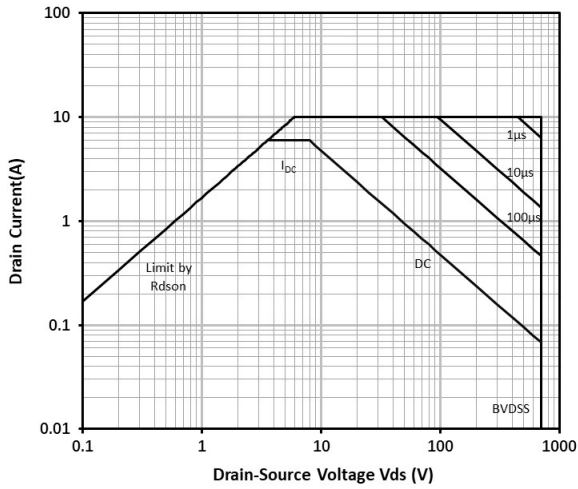
$P_{tot} = f(T_c)$

Figure 15 Max.transient thermal impedance



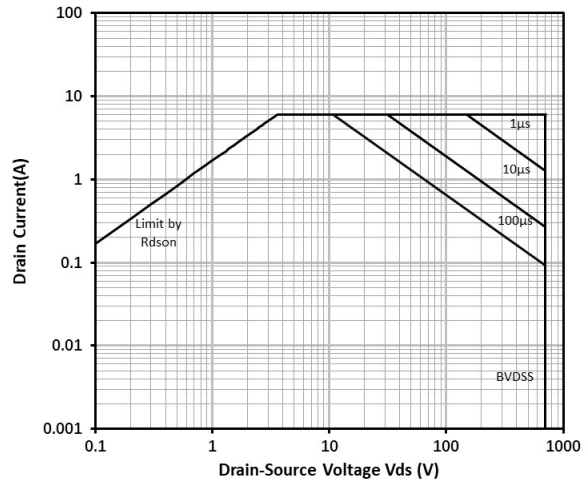
$Z_{thJC} = f(t_p, D)$

Figure 16 Safe operating area



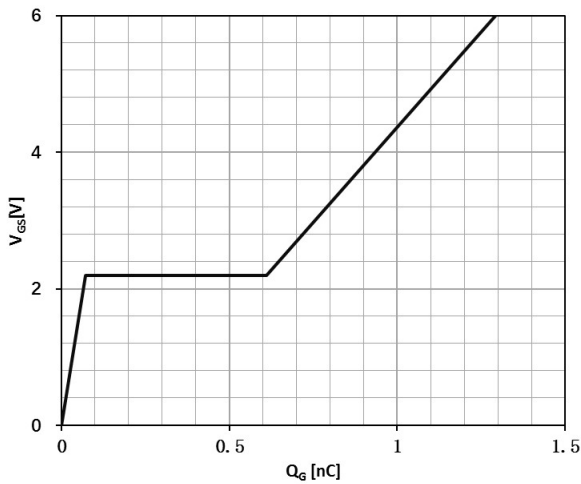
$I_D = f(V_{DS}); T_C = 25\text{ }^\circ\text{C}$

Figure 17 Safe operating area



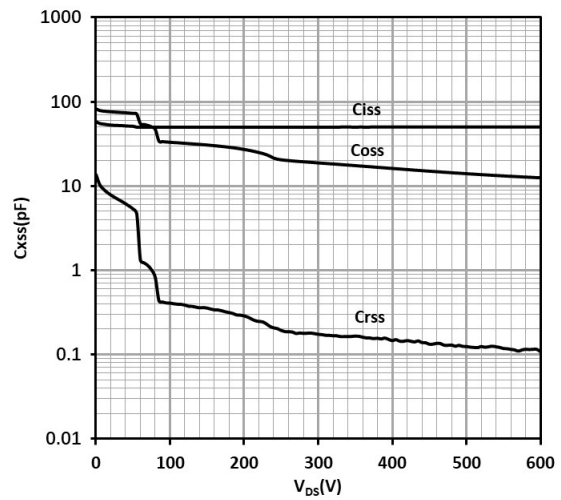
$I_D = f(V_{DS}); T_C = 125\text{ }^\circ\text{C}$

Figure 18 Typ. gate charge



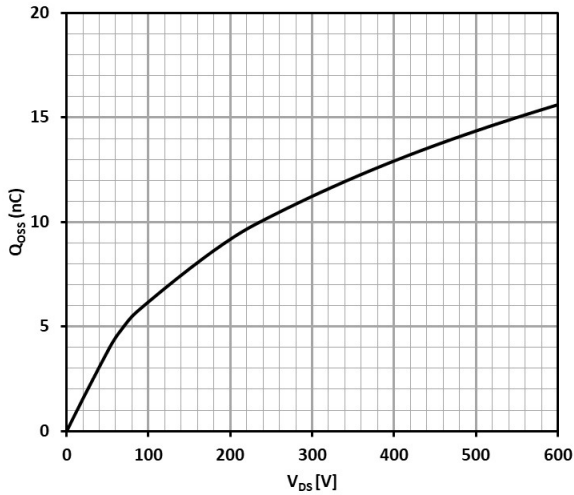
$V_{GS} = f(Q_G); V_{DCLINK} = 400\text{ V}; I_D = 2.2\text{ A}$

Figure 19 Typ. capacitances



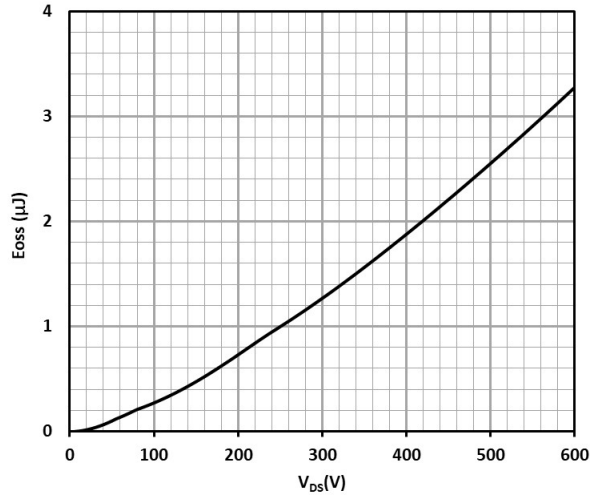
$C_{XSS} = f(V_{DS}); \text{Freq.} = 100\text{ kHz}$

Figure 20 Typ. output charge



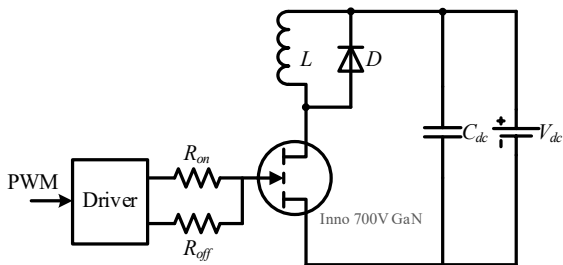
$Q_{oss} = f(V_{DS}); \text{Freq.} = 100 \text{ kHz}$

Figure 21 Typ. Coss stored Energy



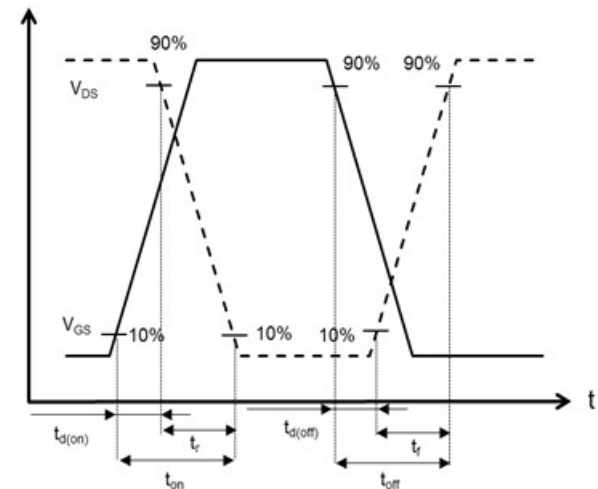
$E_{oss} = f(V_{DS}); \text{Freq.} = 100 \text{ kHz}$

Figure 22 Typ. Switching times with inductive load

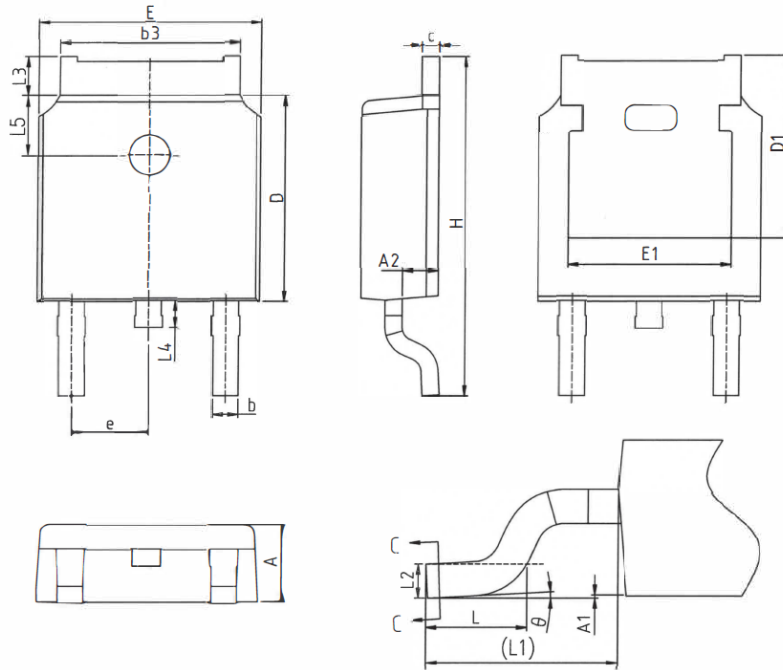


$V_{DS} = 400 \text{ V}, I_D = 4.4 \text{ A}, L = 318 \mu\text{H}, V_{GS} = 6 \text{ V},$   
 $R_{on} = 10 \Omega, R_{off} = 2 \Omega$

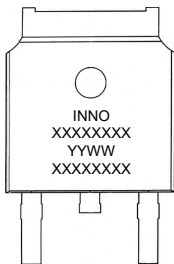
Figure 23 Typ. Switching times waveform



**10. Package outlines**



SYMBOL	MM			SYMBOL	MM		
	MIN	NOM	MAX		MIN	NOM	MAX
A	2.20	2.30	2.40	e	2.286BSC		
A1	0.00	-	0.13	H	9.40	10.10	10.50
A2	0.92	1.07	1.17	L	1.38	1.50	1.75
b	0.63	0.78	0.90	L1	2.90REF		
b3	5.10	5.33	5.46	L2	0.51BSC		
c	0.43	0.53	0.61	L3	0.88	-	1.28
D	5.98	6.10	6.22	L4	0.50	-	1.00
D1	5.30REF			L5	1.65	1.80	1.95
E	6.40	6.60	6.73	θ	0°	-	8°
E1	4.83REF						



ROW	Description	Example
Row1	Company name	INNO
Row2	Product code	XXXXXXXX
Row3	Date code	YYWW
Row4	ASSY lot No.	XXXXXXXX

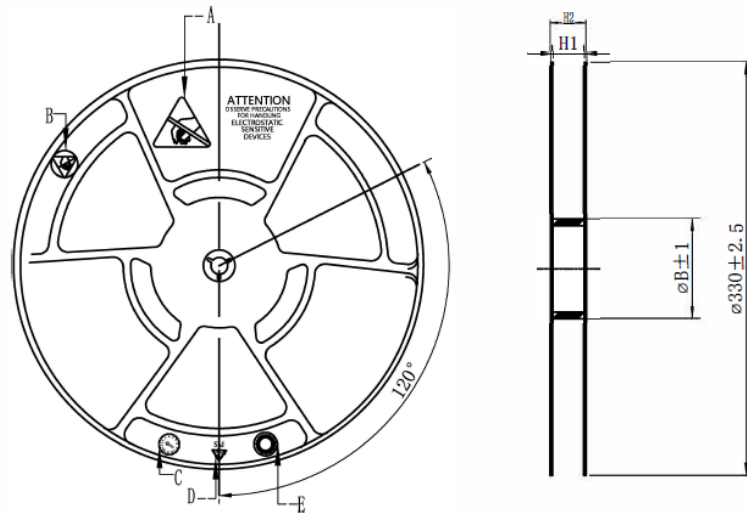
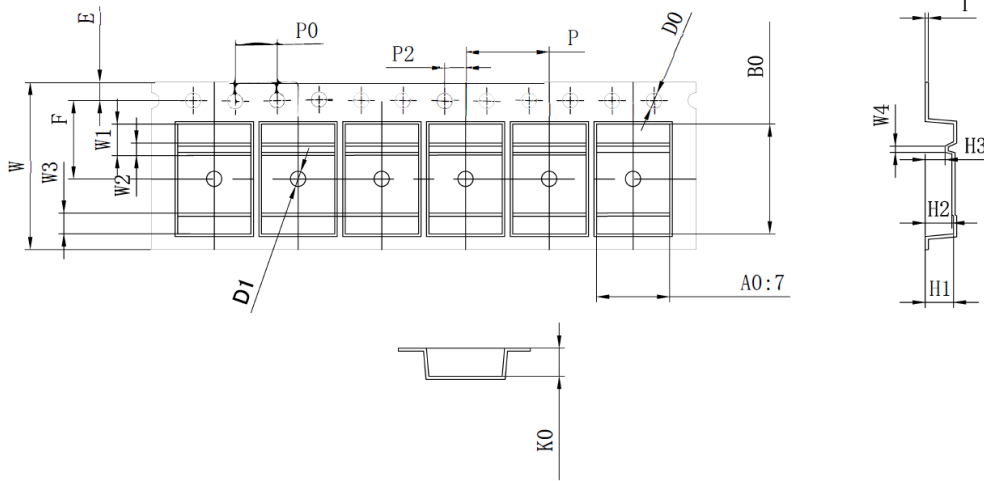
**Notes:**

- (1) All dimension are in millimeters.
- (2) Drawing is not to scale.
- (3) Dimensions do not include mold protrusion.
- (4) Package outline exclusive of metal burr dimensions.

### 11. Reel information

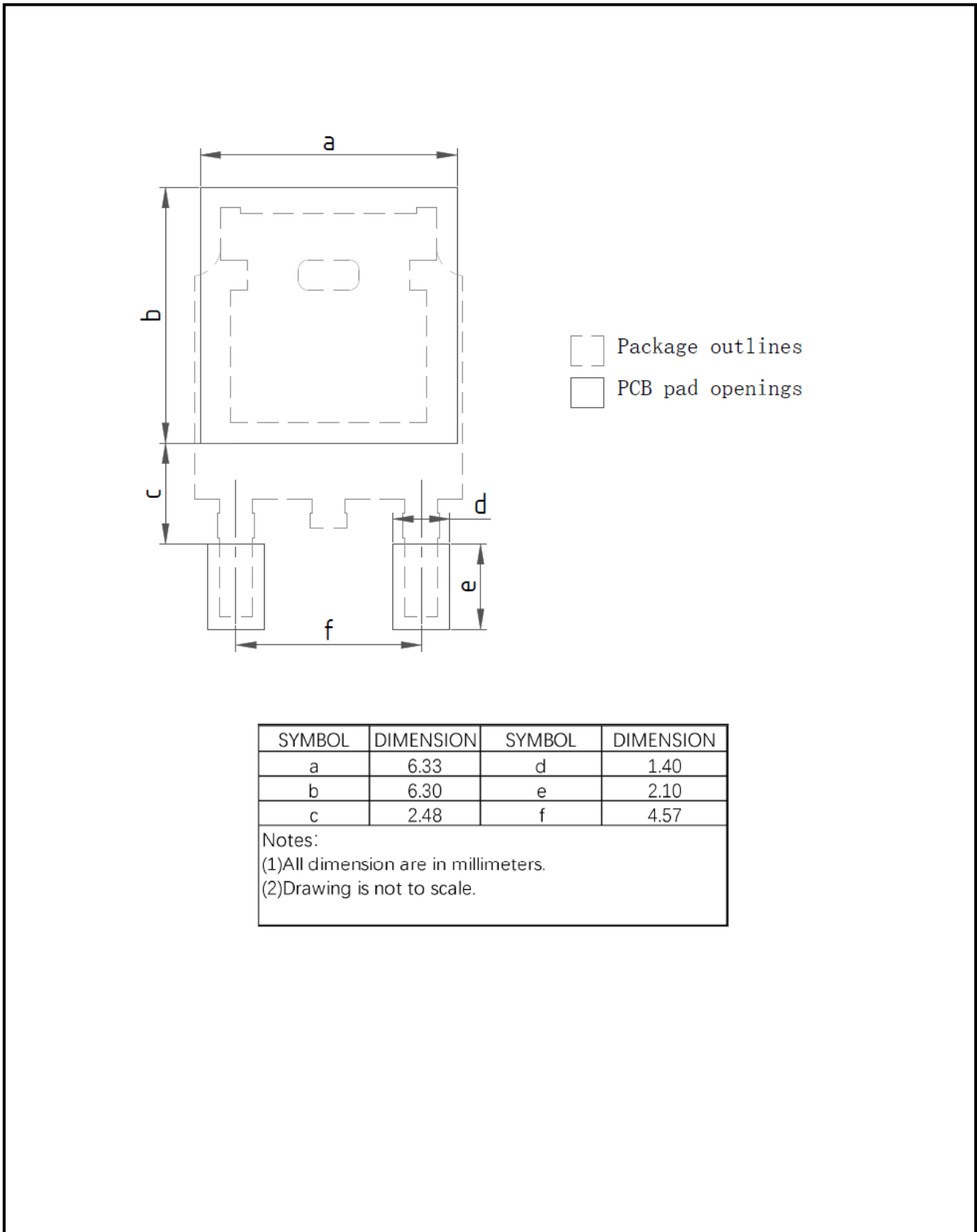
D	16.0	0.30	8.00	7.00	10.50	2.70	0.00	1.75	7.50	4.00	2.00	1.55	1.50	3.0	1.2	2.0	2.7	2.5	1.7	0.6
A	+0.40	+0.08	+0.15	+0.20	+0.15	+0.15	+0.00	+0.15	+0.15	+0.15	+0.15	+0.15	+0.25	+0.15	+0.15	+0.15	+0.15	+0.15	+0.15	+0.15
T	-0.20	-0.08	-0.15	-0.20	-0.15	-0.15	-0.10	-0.15	-0.15	-0.15	-0.15	-0.15	-0.25	-0.15	-0.15	-0.15	-0.15	-0.15	-0.15	-0.15
A	W	T	P	A0	B0	K0	K1	E	F	P0	P2	D0	D1	W1	W2	W3	H1	H2	H3	W4

Unit:mm



Unit:	mm
Tape Width	16
H1	16.4±0.1
H2MAX	22.4

**12. Recommended PCB footprint**



### 13. Revision history

**Major changes since the last revision**

Revision	Date	Description of changes
1.0	2023-04-21	1.0 version release
1.1	2023-12-26	Add Reel information.



---

## Important Notice

The information provided in this document is intended as a guide only and shall not in any event be regarded as a guarantee of conditions, characteristics or performance. Innoscience does not assume any liability arising out of the application or use of any product described herein, including but not limited to any personal injury, death, or property or environmental damage. No licenses, patent rights, or any other intellectual property rights is granted or conveyed. Innoscience reserves the right to modify without notice. All rights reserved.

单击下面可查看定价，库存，交付和生命周期等信息

[>>Innoscence\(英诺赛科\)](#)