

# <SPECIFICATION>

SPEC.No. ASDIQ-SPE-194(00)

Date: Nov.30,2022

To :

CUSTOMER'S PRODUCT NAME

ASDI PRODUCT NAME:

ASUW-SERIES

## RECEIPT CONFIRMATION

UNCONDITIONAL CONSENT

CONDITIONAL CONSENT

APPROVED

CHECKED

## ASDI SIGNATURE

APPROVED

CHECKED

PREPARED

Xianglong Li

Liang Wang

Jiayin Cai



Xiamen ASDI Electronics Co.,Ltd.



## CAUTION WHEN HANDLING

Before use the products, please read this specification.

## CAUTION FOR SAFETY USING

When use the products, be careful to mentioned below for safety using.

## CAUTION

\*The product should be used within 12 monthes.

Focus on the storage conditions.

Solderability may become weak if it exceeds the period.

\*Do not use and store the product in condition of gas corrosion (Salt,Acid,Alkaline).

\*The products must be preheated before soldering.

\*Rework by soldering iron;Please keep the mentioned conditions in this specification.

\*In case of insert P.C. Board on chassis, do not add mechanical stress to the product.

\*Be careful to arrange of non-magnetic field type inductors.

The error may be caused by magnetic field coupling.

\*In case handle the products, please use wrist strap for ground static discharge on human body.

The product keeps away from magnet or magnetized things.

\*Do not use the product beyond the mentioned conditions in this specification.

\*About an application

The products listed on this specification sheet are intended for use in general electronic equipment (AV equipment, telecommunications equipment, home appliances, amusement equipment, computer equipment, personal equipment, office equipment, measurement equipment, industrial robots) under a normal operation and use condition.

\*The products are not designed or warranted to meet the requirements of the applications listed below, whose performance and/or quality require a more stringent level of safety or reliability, or whose failure, malfunction or trouble could cause serious damage to society, person or property. Please understand that we are not responsible for any damage or liability caused by use of the products in any of the applications below or for any other use exceeding the range or conditions set forth in this specification sheet.

- |                                |   |
|--------------------------------|---|
| 1)Aerospace/Aviation equipment | 6)Transportation control equipment      |
| 2)Military equipment           | 7)Power-generation control equipment    |
| 3)Seabed equipment             | which directly endanger human life      |
| 4)Safety equipment             | 8)Atomic energy-related equipment       |
| 5)Medical equipment            | 9)Other applications that are not       |
|                                | considered general-purpose applications |

If you intend to use the products in the following applications, please contact our sales office.

Transportation equipment (cars, electric trains, ships, etc.), Public information-processing equipment,

Electric heating apparatus / burning equipment, Disaster prevention/crime prevention equipment

When using this product in general-purpose applications, you are kindly requested to take into consideration securing protection circuit/equipment or providing backup circuits, etc., to ensure higher safety.

CUSTOMER

ASDI PART No.  
ASUW-SERIES

CUSTOMER'S DWG NO.

## 1.INDEX

Listed item	Attachment&Tables	Page
1.Dimension & Inner-configuration	Please see (1)	3/19
2.Product Spec. Model	Please see (2)	3/19
3.Electrical Characteristics List	Please see (3)	3/19
4.Reliability Testing Items	Please see (4)	15/19
5.Packaging	Please see (5)	16/19
6.Recommend Soldering Conditions	Please see (6)	17/19
7.Cleaning	Please see (7)	18/19
8.Storage Requirements	Please see (8)	18/19
9.Usage Of ODS	Please see (9)	19/19
10.Note	Please see (10)	19/19

## 2.Manufacturing Location

China

DWG.No.

ASDIQ-SPE-194(00)

PAGE  
2/19

Xiamen ASDI Electronics Co.,Ltd.

(1)Dimension & Inner-configuration

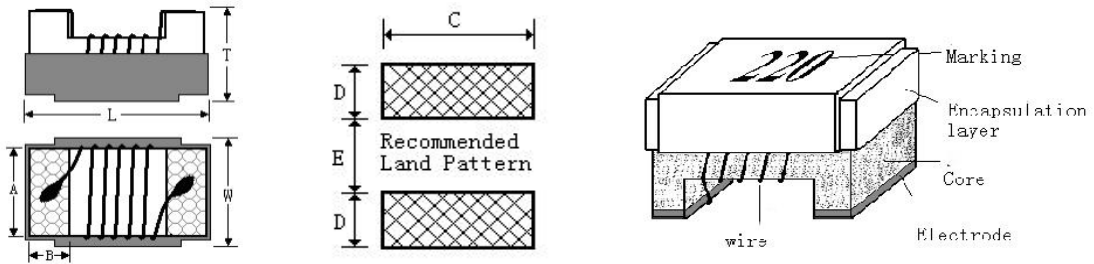

No.	Component	Material								
1	Core	Ceramic Core: $Al_2O_3$ Ferrite Core: Ni-Zn ferrite								
2	Electrode	<table border="1"> <thead> <tr> <th>Type</th> <th>Layout 0</th> <th>Layout 1</th> <th>Layout 2</th> </tr> </thead> <tbody> <tr> <td>Ferrite core</td> <td>Ag</td> <td>Ni</td> <td>Sn</td> </tr> </tbody> </table>	Type	Layout 0	Layout 1	Layout 2	Ferrite core	Ag	Ni	Sn
Type	Layout 0	Layout 1	Layout 2							
Ferrite core	Ag	Ni	Sn							
3	Wire	Cu								
4	Encapsulation layer	Epoxy								
5	Marking	Epoxy								

Unit: mm(inch)

Size	L (Max)	W (Max)	T (Max)	A	B	C	D	E
1005(0402)	1.19(0.047)	0.66(0.026)	0.60(0.024)	0.50(0.020)	0.23(0.009)	0.66(0.026)	0.36(0.014)	0.46(0.018)
1608(0603)	1.78(0.070)	1.10(0.043)	0.95(0.037)	0.76(0.030)	0.30(0.012)	1.02(0.040)	0.64(0.025)	0.64(0.025)
2012(0805)	2.30(0.091)	1.70(0.067)	1.52(0.060)	1.27(0.050)	0.50(0.020)	1.78(0.070)	1.02(0.040)	0.76(0.030)
2520(1008)	2.92(0.115)	2.79(0.110)	2.10(0.083)	2.00(0.079)	0.50(0.020)	2.54(0.100)	1.02(0.040)	1.27(0.050)
3225(1210)	3.50(0.138)	2.90(0.114)	2.25(0.088)	2.10(0.083)	0.50(0.020)	2.54(0.100)	1.02(0.040)	1.78(0.070)
4532(1812)	4.80(0.189)	3.40(0.134)	3.15(0.124)	2.53(0.100)	0.65(0.026)	3.05(0.120)	1.14(0.045)	3.00(0.118)

(2)Product Spec. Model

**ASUW**    **0805**    **UC**    **R10**    **J**    **G**    **T**  
 A            B            C            D            E            F            G

A: Product type: Wire Wound Inductor Series  
 B: Dimensions: 0402、0603、0805、1008、1210、1812  
 C: Material: UC、HC-Ceramic core;UF、IF、QF、HF-Ferrite core  
 D: Inductance: 1N0=1.0nH、010=10nH、R10=100nH、1R0=1.0μH、100=10μH、101=100μH、102=1mH  
 E: Tolerance: F:±1%; G:±2%; J:±5%; K:±10%; M:±20%  
 F:Terminal: G:Gold,S:Tin  
 G:Packaging type: T:Tape&Reel;B:Bulk

DWG.No.	ASDIQ-SPE-194(00)	PAGE 3/19
---------	-------------------	--------------

## (3)Electrical Characteristics List

ASDI Part Number	Customer P/N	Tolerance (%)	Inductance (nH)	Ls Test frequency (MHz)	Q Value (Min)	Q Value Test frequency (MHz)	Rdc ( $\Omega$ ) max	Test voltage (mV)	SRF (MHz) min	Idc (mA) max
ASUW0402UC1N0KGT		$\pm 10$	1.0	250	13	250	0.045	500	10000	1360
ASUW0402UC1N2KGT		$\pm 10$	1.2	250	8	250	0.135	500	10000	640
ASUW0402UC1N8KGT		$\pm 10$	1.8	250	16	250	0.070	500	6000	1040
ASUW0402UC1N9KGT		$\pm 10$	1.9	250	16	250	0.070	500	6000	1040
ASUW0402UC2N0KGT		$\pm 10$	2.0	250	18	250	0.070	500	6000	1040
ASUW0402UC2N2KGT		$\pm 10$	2.2	250	18	250	0.070	500	6000	960
ASUW0402UC2N4KGT		$\pm 10$	2.4	250	16	250	0.080	500	6000	790
ASUW0402UC2N5KGT		$\pm 10$	2.5	250	15	250	0.120	500	6000	640
ASUW0402UC2N7KGT		$\pm 10$	2.7	250	15	250	0.120	500	6000	640
ASUW0402UC2N9KGT		$\pm 10$	2.9	250	8	250	0.300	500	6000	400
ASUW0402UC3N3JGT		$\pm 5$	3.3	250	20	250	0.066	500	6000	840
ASUW0402UC3N6JGT		$\pm 5$	3.6	250	20	250	0.066	500	6000	840
ASUW0402UC3N9JGT		$\pm 5$	3.9	250	20	250	0.066	500	6000	840
ASUW0402UC4N3JGT		$\pm 5$	4.3	250	20	250	0.091	500	6000	700
ASUW0402UC4N7JGT		$\pm 5$	4.7	250	18	250	0.200	500	4500	640
ASUW0402UC5N1JGT		$\pm 5$	5.1	250	18	250	0.083	500	4800	800
ASUW0402UC5N6JGT		$\pm 5$	5.6	250	20	250	0.083	500	4800	760
ASUW0402UC6N2JGT		$\pm 5$	6.2	250	23	250	0.083	500	4800	760
ASUW0402UC6N8JGT		$\pm 5$	6.8	250	23	250	0.260	500	4800	680
ASUW0402UC7N5JGT		$\pm 5$	7.5	250	23	250	0.100	500	4800	680
ASUW0402UC8N2JGT		$\pm 5$	8.2	250	25	250	0.100	500	4400	680
ASUW0402UC8N7JGT		$\pm 5$	8.7	250	25	250	0.200	500	4100	480
ASUW0402UC9N0JGT		$\pm 5$	9.0	250	25	250	0.100	500	4160	680
ASUW0402UC9N5JGT		$\pm 5$	9.5	250	25	250	0.200	500	4000	480
ASUW0402UC010JGT		$\pm 5$	10.0	250	25	250	0.200	500	3900	480
ASUW0402UC011JGT		$\pm 5$	11.0	250	25	250	0.120	500	3680	640

ASDI Part Number	Customer P/N	Tolerance (%)	Inductance (nH)	Ls Test frequency (MHz)	Q Value (Min)	Q Value Test frequency (MHz)	Rdc ( $\Omega$ ) max	Test voltage (mV)	SRF (MHz) min	Idc (mA) max
ASUW0402UC012JGT		±5	12	250	25	250	0.120	500	3600	640
ASUW0402UC013JGT		±5	13	250	25	250	0.210	500	3450	440
ASUW0402UC015JGT		±5	15	250	25	250	0.300	500	3280	560
ASUW0402UC016JGT		±5	16	250	25	250	0.220	500	3100	560
ASUW0402UC018JGT		±5	18	250	25	250	0.230	500	3100	420
ASUW0402UC019JGT		±5	19	250	25	250	0.200	500	3040	480
ASUW0402UC020JGT		±5	20	250	25	250	0.250	500	3000	420
ASUW0402UC022JGT		±5	22	250	25	250	0.300	500	2800	400
ASUW0402UC023JGT		±5	23	250	22	250	0.380	500	2720	310
ASUW0402UC024JGT		±5	24	250	25	250	0.300	500	2700	400
ASUW0402UC027JGT		±5	27	250	24	250	0.520	500	2480	280
ASUW0402UC030JGT		±5	30	250	25	250	0.500	500	2350	400
ASUW0402UC033JGT		±5	33	250	24	250	0.650	500	2350	350
ASUW0402UC036JGT		±5	36	250	25	250	0.600	500	2320	250
ASUW0402UC039JGT		±5	39	250	25	250	0.750	500	2100	200
ASUW0402UC040JGT		±5	40	250	25	250	0.600	500	2240	220
ASUW0402UC043JGT		±5	43	250	25	250	0.810	500	2030	100
ASUW0402UC047JGT		±5	47	250	25	250	0.830	500	2100	150
ASUW0402UC051JGT		±5	51	250	25	250	0.820	500	1750	100
ASUW0402UC056JGT		±5	56	250	25	250	0.970	500	1760	100
ASUW0402UC062JGT		±5	62	250	25	250	1.120	500	1620	100
ASUW0402UC068JGT		±5	68	250	25	250	1.120	500	1620	100
ASUW0402UC075JGT		±5	75	250	25	250	1.630	500	1400	50
ASUW0402UC082JGT		±5	82	250	25	250	1.700	500	1260	50
ASUW0402UCR10JGT		±5	100	250	25	250	2.000	500	1160	30
ASUW0402UCR12JGT		±5	120	250	25	250	2.200	500	1100	30

Note: ASUW0402 series products do not print labels.

ASDI Part Number	Customer P/N	Tolerance (%)	Inductance (nH)	LS Test frequency (MHz)	Q Value (Min)	Q Value Test frequency (MHz)	Rdc ( $\Omega$ ) max	Test voltage (mV)	SRF (MHz) min	Idc (mA)max
ASUW0603UC1N6KGT		±10	1.6	250	18	250	0.040	500	12500	700
ASUW0603UC1N8KGT		±10	1.8	250	16	250	0.045	500	12500	700
ASUW0603UC2N2KGT		±10	2.2	250	12	250	0.090	500	10000	700
ASUW0603UC3N3KGT		±10	3.3	250	20	250	0.075	500	5900	700
ASUW0603UC3N9JGT		±5	3.9	250	22	250	0.080	500	6900	700
ASUW0603UC4N7JGT		±5	4.7	250	20	250	0.116	500	5800	700
ASUW0603UC5N6KGT		±10	5.6	250	18	250	0.200	500	5700	700
ASUW0603UC6N8JGT		±5	6.8	250	27	250	0.110	500	5800	700
ASUW0603UC7N5JGT		±5	7.5	250	28	250	0.110	500	4800	700
ASUW0603UC8N2JGT		±5	8.2	250	28	250	0.120	500	4700	700
ASUW0603UC010JGT		±5	10	250	31	250	0.130	500	4800	700
ASUW0603UC012JGT		±5	12	250	35	250	0.130	500	4000	700
ASUW0603UC015JGT		±5	15	250	30	250	0.150	500	4000	700
ASUW0603UC018JGT		±5	18	250	35	250	0.170	500	3100	700
ASUW0603UC022JGT		±5	22	250	38	250	0.190	500	3000	700
ASUW0603UC027JGT		±5	27	250	36	250	0.220	500	2800	600
ASUW0603UC033JGT		±5	33	250	36	250	0.220	500	2300	600
ASUW0603UC039JGT		±5	39	250	40	250	0.250	500	2200	600
ASUW0603UC047JGT		±5	47	200	36	200	0.280	500	2000	600
ASUW0603UC056JGT		±5	56	200	38	200	0.280	500	1900	600
ASUW0603UC068JGT		±5	68	200	36	200	0.340	500	1700	600
ASUW0603UC082JGT		±5	82	150	34	150	0.550	500	1700	400
ASUW0603UCR10JGT		±5	100	150	30	150	0.630	500	1400	400
ASUW0603UCR12JGT		±5	120	150	32	150	0.730	500	1300	300
ASUW0603UCR15JGT		±5	150	150	28	150	0.800	500	990	280
ASUW0603UCR18JGT		±5	180	100	25	100	1.450	500	990	240
ASUW0603UCR22JGT		±5	220	100	25	100	2.100	500	900	200
ASUW0603UCR27JGT		±5	270	100	24	100	2.300	500	900	170
ASUW0603UCR33JGT		±5	330	100	25	100	3.890	500	900	100
ASUW0603UCR39JGT		±5	390	100	25	100	4.350	500	800	100
ASUW0603UCR47JGT		±5	470	100	25	100	7.000	500	700	75

Note: ASUW0603 series products do not print labels.



ASDI Part Number	Customer P/N	Tolerance (%)	Inductance (nH)	LS Test frequency (MHz)	Q Value (Min)	Q Value Test frequency (MHz)	Rdc ( $\Omega$ ) max	Test voltage (mV)	SRF (MHz) min	Idc (mA) max
ASUW0805UC2N2KGT		$\pm 10$	2.2	250	50	1500	0.030	500	8500	800
ASUW0805UC2N7JGT		$\pm 5$	2.7	250	50	1500	0.045	500	8000	800
ASUW0805UC3N3KGT		$\pm 10$	3.3	250	35	1500	0.090	500	7900	600
ASUW0805UC4N7KGT		$\pm 10$	4.7	250	40	1000	0.050	500	6000	600
ASUW0805UC5N6JGT		$\pm 5$	5.6	250	50	1000	0.065	500	5500	600
ASUW0805UC6N8JGT		$\pm 5$	6.8	250	50	1000	0.110	500	5500	600
ASUW0805UC8N2JGT		$\pm 5$	8.2	250	35	1000	0.200	500	4700	600
ASUW0805UC010JGT		$\pm 5$	10	250	50	500	0.150	500	4200	600
ASUW0805UC012JGT		$\pm 5$	12	250	50	500	0.150	500	4000	600
ASUW0805UC015JGT		$\pm 5$	15	250	45	500	0.170	500	3400	600
ASUW0805UC018JGT		$\pm 5$	18	250	55	500	0.200	500	3300	600
ASUW0805UC022JGT		$\pm 5$	22	250	55	500	0.220	500	2600	500
ASUW0805UC027JGT		$\pm 5$	27	250	55	500	0.250	500	2500	500
ASUW0805UC033JGT		$\pm 5$	33	250	55	500	0.270	500	2050	500
ASUW0805UC039JGT		$\pm 5$	39	250	55	500	0.290	500	2000	500
ASUW0805UC047JGT		$\pm 5$	47	200	55	500	0.310	500	1650	500
ASUW0805UC056JGT		$\pm 5$	56	200	55	500	0.340	500	1550	500
ASUW0805UC068JGT		$\pm 5$	68	200	55	500	0.380	500	1450	500
ASUW0805UC082JGT		$\pm 5$	82	150	55	500	0.420	500	1300	400
ASUW0805UCR10JGT		$\pm 5$	100	150	50	500	0.460	500	1200	400
ASUW0805UCR12JGT		$\pm 5$	120	150	45	250	0.510	500	1100	400
ASUW0805UCR15JGT		$\pm 5$	150	100	45	250	0.560	500	920	400
ASUW0805UCR18JGT		$\pm 5$	180	100	45	250	0.640	500	870	400
ASUW0805UCR22JGT		$\pm 5$	220	100	40	250	1.050	500	850	400
ASUW0805UCR27JGT		$\pm 5$	270	100	40	250	1.100	500	650	350
ASUW0805UCR33JGT		$\pm 5$	330	100	40	250	1.400	500	600	310
ASUW0805UCR39JGT		$\pm 5$	390	100	40	250	1.500	500	560	290
ASUW0805UCR47JGT		$\pm 5$	470	50	33	100	2.000	500	375	250
ASUW0805UCR56JGT		$\pm 5$	560	25	23	50	1.900	500	340	230
ASUW0805UCR68JGT		$\pm 5$	680	25	23	50	2.100	500	300	190
ASUW0805UCR82JGT		$\pm 5$	820	25	23	50	2.140	500	250	180
ASUW0805UC1R0JGT		$\pm 5$	1000	25	20	50	2.400	500	200	170
ASUW0805UC1R2JGT		$\pm 5$	1200	7.9	18	50	2.550	500	180	170
ASUW0805UC1R5JGT		$\pm 5$	1500	7.9	18	50	2.800	500	170	160
ASUW0805UC1R8JGT		$\pm 5$	1800	7.9	18	50	3.800	500	140	150
ASUW0805UC2R2JGT		$\pm 5$	2200	7.9	16	7.9	4.200	500	50	150

DWG.No.

ASDIQ-SPE-194(00)

PAGE  
7/19

ASDI Part Number	Customer P/N	Tolerance (%)	Inductance (nH)	LS Test frequency (MHz)	Q Value (Min)	Q Value Test frequency (MHz)	Rdc ( $\Omega$ ) max	Test voltage (mV)	SRF (MHz) min	Idc (mA) max
ASUW1008UC3N9JGT		±5	3.9	50	50	1500	0.035	500	6000	1000
ASUW1008UC4N7JGT		±5	4.7	50	50	1500	0.045	500	6000	1000
ASUW1008UC5N6JGT		±5	5.6	50	30	1000	0.180	500	6000	1000
ASUW1008UC010JGT		±5	10	50	50	500	0.080	500	4100	1000
ASUW1008UC012JGT		±5	12	50	50	500	0.090	500	3300	1000
ASUW1008UC015JGT		±5	15	50	45	500	0.150	500	2500	1000
ASUW1008UC018JGT		±5	18	50	50	350	0.110	500	2500	1000
ASUW1008UC022JGT		±5	22	50	55	350	0.120	500	2400	1000
ASUW1008UC027JGT		±5	27	50	55	350	0.130	500	1600	1000
ASUW1008UC033JGT		±5	33	50	60	350	0.140	500	1600	1000
ASUW1008UC039JGT		±5	39	50	60	350	0.150	500	1500	1000
ASUW1008UC047JGT		±5	47	50	65	350	0.160	500	1500	1000
ASUW1008UC056JGT		±5	56	50	65	350	0.180	500	1100	1000
ASUW1008UC068JGT		±5	68	50	65	350	0.200	500	1000	1000
ASUW1008UC082JGT		±5	82	50	60	350	0.220	500	1000	1000
ASUW1008UCR10JGT		±5	100	25	60	350	0.560	500	1000	650
ASUW1008UCR12JGT		±5	120	25	60	350	0.630	500	950	650
ASUW1008UCR15JGT		±5	150	25	45	100	0.700	500	800	580
ASUW1008UCR18JGT		±5	180	25	45	100	0.770	500	640	620
ASUW1008UCR22JGT		±5	220	25	45	100	0.840	500	620	500
ASUW1008UCR27JGT		±5	270	25	45	100	0.910	500	600	500
ASUW1008UCR33JGT		±5	330	25	45	100	1.050	500	500	450
ASUW1008UCR39JGT		±5	390	25	45	100	1.120	500	480	470
ASUW1008UCR47JGT		±5	470	25	45	100	1.190	500	450	470
ASUW1008UCR56JGT		±5	560	25	45	100	1.330	500	415	400
ASUW1008UCR68JGT		±5	680	25	45	100	1.470	500	375	400
ASUW1008UCR82JGT		±5	820	25	45	100	1.610	500	250	400
ASUW1008UC1R0JGT		±5	1000	25	35	50	1.750	500	210	370
ASUW1008UC1R2JGT		±5	1200	7.9	35	50	2.000	500	200	310
ASUW1008UC1R5JGT		±5	1500	7.9	28	50	2.300	500	180	330
ASUW1008UC1R8JGT		±5	1800	7.9	28	50	2.600	500	160	300
ASUW1008UC2R2JGT		±5	2200	7.9	20	50	2.800	500	90	280
ASUW1008UC2R7JGT		±5	2700	7.9	22	25	3.200	500	80	290
ASUW1008UC3R3JGT		±5	3300	7.9	22	25	3.400	500	70	290
ASUW1008UC3R9JGT		±5	3900	7.9	16	25	3.600	500	60	260
ASUW1008UC4R7JGT		±5	4700	7.9	18	25	4.000	500	60	260
ASUW1008UC5R6JGT		±5	5600	7.9	18	7.9	7.600	500	55	240
ASUW1008UC6R8JGT		±5	6800	7.9	18	7.9	8.200	500	50	200
ASUW1008UC8R2JGT		±5	8200	7.9	18	7.9	8.200	500	40	170
ASUW1008UC100JGT		±5	10000	7.9	20	7.9	9.100	500	40	160

ASDI Part Number	Customer P/N	Tolerance (%)	Inductance (nH)	LS Test frequency (MHz)	Q Value (Min)	Q Value Test frequency (MHz)	Rdc (Ω) max	Test voltage (mV)	SRF (MHz) min	Idc (mA) max
ASUW1210HC3N9KGT		±10	3.9	100	30	300	0.050	500	6000	1000
ASUW1210HC4N7JGT		±5	4.7	100	30	300	0.065	500	5800	1000
ASUW1210HC8N2KGT		±10	8.2	100	30	300	0.070	500	5500	1000
ASUW1210HC010JGT		±5	10	100	40	300	0.080	500	4000	1000
ASUW1210HC012JGT		±5	12	100	40	300	0.080	500	3200	1000
ASUW1210HC015JGT		±5	15	100	40	300	0.100	500	3200	1000
ASUW1210HC018JGT		±5	18	100	50	300	0.100	500	2800	1000
ASUW1210HC022JGT		±5	22	100	50	300	0.100	500	2000	1000
ASUW1210HC027JGT		±5	27	100	50	300	0.110	500	1800	1000
ASUW1210HC033JGT		±5	33	100	55	300	0.110	500	1800	1000
ASUW1210HC039JGT		±5	39	100	55	300	0.120	500	1800	1000
ASUW1210HC047JGT		±5	47	100	55	300	0.130	500	1500	1000
ASUW1210HC056JGT		±5	56	100	55	300	0.140	500	1450	1000
ASUW1210HC068JGT		±5	68	100	55	300	0.150	500	1200	900
ASUW1210HC082JGT		±5	82	100	55	300	0.200	500	1000	900
ASUW1210HCR10JGT		±5	100	100	55	300	0.210	500	900	850
ASUW1210HCR12JGT		±5	120	100	60	300	0.210	500	800	800
ASUW1210HCR15JGT		±5	150	100	60	300	0.250	500	780	750
ASUW1210HCR18JGT		±5	180	50	60	300	0.300	500	760	700
ASUW1210HCR22JGT		±5	220	50	60	300	0.320	500	650	670
ASUW1210HCR27JGT		±5	270	50	55	300	0.340	500	620	630
ASUW1210HCR33JGT		±5	330	50	45	150	0.380	500	600	590
ASUW1210HCR39JGT		±5	390	50	45	150	0.580	500	510	530
ASUW1210HCR47JGT		±5	470	50	45	150	0.800	500	500	490
ASUW1210HCR56JGT		±5	560	35	45	150	1.100	500	420	460
ASUW1210HCR68JGT		±5	680	35	45	150	1.200	500	400	430
ASUW1210HCR82JGT		±5	820	35	45	150	1.820	500	370	400
ASUW1210HC1R0JGT		±5	1000	35	45	150	1.850	500	340	320
ASUW1210HC1R2JGT		±5	1200	35	35	150	1.870	500	220	300
ASUW1210HC1R5JGT		±5	1500	7.9	30	50	1.950	500	160	310
ASUW1210HC1R8JGT		±5	1800	7.9	30	50	2.250	500	160	310
ASUW1210HC2R2JGT		±5	2200	7.9	30	50	2.410	500	110	310
ASUW1210HC2R7JGT		±5	2700	7.9	25	25	2.850	500	100	300
ASUW1210HC3R3JGT		±5	3300	7.9	20	25	3.120	500	85	300
ASUW1210HC3R9JGT		±5	3900	7.9	20	25	3.600	500	80	290
ASUW1210HC4R7JGT		±5	4700	7.9	16	25	4.000	500	60	280
ASUW1210HC5R6JGT		±5	5600	7.9	20	7.9	5.000	500	60	250
ASUW1210HC6R8JGT		±5	6800	7.9	20	7.9	8.000	500	55	230
ASUW1210HC8R2JGT		±5	8200	7.9	20	7.9	8.600	500	50	170
ASUW1210HC100JGT		±5	10000	7.9	22	7.9	6.800	500	20	200

ASDI Part Number	Customer P/N	Tolerance (%)	Inductance (μH)	Ls Test frequency (MHz)	Q Value (Min)	Q Value Test frequency (MHz)	Rdc (Ω) max	Test voltage (mV)	SRF (MHz) min	Idc (mA) max
ASUW0603UFR10JST		±5	0.10	7.9	12	7.9	0.13	500	1150	1000
ASUW0603UFR12JST		±5	0.12	7.9	12	7.9	0.16	500	1100	1000
ASUW0603UFR15JST		±5	0.15	7.9	12	7.9	0.15	500	1050	1000
ASUW0603UFR18JST		±5	0.18	7.9	12	7.9	0.15	500	950	1000
ASUW0603UFR22JST		±5	0.22	7.9	12	7.9	0.20	500	900	900
ASUW0603UFR27JST		±5	0.27	7.9	12	7.9	0.30	500	775	700
ASUW0603UFR33JST		±5	0.33	7.9	12	7.9	0.32	500	725	600
ASUW0603UFR39JST		±5	0.39	7.9	12	7.9	0.51	500	620	500
ASUW0603UFR47JST		±5	0.47	7.9	12	7.9	0.62	500	540	420
ASUW0603UFR56JST		±5	0.56	7.9	12	7.9	0.65	500	600	400
ASUW0603UFR68JST		±5	0.68	7.9	12	7.9	1.00	500	500	380
ASUW0603UFR82JST		±5	0.82	7.9	12	7.9	1.30	500	500	350
ASUW0603UF1R0JST		±5	1.00	7.9	12	7.9	1.50	500	400	330
ASUW0603UF1R2JST		±5	1.20	7.9	12	7.9	1.70	500	380	320
ASUW0603UF1R5JST		±5	1.50	7.9	12	7.9	1.90	500	300	310
ASUW0603UF1R8JST		±5	1.80	7.9	12	7.9	2.20	500	180	300
ASUW0603UF2R2JST		±5	2.20	7.9	12	7.9	2.30	500	180	280
ASUW0603UF2R7JST		±5	2.70	7.9	12	7.9	3.10	500	150	250
ASUW0603UF3R3JST		±5	3.30	7.9	12	7.9	2.90	500	150	230
ASUW0603UF3R9JST		±5	3.90	7.9	12	7.9	3.20	500	120	210
ASUW0603UF4R7JST		±5	4.70	7.9	12	7.9	4.00	500	100	200

ASDI Part Number	Customer P/N	Tolerance (%)	Inductance (μH)	Ls Test frequency (MHz)	Q Value (Min)	Q Value Test frequency (MHz)	Rdc (Ω) max	Test voltage (mV)	SRF (MHz) min	Idc (mA)max
ASUW0805UFR47JST		±5	0.47	25.2	10	25.2	0.40	500	450	500
ASUW0805UFR56JST		±5	0.56	25.2	10	25.2	0.40	500	450	500
ASUW0805UFR68JST		±5	0.68	25.2	10	25.2	0.60	500	400	500
ASUW0805UFR82JST		±5	0.82	25.2	10	25.2	0.80	500	400	500
ASUW0805UF1R0JST		±5	1.00	7.96	10	7.96	1.00	500	360	430
ASUW0805UF1R2JST		±5	1.20	7.96	10	7.96	1.15	500	350	410
ASUW0805UF1R5JST		±5	1.50	7.96	10	7.96	1.20	500	300	400
ASUW0805UF1R8JST		±5	1.80	7.96	10	7.96	1.35	500	200	380
ASUW0805UF2R2JST		±5	2.20	7.96	10	7.96	1.50	500	170	350
ASUW0805UF2R7JST		±5	2.70	7.96	10	7.96	1.70	500	100	320
ASUW0805UF3R3JST		±5	3.30	7.96	10	7.96	1.80	500	90	300
ASUW0805UF3R9JST		±5	3.90	7.96	10	7.96	1.95	500	90	280
ASUW0805UF4R7JST		±5	4.70	7.96	10	7.96	2.05	500	85	250
ASUW0805UF5R6JST		±5	5.60	7.96	10	7.96	2.30	500	70	240
ASUW0805UF6R8JST		±5	6.80	7.96	10	7.96	2.60	500	55	220
ASUW0805UF8R2JST		±5	8.20	7.96	10	7.96	3.00	500	50	180
ASUW0805UF100JST		±5	10.00	2.52	8	2.52	3.20	500	30	150
ASUW0805UF120JST		±5	12.00	2.52	8	2.52	3.50	500	17	110
ASUW0805UF150JST		±5	15.00	2.52	8	2.52	4.20	500	16	100
ASUW0805UF180JST		±5	18.00	2.52	8	2.52	4.50	500	15	95
ASUW0805UF220JST		±5	22.00	2.52	8	2.52	6.00	500	14	80

ASDI Part Number	Customer P/N	Tolerance (%)	Inductance (μH)	Ls Test frequency (MHz)	Q Value (Min)	Q Value Test frequency (MHz)	Rdc (Ω) max	Test voltage (mV)	SRF (MHz) min	Idc (mA) max
ASUW1008IFR12JST		±5	0.12	25.2	12	25.2	0.15	500	850	800
ASUW1008IFR39JST		±5	0.39	25.2	12	25.2	0.29	500	480	600
ASUW1008IFR56JST		±5	0.56	25.2	12	25.2	0.42	500	330	600
ASUW1008IFR68JST		±5	0.68	25.2	12	25.2	0.45	500	330	600
ASUW1008IFR82JST		±5	0.82	25.2	12	25.2	0.62	500	300	600
ASUW1008IF1R0JST		±5	1	25.2	12	25.2	0.55	500	300	580
ASUW1008IF1R2JST		±5	1.2	7.96	12	7.96	0.75	500	250	550
ASUW1008IF1R5JST		±5	1.5	7.96	12	7.96	0.85	500	230	400
ASUW1008IF1R8JST		±5	1.8	7.96	12	7.96	0.95	500	168	320
ASUW1008IF2R2JST		±5	2.2	7.96	12	7.96	1.30	500	150	315
ASUW1008IF2R7JST		±5	2.7	7.96	12	7.96	1.40	500	100	300
ASUW1008IF3R3JST		±5	3.3	7.96	12	7.96	1.50	500	80	280
ASUW1008IF3R9JST		±5	3.9	7.96	12	7.96	1.55	500	60	250
ASUW1008IF4R7JST		±5	4.7	7.96	12	7.96	1.75	500	50	210
ASUW1008IF5R6JST		±5	5.6	7.96	12	7.96	1.90	500	40	190
ASUW1008IF6R8JST		±5	6.8	7.96	12	7.96	2.00	500	35	175
ASUW1008IF8R2JST		±5	8.2	7.96	12	7.96	2.20	500	25	160
ASUW1008IF100JST		±5	10	2.52	10	2.52	2.50	500	25	155
ASUW1008IF120JST		±5	12	2.52	10	2.52	2.60	500	20	145
ASUW1008IF150JST		±5	15	2.52	10	2.52	3.00	500	20	130
ASUW1008IF180JST		±5	18	2.52	10	2.52	3.00	500	20	130
ASUW1008IF220JST		±5	22	2.52	10	2.52	3.90	500	18	105
ASUW1008IF270JST		±5	27	2.52	10	2.52	4.00	500	10	100
ASUW1008IF330JST		±5	33	2.52	10	2.52	4.80	500	8	85
ASUW1008IF390JST		±5	39	2.52	10	2.52	5.00	500	7	80
ASUW1008IF470JST		±5	47	2.52	10	2.52	5.70	500	7	60
ASUW1008IF560JST		±5	56	2.52	10	2.52	6.00	500	6.5	55
ASUW1008IF680JST		±5	68	2.52	10	2.52	6.70	500	6.5	50
ASUW1008IF820JST		±5	82	2.52	10	2.52	7.50	500	6.5	45
ASUW1008IF101JST		±5	100	0.796	8	0.796	11.00	500	4.5	40
ASUW1008IF121JST		±5	120	0.796	8	0.796	13.00	500	3	30
ASUW1008IF151JST		±5	150	0.796	8	0.796	15.00	500	3	25
ASUW1008IF221KST		±10	220	0.796	8	0.796	18.00	500	2.5	20

ASDI Part Number	Customer P/N	Tolerance (%)	Inductance (μH)	Ls Test frequency (MHz)	Q Value (Min)	Q Value Test frequency (MHz)	Rdc (Ω) max	Test voltage (mV)	SRF (MHz) min	Idc (mA) max
ASUW1210IF1R0JST		±5	1	7.96	12	7.96	0.3	500	220	450
ASUW1210IF1R2JST		±5	1.2	7.96	12	7.96	0.3	500	210	450
ASUW1210IF1R5JST		±5	1.5	7.96	12	7.96	0.4	500	200	450
ASUW1210IF1R8JST		±5	1.8	7.96	12	7.96	0.5	500	195	450
ASUW1210IF2R2JST		±5	2.2	7.96	12	7.96	0.6	500	175	450
ASUW1210IF2R7JST		±5	2.7	7.96	12	7.96	0.7	500	120	420
ASUW1210IF3R3JST		±5	3.3	7.96	12	7.96	1.1	500	80	380
ASUW1210IF3R9JST		±5	3.9	7.96	12	7.96	1.2	500	75	360
ASUW1210IF4R7JST		±5	4.7	7.96	12	7.96	1.3	500	60	350
ASUW1210IF5R6JST		±5	5.6	7.96	12	7.96	2.0	500	50	320
ASUW1210IF6R8JST		±5	6.8	7.96	12	7.96	1.5	500	35	310
ASUW1210IF8R2JST		±5	8.2	7.96	12	7.96	1.6	500	35	305
ASUW1210IF100JST		±5	10	2.52	10	2.52	1.0	500	30	300
ASUW1210IF120JST		±5	12	2.52	10	2.52	1.2	500	25	265
ASUW1210IF150JST		±5	15	2.52	10	2.52	2.0	500	22	225
ASUW1210IF180JST		±5	18	2.52	10	2.52	2.1	500	22	210
ASUW1210IF220JST		±5	22	2.52	10	2.52	2.4	500	20	200
ASUW1210IF270JST		±5	27	2.52	10	2.52	2.7	500	18	180
ASUW1210IF330JST		±5	33	2.52	10	2.52	2.9	500	15	160
ASUW1210IF390JST		±5	39	2.52	10	2.52	4.7	500	16	150
ASUW1210IF470JST		±5	47	2.52	10	2.52	5.2	500	10	140
ASUW1210IF560JST		±5	56	2.52	10	2.52	5.6	500	8.0	125
ASUW1210IF680JST		±5	68	2.52	10	2.52	4.7	500	5.0	110
ASUW1210IF820JST		±5	82	2.52	10	2.52	5.6	500	5.0	100
ASUW1210IF101JST		±5	100	0.796	8	0.796	6.8	500	5.0	95
ASUW1210IF121JST		±5	120	0.796	8	0.796	7.9	500	4.0	85
ASUW1210IF151JST		±5	150	0.796	8	0.796	9.0	500	4.0	80
ASUW1210IF181JST		±5	180	0.796	8	0.796	14.5	500	3.0	70
ASUW1210IF221JST		±5	220	0.796	8	0.796	16.5	500	2.6	65
ASUW1210IF271KST		±10	270	0.796	8	0.796	18.0	500	2.5	60
ASUW1210IF331KST		±10	330	0.796	8	0.796	19.0	500	2.3	55
ASUW1210IF391KST		±10	390	0.796	8	0.796	21.5	500	2.2	45
ASUW1210IF471KST		±10	470	0.796	8	0.796	22.5	500	2.0	40

ASDI Part Number	Customer P/N	Tolerance (%)	Inductance (μH)	Ls Test frequency (MHz)	Q Value (Min)	Q Value Test frequency (MHz)	Rdc (Ω) max	Test voltage (mV)	SRF (MHz) min	Idc (mA) max
ASUW1812IFR33JST		±5	0.33	25.2	10	25.2	0.13	500	380	1000
ASUW1812IFR56JST		±5	0.56	25.2	10	25.2	0.15	500	300	1000
ASUW1812IF1R0JST		±5	1	7.96	15	7.96	0.22	500	200	1000
ASUW1812IF1R2JST		±5	1.2	7.96	15	7.96	0.35	500	200	1000
ASUW1812IF1R5JST		±5	1.5	7.96	15	7.96	0.32	500	180	1000
ASUW1812IF1R8JST		±5	1.8	7.96	15	7.96	0.35	500	160	950
ASUW1812IF2R2JST		±5	2.2	7.96	15	7.96	0.37	500	150	900
ASUW1812IF2R7JST		±5	2.7	7.96	15	7.96	0.37	500	145	850
ASUW1812IF3R3JST		±5	3.3	7.96	15	7.96	0.48	500	140	800
ASUW1812IF3R9JST		±5	3.9	7.96	15	7.96	0.60	500	135	750
ASUW1812IF4R7JST		±5	4.7	7.96	15	7.96	1.00	500	120	700
ASUW1812IF5R6JST		±5	5.6	7.96	15	7.96	0.55	500	110	650
ASUW1812IF6R8JST		±5	6.8	7.96	15	7.96	0.80	500	80	600
ASUW1812IF8R2JST		±5	8.2	7.96	10	7.96	0.85	500	70	600
ASUW1812IF100JST		±5	10	2.52	10	2.52	1.00	500	65	550
ASUW1812IF120JST		±5	12	2.52	10	2.52	1.10	500	55	550
ASUW1812IF150JST		±5	15	2.52	10	2.52	1.20	500	35	500
ASUW1812IF180JST		±5	18	2.52	10	2.52	1.20	500	29	500
ASUW1812IF220JST		±5	22	2.52	10	2.52	1.30	500	20	450
ASUW1812IF270JST		±5	27	2.52	10	2.52	1.50	500	20	400
ASUW1812IF330JST		±5	33	2.52	10	2.52	1.70	500	18	350
ASUW1812IF390JST		±5	39	2.52	10	2.52	1.80	500	14	350
ASUW1812IF470JST		±5	47	2.52	10	2.52	2.00	500	10	300
ASUW1812IF560JST		±5	56	2.52	10	2.52	2.20	500	10	290
ASUW1812IF680JST		±5	68	2.52	10	2.52	2.40	500	5.4	260
ASUW1812IF820JST		±5	82	2.52	10	2.52	2.80	500	5.2	240
ASUW1812IF101JST		±5	100	0.796	10	0.796	3.00	500	4.0	220
ASUW1812IF121JST		±5	120	0.796	10	0.796	3.30	500	3.3	220
ASUW1812IF151JST		±5	150	0.796	10	0.796	3.70	500	3.0	200
ASUW1812IF181JST		±5	180	0.796	10	0.796	4.50	500	3.0	200
ASUW1812IF221JST		±5	220	0.796	10	0.796	8.00	500	2.5	170
ASUW1812IF271JST		±5	270	0.796	10	0.796	8.50	500	2.2	160
ASUW1812IF331KST		±10	330	0.796	10	0.796	9.00	500	2.0	150
ASUW1812IF391KST		±10	390	0.796	10	0.796	9.50	500	1.8	130
ASUW1812IF471KST		±10	470	0.796	8	0.796	10.40	500	1.6	120
ASUW1812IF561KST		±10	560	0.796	8	0.796	12.50	500	1.5	110
ASUW1812IF681KST		±10	680	0.796	8	0.796	14.00	500	1.5	100
ASUW1812IF821KST		±10	820	0.796	8	0.796	15.00	500	1.5	95
ASUW1812IF102KST		±10	1000	0.252	6	0.252	16.50	500	1.4	90

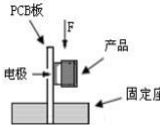

## (4)Reliability Testing Items

No.	Items	Requirements	Test Methods and Remarks
1	Operating Temperature Range	ASUW-UC/HC series: $-40^{\circ}\text{C}\sim+125^{\circ}\text{C}$ ASUW-UF/IF/QF/HF series: $-40^{\circ}\text{C}\sim+85^{\circ}\text{C}$	
2	Solder ability	There shall be no case deformation or change in appearance. The metalized area must have more than 90% solder coverage.	Dip pads in flux and dip in solder pot(96.5Sn/3.0Ag/0.5Cu)at $245\pm 5^{\circ}\text{C}$ for $5\pm 1$ seconds.
3	Soldering Heat Resistance	There shall be no case deformation or change in appearance. Inductance shall not change more than $\pm 5\%$ ; Q shall not change more than $\pm 10\%$ .	Dip pads in flux and dip in solder pot(96.5Sn/3.0Ag/0.5Cu)at $260\pm 5^{\circ}\text{C}$ for $10\pm 1$ seconds.
4	Dielectric Withstand Voltage	here shall be no case deformation or change in appearance.No evidence of voltage breakdown.	Input 500v AC between the electrodes and the resin of inductor and keep on one minute.
5	Insulation Resistance	Ferrite: $\geq 500\text{M}\Omega$ Ceramic: $\geq 1000\text{M}\Omega$	Input 100v DC between the electrodes and the resin of inductor and keep on one minute.
6	Component Adhesion (Push of test)	Wire Wound Chip inductor: 0402UC series: $\geq 0.45\text{Kg}$ 0603UF series: $\geq 0.9\text{Kg}$ 0603UC series、0805UF series: $\geq 1.3\text{Kg}$ Other series: $\geq 2\text{Kg}$	
8	Over Loading	There shall be no case deformation or change in appearance. Inductors shall not have a open winding.	Direct current of rating current between inductor terminals , Direct current error $\pm 2\%$ , and keep on five minutes.
7	Vibration	Inductors shall not have a shorted or open winding. Inductance shall not change more than $\pm 5\%$ . Q shall not change more than $\pm 10\%$ .	Inductors shall be subjected to vibration of 1.5mm amplitude frequency 10~55Hz (10Hz to 55Hz to 10Hz in a period of 1 minute) for 2 hours in each of three(X、Y、Z) axes.
8	Temperature Change	There shall be no case deformation or change in appearance. Inductance shall not change more than $\pm 5\%$ . Q shall not change more than $\pm 10\%$ .	ASUW-UC/HC series : $+125^{\circ}\text{C}$ 60minutes $\leftrightarrow$ $-40^{\circ}\text{C}$ 60minutes 5 Cycles; ASUW-UF/IF/QF/HF series : $+85^{\circ}\text{C}$ 60minutes $\leftrightarrow$ $-40^{\circ}\text{C}$ 60minutes 5 Cycles; Inductors are to be tested after 1 hour at room temperature.
9	High temperature	There shall be no case deformation or change in appearance. Inductance shall not change more than $\pm 5\%$ . Q shall not change more than $\pm 10\%$ .	ASUW-UC/HC series shall be subjected to $+125\pm 5^{\circ}\text{C}$ for 96 $\pm 2$ hours; ASUW-UF/IF/QF/HF series shall be subjected to $+85\pm 5^{\circ}\text{C}$ for 96 $\pm 2$ hours; Inductors are to be tested after one hour at room temperature.
10	Low temperature	There shall be no case deformation or change in appearance. Inductance shall not change more than $\pm 5\%$ . Q shall not change more than $\pm 10\%$ .	Inductors shall be subjected to $-40\pm 2^{\circ}\text{C}$ for 96 $\pm 2$ hours. Inductors are to be tested after one hour at room temperature.
11	Static Humidity	There shall be no case deformation or change in appearance. Inductance shall not change more than $\pm 5\%$ . Q shall not change more than $\pm 10\%$ .	Inductors shall be subjected to 93 $\pm 3\%$ R.H. at $50\pm 2^{\circ}\text{C}$ for 96 $\pm 2$ hours .Inductors are to be tested after having air dried for one hour.
12	durability (Life)	Inductors shall not have a shorted or open winding.	ASUW-UC/HC series shall be store at $125\pm 2^{\circ}\text{C}$ for 1000 hours with rated current applied; ASUW-UF/IF/QF/HF series shall be store at $85\pm 2^{\circ}\text{C}$ for 1000 hours with rated current applied; Inductors shall be tested after four hours at room temperature.
<b>Note: When there are questions concerning, test within 48 h after placing at room temperature for at least 2 h.</b>			

DWG.No.

ASDIQ-SPE-108(00)

PAGE  
15/19

(5)Packaging

5-1,Taping drawings

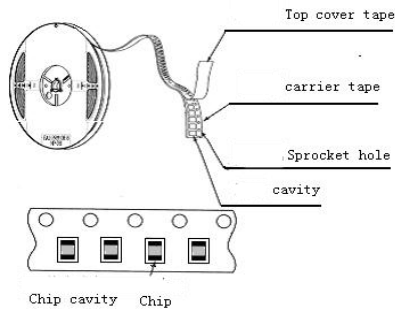

5-2,Reel dimensions (Unit: mm)

Part NO.	ΦA typ.	ΦB typ.	ΦC typ.	D typ.
0402-1210	178	60	13	8.4
1812	330	98	13	16.4

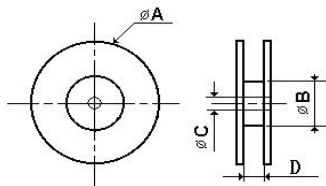

5-3,Leader and blank portion

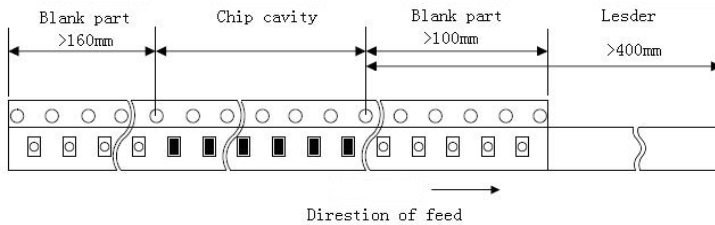

DWG.No.	ASDIQ-SPE-108(00)	PAGE 16/19
---------	-------------------	---------------

5-4, Taping dimensions (Unit: mm)

·Paper tape

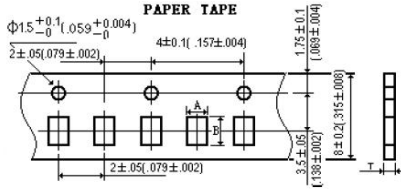

Part NO.	A	B	T
0402	0.74	1.23	0.60

·Embossed tape

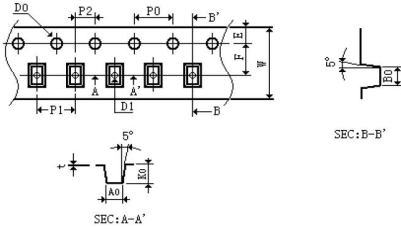

Part NO.	0603	0805	1008	1210	1812
W	8.00	8.00	8.00	8.00	12.00
E	1.75	1.75	1.75	1.75	1.75
F	3.50	3.50	3.50	3.50	5.50
D0	1.50	1.50	1.50	1.50	1.50
D1	0.50	0.65	0.65	0.65	1.50
P0	4.00	4.00	4.00	4.00	4.00
P1	4.00	4.00	4.00	4.00	8.00
P2	2.00	2.00	2.00	2.00	2.00
P0×10	40.00	40.00	40.00	40.00	40.00
t	0.23	0.23	0.25	0.23	0.25
A0	1.15	1.85	2.73	2.96	3.22
B0	1.85	2.45	2.90	3.60	4.82
K0	0.95	1.50	2.34	2.40	2.98

5-5, Peeling off force

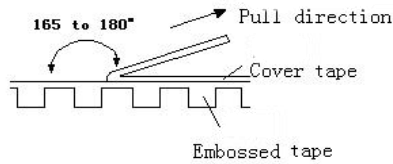
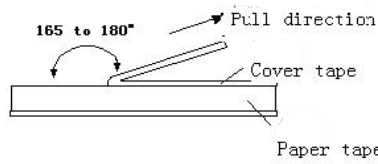

- ① Peeling required: 0402~1210series : 20g~80g; 1812: 20G~100G
- ② Test condition: Speed of peeling off : 300mm/min±10%  
Angle of peeling off: 165°~180°

5-6, Packaging number (Unit: Pcs)

Size	1812	1210	1008	805	603	402
Per Reel	2000	2000	2000	3000	4000	5000
Per Box	3 box	-----	6000	6000	9000	15000
	5 box	10000	10000	10000	15000	20000
	10 box	-----	20000	20000	30000	40000
Per Case	1.5 box	-----	30000	30000	45000	60000
	3 box	-----	60000	60000	90000	120000
	4 box	-----	80000	80000	120000	160000
	6 box	-----	120000	120000	180000	240000
	Big 3 box	30000	-----	-----	-----	-----

5-7, Label stick station



(6) Recommend Soldering Conditions

6-1, Soldering Conditions

Reflow soldering is applied to this product.

① Flux, Solder

- Don't use highly acidic flux with halide content exceeding 0.2(wt)%(chlorine conversion value).
- Using lead-free solder (96.5Sn /3.0Ag/0.5Cu).

② Soldering conditions

·Pre-heating should be in such a way that the temperature difference between solder and ferrite surface is limited to 150°C max. Also cooling into solvent after soldering should be in such way that the temperature difference is limited to 100°C max. Un-enough pre-heating may cause cracks on the ferrite, resulting in the deterioration of product quality.

·Products should be soldered within the following allowable range indicated by the slanted line. The excessive soldering conditions may cause the corrosion of the electrode. When soldering is repeated, allowable time is the accumulated time.

DWG.No.	ASDIQ-SPE-108(00)	PAGE 17/19
---------	-------------------	---------------

## 6-2,Reflow soldering profile

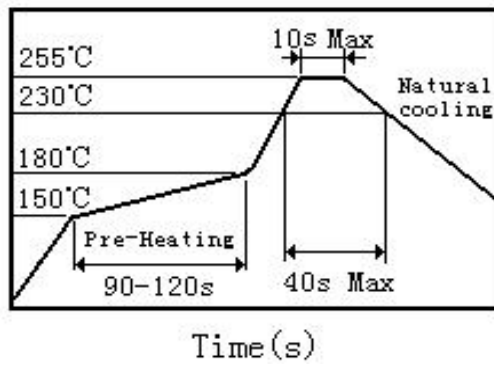

## 6-3,Iron soldering

Perform soldering at 350°C on 30W max.

Soldering Time: < 5S (Take care not to apply the tip of the soldering iron to the terminal electrodes)

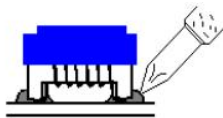

## (7)Cleaning

### 7-1,Cleaning Conditions

Cleaning temperature : 60°C max

Cleaning time: 5 minutes Max.

Ultrasonic output power: 200W max

## (8)Storage Requirements

### 8-1,Storage period

Products which inspected inductor company over 1 year ago should be examined and used, which can be confirmed with inspection No. marked on the container. Solder ability should be checked if this period is exceeded.

DWG.No.	ASDIQ-SPE-108(00)	PAGE 18/19
---------	-------------------	---------------

8-2,Storage conditions

- (1)Products should be storage in the warehouse on the following conditions:  
Temperature : -10~+40℃ Humidity: 30~70% relative humidity
- (2)Don't keep products in corrosive gases such as sulfur, chlorine gas or acid,oxidization of Electrodes resulting in poor solder ability.
- (3)Products should be stored on the palette for the prevention of the influence from humidity, dust and so on.
- (4)Products should be stored in the warehouse without heat shock, vibration, direct sunlight and so on.
- (5)Products should be stored under the airtight packaged condition.

(9)Usage Of ODS

For ODS listed below , we don't use in process.  
ODS: CCl4, HCFC, etc.

(10)Notes

- (1)Response to RoHS directive  
Our products are RoHS compliance.
- (2)This product specification guarantees the quality of our product as a single unit, Please make sure that your product has been evaluated and confirmed against your specifications when our product is mounted to your product.
- (3)We can't warrant against failure caused by any use of our product that deviates from the intended use as described in this product specification.
- (4)Do not touch wire with sharp objects such as tweezers to prevent wire breakage.

DWG.No.	ASDIQ-SPE-108(00)	PAGE 19/19
---------	-------------------	---------------

单击下面可查看定价，库存，交付和生命周期等信息

[>>ASDI](#)