

TO-126 Plastic-Encapsulate Transistors

2SC2688 TRANSISTOR (NPN)

FEATURES

- Color TV chroma out pupt circuits

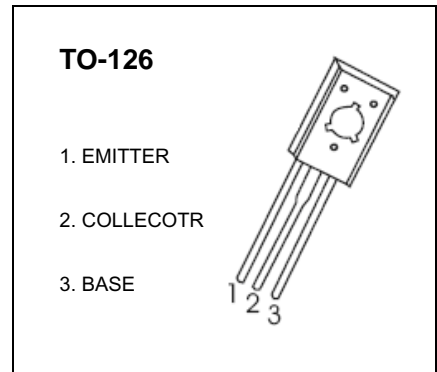

MARKING

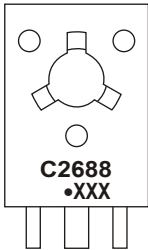

C2688=Device code
Solid dot= Green molding compound device, if none, the normal device
XXX=Code

Equivalent Circuit

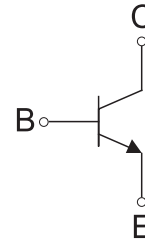

ORDERING INFORMATION

Part Number	Package	Packing Method	Pack Quantity
2SC2688	TO-126	Bulk	200pcs/Bag
2SC2688-TU	TO-126	Tube	60pcs/Tube

MAXIMUM RATINGS (Ta=25°C unless otherwise noted)

Symbol	Parameter	Value	Unit
V _{CB0}	Collector-Emitter Voltage	300	V
V _{CEO}	Collector-Emitter Voltage	300	V
V _{EBO}	Emitter-Base Voltage	5	V
I _C	Collector Current -Continuous	200	mA
P _c	Power Power dissipation	1.25	W
T _J	Junction Temperature	150	°C
T _{stg}	Storage Temperature	-55-150	°C

ELECTRICAL CHARACTERISTICS

$T_a=25^\circ\text{C}$ unless otherwise specified

Parameter	Symbol	Test conditions	Min	Typ	Max	Unit
Collector-base breakdown voltage	$V_{(BR)CBO}$	$I_C = 100\mu\text{A}, I_E = 0$	300			V
Collector-emitter breakdown voltage	$V_{(BR)CEO}$	$I_C = 1\text{mA}, I_B = 0$	300			V
Emitter-base breakdown voltage	$V_{(BR)EBO}$	$I_E = 100\mu\text{A}, I_C = 0$	5			V
Collector cut-off current	I_{CBO}	$V_{CB} = 200\text{V}, I_E = 0$			0.1	μA
Emitter cut-off current	I_{EBO}	$V_{EB} = 5\text{V}, I_C = 0$			0.1	μA
DC current gain	h_{FE}	$V_{CE} = 10\text{V}, I_C = 10\text{mA}$	40		250	
Collector-emitter saturation voltage	$V_{CE(sat)}$	$I_C = 50\text{mA}, I_B = 5\text{mA}$			0.5	V
Transition frequency	f_T	$V_{CE} = 30\text{V}, I_C = 10\text{mA}$	50			MHz

CLASSIFICATION OF h_{FE}

Rank	N	M	L	K
Range	40-80	60-120	100-200	160-250

Typical Characteristics

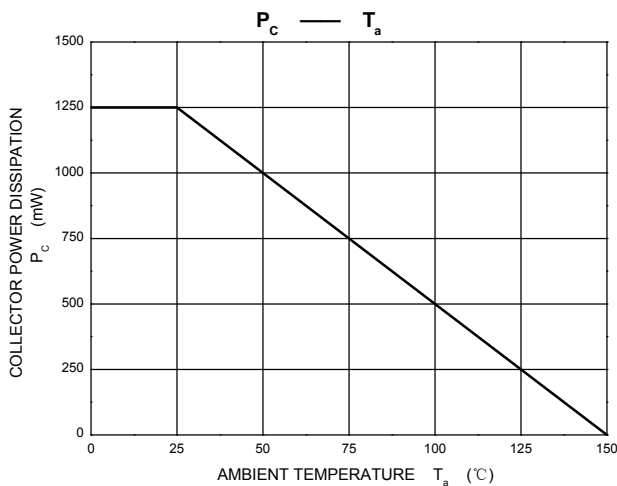
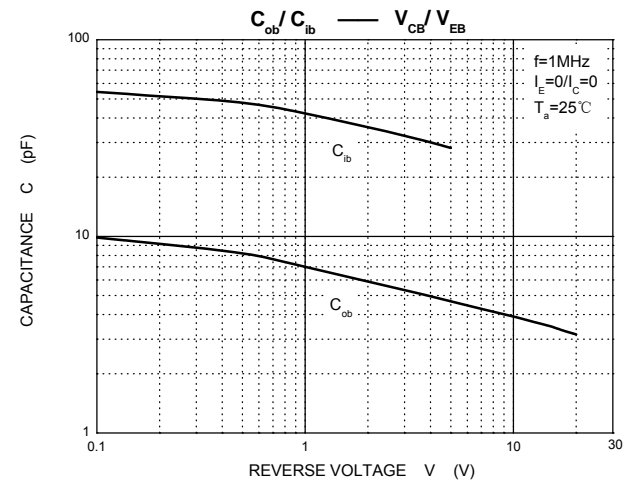
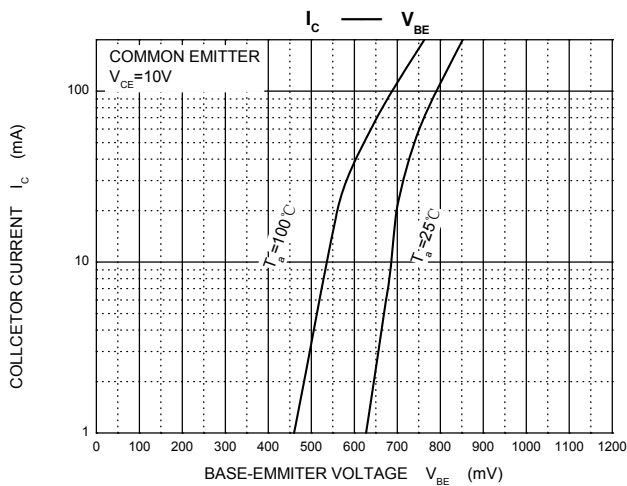
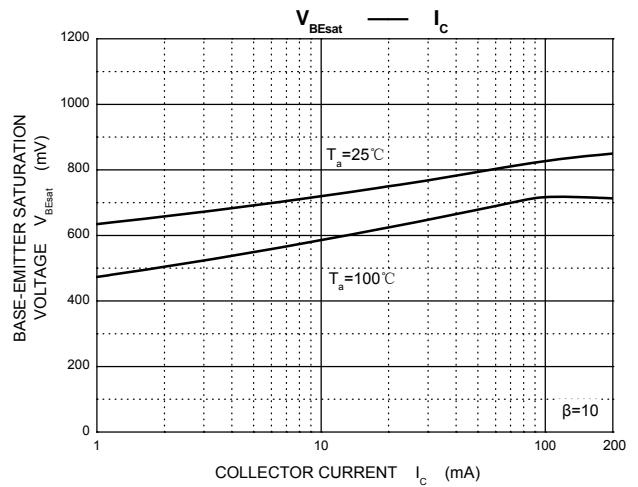
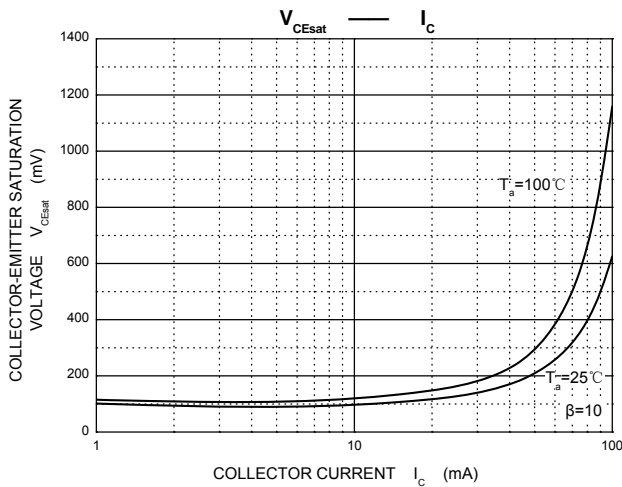
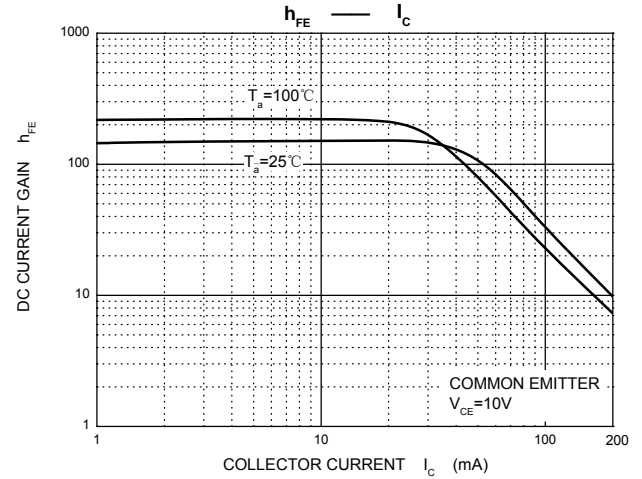
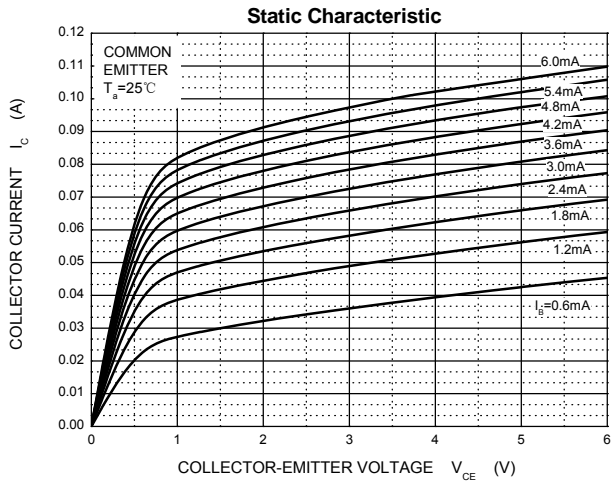

TO-126 Package Outline Dimensions



Symbol	Dimensions In Millimeters		Dimensions In Inches	
	Min	Max	Min	Max
A	2.500	2.900	0.098	0.114
A1	1.100	1.500	0.043	0.059
b	0.660	0.860	0.026	0.034
b1	1.170	1.370	0.046	0.054
c	0.450	0.600	0.018	0.024
D	7.400	7.800	0.291	0.307
E	10.600	11.000	0.417	0.433
e	2.290 TYP		0.090 TYP	
e1	4.480	4.680	0.176	0.184
h	0.000	0.300	0.000	0.012
L	15.300	15.700	0.602	0.618
L1	2.100	2.300	0.083	0.091
P	3.900	4.100	0.154	0.161
Φ	3.000	3.200	0.118	0.126

单击下面可查看定价，库存，交付和生命周期等信息

[>>JSCJ](#)