

Specification for Approval

Date: 2022/10/19
Customer : _____

Certificate of Green Partner

TAI-TECH P/N: HCB1005KV-600T20-HD
CUSTOMER P/N: _____

DESCRIPTION: _____

QUANTITY: _____ pcs
REMARK:

Customer Approval Feedback

--	--	--

西北臺慶科技股份有限公司
TAI-TECH Advanced Electronics Co., Ltd

西北臺慶科技股份有限公司
 TAI-TECH Advanced Electronics Co., Ltd
 Headquarter:
 NO.1 YOU 4TH ROAD, YOUTH INDUSTRIAL DISTRICT, YANG-MEI,
 TAO-YUAN HSIEN, TAIWAN, R.O.C.
 TEL: +886-3-4641148 FAX: +886-3-4643565
 http://www.tai-tech.com.tw
 E-mail: sales@tai-tech.com.tw

Sales Dep.

APPROVED	CHECKED
管哲頌 Eric Guan	蒯青榮

Office:
 深圳辦公室
 11BC, Building B Fortune Plaza, NO.7002, Shennan Avenue, Futian
 District Shenzhen
 TEL: +86-755-23972371 FAX: +86-755-23972340

臺慶精密電子(昆山)有限公司
 TAI-TECH ADVANCED ELECTRONICS(KUNSHAN) CO., LTD
 SHINWHA ROAD, KUNJIA HI-TECH INDUSTRIAL PARK, KUN-SHAN,
 JIANG-SU, CHINA
 TEL: +86-512-57619396 FAX: +86-512-57619688
 E-mail: sales@tai-tech.cn

R&D Center

APPROVED	CHECKED	DRAWN
鄧福興	浦冬生	王俞琴

慶邦電子元器件(泗洪)有限公司
 TAIPAQ ELECTRONICS (SIHONG) CO., LTD
 JIN SHA JIANG ROAD, CONOMIC DEVELOPMENT ZONE SIHONG,
 JIANGSU, CHINA.
 TEL: +86-527-88601191 FAX: +86-527-88601190
 E-mail: sales@taipaq.cn

High Current Ferrite Chip Bead(Lead Free) HCB1005KV-600T20-HD

1.Features

1. Monolithic inorganic material construction.
2. Closed magnetic circuit avoids crosstalk.
3. Suitable for reflow soldering.
4. Shapes and dimensions follow E.I.A. spec.
5. Available in various sizes.
6. Excellent solder ability and heat resistance.
7. High reliability. Reliability test meet AEC-Q200.
8. 100% Lead(Pb) & Halogen-Free and RoHS compliant.
9. Low DC resistance structure of electrode to prevent wasteful electric power consumption.
10. Operating Temperature: -55~+150°C (Including self-temperature rise)



2.Dimensions

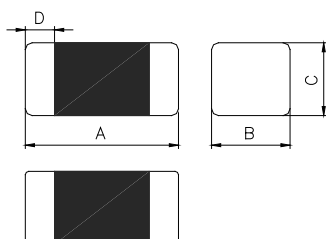

Chip Size	
A	1.00±0.10
B	0.50±0.10
C	0.50±0.10
D	0.25±0.10

Units: mm

3.Part Numbering

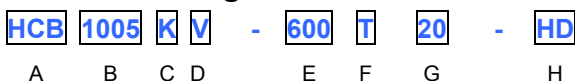

- A: Series
 - B: Dimension
 - C: Material
 - D: Category Code
 - E: Impedance
 - F: Packaging
 - G: Rated Current
 - H: Category Code
- L x W
Lead Free Material
V=Vehicle
600=60Ω
T=Taping and Reel, B=Bulk(Bags)
20=2000mA

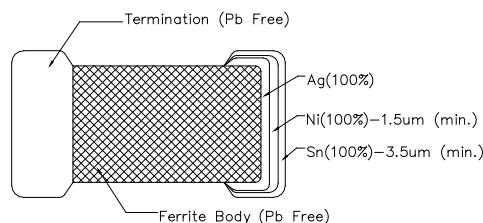

4.Specification

Tai-Tech Part Number	Impedance (Ω)	Test Frequency (Hz)	DC Resistance (Ω) max.	Rated Current (mA) max.
HCB1005KV-600T20-HD	60±25%	60mV/100M	0.10	2000

- Rated current: based on temperature rise test
- In compliance with EIA 595

■ Impedance-Frequency Characteristics

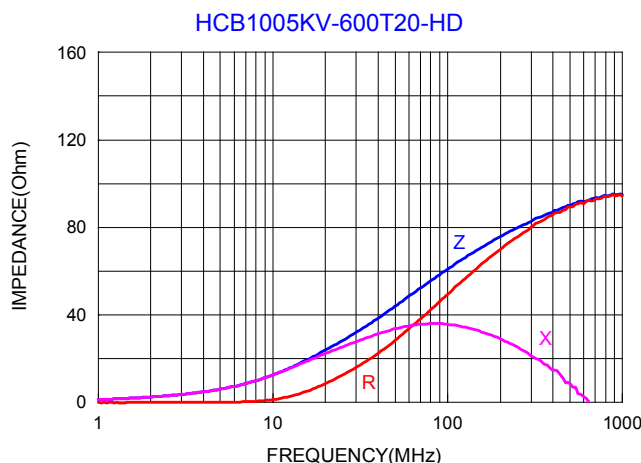

www.tai-tech.com.tw

5. Reliability and Test Condition

Item	Performance			Test Condition
Series No.	FCB	FCM	HCB	--
Operating Temperature	-55~+150℃ (Including self-temperature rise)			--
Transportation Storage Temperature	-55~+150℃ (on board)			For long storage conditions, please see the Application Notice
Impedance (Z)	Refer to standard electrical characteristics list			Agilent4291 Agilent E4991 Agilent4287 Agilent16192
DC Resistance				Agilent 4338
Rated Current				DC Power Supply Over Rated Current requirements, there will be some risk
Temperature Rise Test	Rated Current < 1A ΔT 20℃Max Rated Current ≧ 1A ΔT 40℃Max			1. Applied the allowed DC current. 2. Temperature measured by digital surface Thermometer.
High Temperature Exposure(Storage)	Appearance : No damage. Impedance : within±15% of initial value RDC : Within ±15% of initial value and shall not exceed the specification value			Preconditioning:Run through IR reflow for 3 times.(IPC/JEDEC J-STD-020E Classification Reflow Profiles Temperature : 150±2℃ Duration : 1000hrs Min. Measured at room temperature after placing for 24±2 hrs
Temperature Cycling				Preconditioning:Run through IR reflow for 3 times.(IPC/JEDEC J-STD-020E Classification Reflow Profiles Condition for 1 cycle Step1 : -55±2℃ 30min Min. Step2 : 150±2℃ transition time 1min MAX. Step3 : 150±2℃30min Min. (Bead) Step4 : Low temp. transition time 1min MAX. Number of cycles : 1000 Measured at room temperature after placing for 24±2 hrs
Biased Humidity (AEC-Q200)	Appearance : No damage. Impedance : within±15% of initial value RDC : Within ±15% of initial value and shall not exceed the specification value			Preconditioning:Run through IR reflow for 3 times.(IPC/JEDEC J-STD-020E Classification Reflow Profiles Humidity :85±3%RH. Temperature :85±2℃. Duration :1000 hrs Min. Measured at room temperature after placing for 24±2 hrs
High Temperature Operational Life				Preconditioning:Run through IR reflow for 3 times.(IPC/JEDEC J-STD-020E Classification Reflow Profiles Temperature : 150±2℃ Duration : 1000hrs Min. with 100% rated current. Measured at room temperature after placing for 24±2 hrs
External Visual	Appearance : No damage.			Inspect device construction, marking and workmanship. Electrical Test not required.
Physical Dimension	According to the product specification size measurement			According to the product specification size measurement
Resistance to Solvents	Appearance : No damage.			Add aqueous wash chemical - OKEM clean or equivalent.

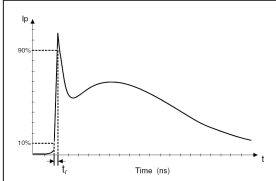
Item	Performance	Test Condition															
Mechanical Shock		Preconditioning:Run through IR reflow for 3 times.(IPC/JEDEC J-STD-020E Classification Reflow Profiles Test condition: <table border="1" data-bbox="1082 331 1415 465"> <thead> <tr> <th>Type</th> <th>Peak alue (g's)</th> <th>Normal duration (D) (ms)</th> <th>Wave form</th> <th>Velocity change (V)/ft/sec</th> </tr> </thead> <tbody> <tr> <td>SMD</td> <td>100</td> <td>6</td> <td>Half-sine</td> <td>12.3</td> </tr> <tr> <td>Lead</td> <td>100</td> <td>6</td> <td>Half-sine</td> <td>12.3</td> </tr> </tbody> </table> 3 shocks in each direction along 3 perpendicular axes (18 shocks).	Type	Peak alue (g's)	Normal duration (D) (ms)	Wave form	Velocity change (V)/ft/sec	SMD	100	6	Half-sine	12.3	Lead	100	6	Half-sine	12.3
Type	Peak alue (g's)	Normal duration (D) (ms)	Wave form	Velocity change (V)/ft/sec													
SMD	100	6	Half-sine	12.3													
Lead	100	6	Half-sine	12.3													
Vibration	Appearance : No damage. Impedance : within±15% of initial value RDC : Within ±15% of initial value and shall not exceed the specification value	Preconditioning:Run through IR reflow for 2 times.(IPC/JEDEC J-STD-020D Classification Reflow Profiles Oscillation Frequency: 10Hz ~ 2KHz ~ 10Hz for 20 minute Equipment : Vibration checker Total Amplitude:5g Testing Time : 12 hours(20 minutes, 12 cycles each of 3 orientations) °															
Resistance to Soldering Heat		Test condition :(ML-STD-202 Condition B) Number of heat cycles: 1 <table border="1" data-bbox="1082 779 1415 902"> <thead> <tr> <th>Temperature (°C)</th> <th>Time (s)</th> <th>Temperature ramp/immersion and emersion rate</th> </tr> </thead> <tbody> <tr> <td>260 ±5 (solder temp)</td> <td>10 ±1</td> <td>25mm/s±6mm/s</td> </tr> </tbody> </table> Depth: completely cover the termination	Temperature (°C)	Time (s)	Temperature ramp/immersion and emersion rate	260 ±5 (solder temp)	10 ±1	25mm/s±6mm/s									
Temperature (°C)	Time (s)	Temperature ramp/immersion and emersion rate															
260 ±5 (solder temp)	10 ±1	25mm/s±6mm/s															
Thermal shock	Appearance : No damage. Impedance : within±15% of initial value RDC : Within ±15% of initial value and shall not exceed the specification value	Preconditioning:Run through IR reflow for 3 times.(IPC/JEDEC J-STD-020E Classification Reflow Profiles Condition for 1 cycle Step1 : -55±2°C 15±1min Step2 : 150±2°C within 20 Sec. Step3 : 150±2°C 15±1min Number of cycles : 300 Measured at room temperature after placing for 24±2hrs															
ESD	Appearance : No damage.	 <p>Direct Contact and Air Discharge PASSIVE COMPONENT HBM ESD Discharge Waveform to a Coaxial Target Test method: AEC-Q200-002 Test mode : Contact Discharge Discharge level : 4 KV (Level: 2)</p>															
Solder ability	More than 95% of the terminal electrode should be covered with solder.	a.Method B, 4 hrs @155°C dry heat @235°C±5°C Test time:5 +0/-0.5 seconds. b. Method D category 3. (steam aging 8hours ± 15 min)@ 260°C±5°C Test time: 30 +0/-0.5 seconds.															
Electrical Characterization	Refer Specification for Approval	Summary to show Min, Max, Mean and Standard deviation															
Flammability	Electrical Test not required.	V-0 or V-1 are acceptable.															

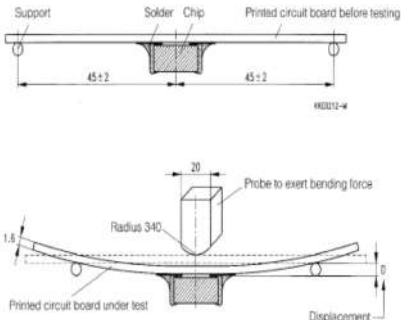
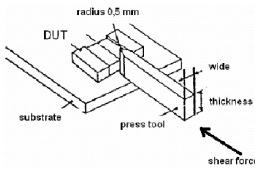
Item	Performance	Test Condition
Board Flex	Appearance : No damage.	 <p>Preconditioning: Run through IR reflow for 3 times. (IPC/JEDEC J-STD-020E Classification Reflow Profiles Place the 100mm X 40mm board into a fixture similar to the one shown in below Figure with the component facing down. The apparatus shall consist of mechanical means to apply a force which will bend the board (D) x = 2 mm minimum. The duration of the applied forces shall be 60 (+ 5) sec. The force is to be applied only once to the board.</p>
Terminal strength	Appearance : No damage.	 <p>AEC-Q200 , TAI-TECH SPEC. 5N</p>

****Derating Curve**

For the ferrite chip bead which withstanding current over 1.5A, as the operating temperature over 110°C, the derating current information is necessary to consider with. For the detail derating of current, please refer to the Derated Current vs. Operating Temperature curve.

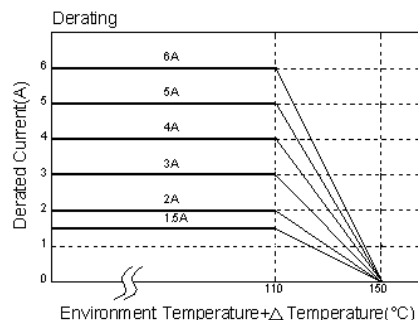

6.Soldering and Mounting

6-1. Recommended PC Board Pattern

Series	Type	Chip Size				Land Patterns For Reflow Soldering		
		A(mm)	B(mm)	C(mm)	D(mm)	E(mm)	F(mm)	G(mm)
	1005	1.0±0.10	0.50±0.10	0.50±0.10	0.25±0.10	0.50	0.40	0.60
FCB	1606	1.6±0.15	0.80±0.15	0.60±0.15	0.30±0.20	0.80	0.85	0.95
FCM	1608	1.6±0.15	0.80±0.15	0.80±0.15	0.30±0.20	0.80	0.85	0.95
HCB	2012	2.0±0.20	1.25±0.20	0.85±0.20	0.50±0.30	1.05	1.00	1.45
GHB		2.0±0.20	1.25±0.20	1.25±0.20	0.50±0.30			
FCI	3216	3.2±0.20	1.60±0.20	1.10±0.20	0.50±0.30	1.05	2.20	1.80
FHI	3225	3.2±0.20	2.50±0.20	1.30±0.20	0.50±0.30	1.05	2.20	2.70
FCH	4516	4.5±0.20	1.60±0.20	1.60±0.20	0.50±0.30	1.05	3.30	1.80
HCI	4532	4.5±0.20	3.20±0.20	1.50±0.20	0.50±0.30	1.05	3.30	3.40

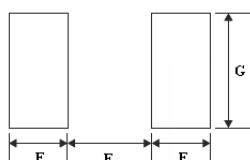
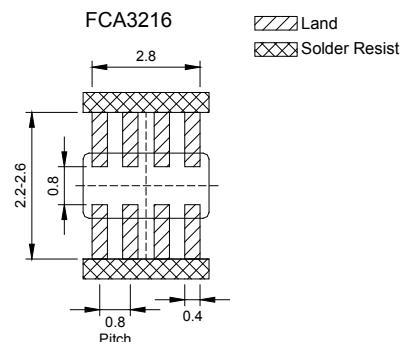

PC board should be designed so that products can prevent damage from mechanical stress when warping the board.

6-2. Soldering

Mildly activated rosin fluxes are preferred. TAI-TECH terminations are suitable for re-flow soldering systems. If hand soldering cannot be avoided, the preferred technique is the utilization of hot air soldering tools.

6-2.1 IR Soldering Reflow:

Recommended temperature profiles for lead free re-flow soldering in Figure 1. Table 1.1&1.2 (J-STD-020E)

6-2.2 Soldering Iron:

Products attachment with a soldering iron is discouraged due to the inherent process control limitations. In the event that a soldering iron must be employed the following precautions are recommended. (Figure 2.)

- Preheat circuit and products to 150°C
- Never contact the ceramic with the iron tip
- Use a 20 watt soldering iron with tip diameter of 1.0mm
- 350°C tip temperature (max)
- 1.0mm tip diameter (max)
- Limit soldering time to 4-5sec.

Fig.1 IR Soldering Reflow

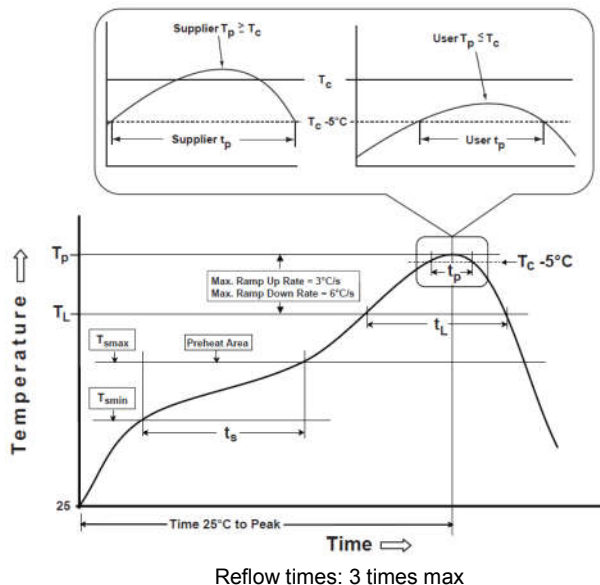

Fig.2 Iron soldering temperature profiles

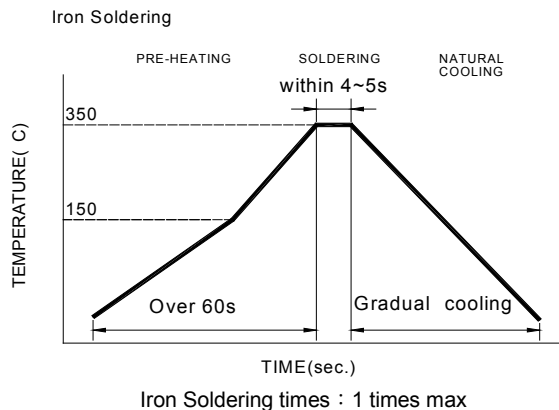

Table (1.1): Reflow Profiles

Profile Type:	Pb-Free Assembly
Preheat	
-Temperature Min(T_{smin})	150°C
-Temperature Max(T_{smax})	200°C
-Time(t_s)from(T_{smin} to T_{smax})	60-120seconds
Ramp-up rate(T_L to T_p)	3°C/second max.
Liquidus temperature(T_L)	217°C
Time(t_L)maintained above T_L	60-150 seconds
Classification temperature(T_c)	See Table (1.2)
Time(t_p) at $T_c - 5^\circ C$ (T_p should be equal to or less than T_c .)	< 30 seconds
Ramp-down rate(T_p to T_L)	6°C /second max.
Time 25°C to peak temperature	8 minutes max.

Tp: maximum peak package body temperature, **Tc**: the classification temperature.
 For user (customer) **Tp** should be equal to or less than **Tc**.

Table (1.2) Package Thickness/Volume and Classification Temperature (T_c)

	Package Thickness	Volume mm ³ <350	Volume mm ³ 350-2000	Volume mm ³ >2000
PB-Free Assembly	<1.6mm	260°C	260°C	260°C
	1.6-2.5mm	260°C	250°C	245°C
	≥2.5mm	250°C	245°C	245°C

Reflow is referred to standard IPC/JEDEC J-STD-020E ◦

6-2.3 Solder Volume:

Accordingly increasing the solder volume, the mechanical stress to product is also increased. Exceeding solder volume may cause the failure of mechanical or electrical performance. Solder shall be used not to be exceed as shown in right side:

Minimum fillet height = soldering thickness + 25% product height

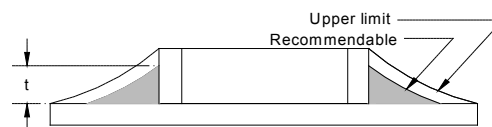

7. Packaging Information

7-1. Reel Dimension

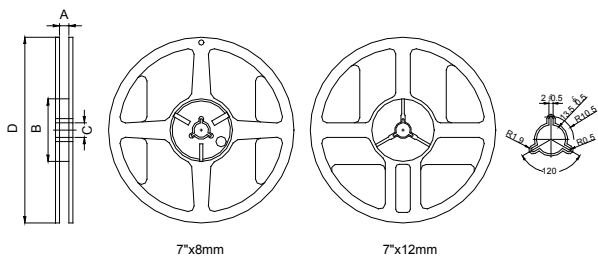

Type	A(mm)	B(mm)	C(mm)	D(mm)
7"x8mm	9.0±0.5	60±2	13.5±0.5	178±2
7"x12mm	13.5±0.5	60±2	13.5±0.5	178±2

7-2.1 Tape Dimension / 8mm

Material of taping is paper

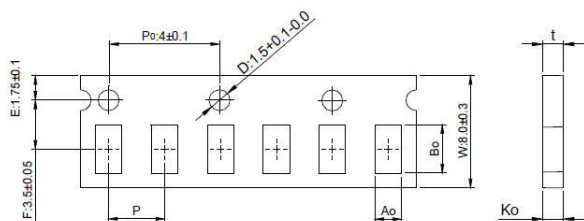

Size	Bo(mm)	Ao(mm)	Ko(mm)	P(mm)	t(mm)
100505	1.12±0.03	0.62±0.03	0.60±0.03	2.0±0.05	0.60±0.03

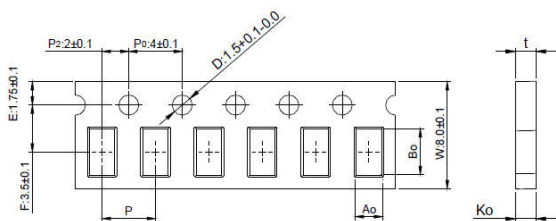

Size	Bo(mm)	Ao(mm)	Ko(mm)	P(mm)	t(mm)
160806	1.78±0.03	0.97±0.03	0.75±0.03	4.0±0.10	0.75±0.03
160808	1.80±0.05	0.96±0.05/-0.03	0.95±0.05	4.0±0.10	0.95±0.05
201209	2.10±0.05	1.30±0.05	0.95±0.05	4.0±0.10	0.95±0.05

Material of taping is plastic

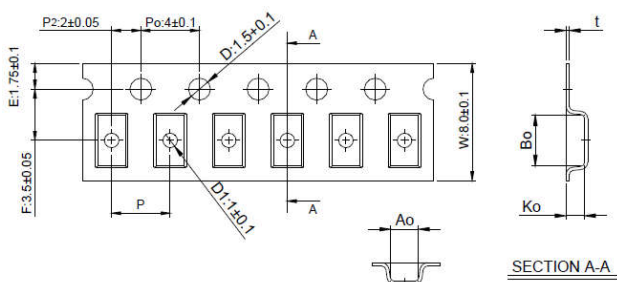

Size	Bo(mm)	Ao(mm)	Ko(mm)	P(mm)	t(mm)	D1(mm)
201212	2.10±0.10	1.28±0.10	1.28±0.10	4.0±0.10	0.22±0.05	1.0±0.10
321611	3.35±0.10	1.75±0.10	1.25±0.10	4.0±0.10	0.23±0.05	1.0±0.10
322513	3.42±0.10	2.77±0.10	1.55±0.10	4.0±0.10	0.22±0.05	1.0±0.10
321609	3.40±0.10	1.77±0.10	1.04±0.10	4.0±0.10	0.22±0.05	1.0±0.10

7-2.2 Tape Dimension / 12mm

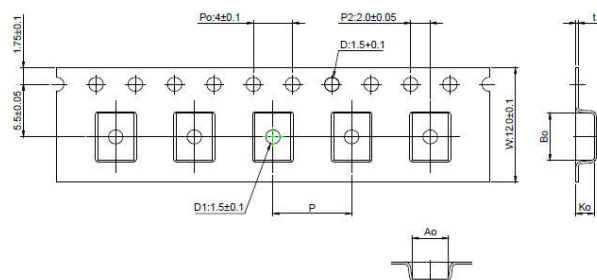

Size	Bo(mm)	Ao(mm)	Ko(mm)	P(mm)	t(mm)	D1(mm)
451616	4.70±0.10	1.75±0.10	1.75±0.10	4.0±0.10	0.24±0.05	1.5±0.10
453215	4.70±0.10	3.45±0.10	1.60±0.10	8.0±0.10	0.24±0.05	1.5±0.10

7-3. Packaging Quantity

Chip Size	453215	451616	322513	321611	321609	201212	201209	160808	160806	100505
Chip / Reel	1000	2000	2500	3000	3000	2000	4000	4000	4000	10000
Inner box	4000	8000	12500	15000	15000	10000	20000	20000	20000	50000
Middle box	20000	40000	62500	75000	75000	50000	100000	100000	100000	250000
Carton	40000	80000	125000	150000	150000	100000	200000	200000	200000	500000

7-4. Tearing Off Force

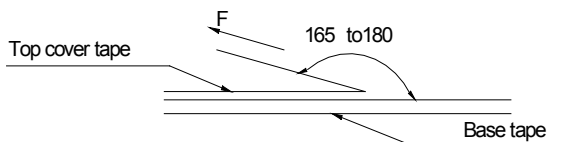

The force for tearing off cover tape is 15 to 60 grams in the arrow direction under the following conditions.

Room Temp. (°C)	Room Humidity (%)	Room atm (hPa)	Tearing Speed mm/min
5~35	45~85	860~1060	300

Application Notice

- Storage Conditions(component level)
 - To maintain the solderability of terminal electrodes:
 1. TAI-TECH products meet IPC/JEDEC J-STD-020E standard-MSL, level 1.
 2. Temperature and humidity conditions: Less than 40°C and 60% RH.
 3. Recommended products should be used within 12 months from the time of delivery.
 4. The packaging material should be kept where no chlorine or sulfur exists in the air.
- Transportation
 1. Products should be handled with care to avoid damage or contamination from perspiration and skin oils.
 2. The use of tweezers or vacuum pick up is strongly recommended for individual components.
 3. Bulk handling should ensure that abrasion and mechanical shock are minimized.



測試報告 Test Report

號碼(No.): ETR21C00682 日期(Date): 10-Dec-2021 頁數(Page): 1 of 15

西北臺慶科技股份有限公司 (TAI-TECH ADVANCED ELECTRONICS CO., LTD.)
臺慶精密電子 (昆山) 有限公司 (TAI-TECH ADVANCED ELECTRONICS (KUN-SHAN) CO., LTD.)
慶邦電子元器件 (泗洪) 有限公司 (TAIPAQ ELECTRONICS (SI-HONG) CO., LTD.)
桃園市楊梅區幼獅工業區幼四路1號 (NO. 1, YOU 4TH ROAD, YOUTH INDUSTRIAL DISTRICT, YANG-MEI, TAO-YUAN CITY, TAIWAN R. O. C.)
江蘇省昆山市蓬朗昆嘉高科技工業區郭澤路 (GUO-ZE ROAD, KUNJIA HI-TECH INDUSTRIAL PARK, KUN-SHAN, JIANG-SU, CHINA)
中國·江蘇省·宿遷市·泗洪縣·經濟開發區杭州路南側·建設北路東側 (THE SOUTH HANGZHOU ROAD AND THE EAST JIANSHE ROAD·ECONOMIC DEVELOPMENT ZONE·SIHONG COUNTY·SUQIANCITY·JIANGSU PROVINCE·P,R·CHINA)

以下測試樣品係由申請廠商所提供及確認 (The following sample(s) was/were submitted and identified by/on behalf of the applicant as) :

樣品名稱(Sample Name) : FERRITE CHIP BEAD、FERRITE CHIP INDUCTOR、ARRAY、MCF、MCM、YMV SERIES
樣品型號(Style/Item No.) : FERRITE CHIP BEAD、FERRITE CHIP INDUCTOR、ARRAY、MCF、MCM、YMV SERIES

=====
收件日(Sample Receiving Date) : 03-Dec-2021
測試期間(Testing Period) : 03-Dec-2021 to 10-Dec-2021

測試需求(Test Requested) : 依據客戶要求進行測試，測試項目請參閱測試結果表格。(Testing item(s) is/are specified by client. Please refer to result table for testing item(s).)

測試結果(Test Results) : 請參閱下一頁 (Please refer to following pages.)

Troy Chang, Manager, Test
Signed for and on behalf of
SGS TAIWAN LTD.
Chemical Laboratory - Taipei



PIN CODE: 14A3CBB3

This document is issued by the Company subject to its General Conditions of Service printed overleaf, available on request or accessible at <https://www.sgs.com.tw/terms-of-service> and, for electronic format documents, subject to Terms and Conditions for Electronic Documents at <https://www.sgs.com.tw/terms-of-service>. Attention is drawn to the limitation of liability, indemnification and jurisdiction issues defined therein. Any holder of this document is advised that information contained hereon reflects the Company's findings at the time of its intervention only and within the limits of client's instruction, if any. The Company's sole responsibility is to its Client and this document does not exonerate parties to a transaction from exercising all their rights and obligations under the transaction documents. This document cannot be reproduced, except in full, without prior written approval of the Company. Any unauthorized alteration, forgery or falsification of the content or appearance of this document is unlawful and offenders may be prosecuted to the fullest extent of the law. Unless otherwise stated the results shown in this test report refer only to the sample(s) tested.

SGS Taiwan Ltd. 台灣檢驗科技股份有限公司 | 新北市五股區新北產業園區五權七路 25 號 t+886(02)2299 3939 f+886(02)2299 3237
25, Wu Chyuan 7th Road, New Taipei Industrial Park, Wu Ku District, New Taipei City, Taiwan

Member of the SGS Group



測試報告

Test Report

號碼(No.): ETR21C00682

日期(Date): 10-Dec-2021

頁數(Page): 2 of 15

西北臺慶科技股份有限公司 (TAI-TECH ADVANCED ELECTRONICS CO., LTD.)

臺慶精密電子(昆山)有限公司 (TAI-TECH ADVANCED ELECTRONICS (KUN-SHAN) CO., LTD.)

慶邦電子元器件(泗洪)有限公司 (TAIPAQ ELECTRONICS (SI-HONG) CO., LTD.)

桃園市楊梅區幼獅工業區幼四路1號 (NO. 1, YOU 4TH ROAD, YOUTH INDUSTRIAL DISTRICT, YANG-MEI, TAO-YUAN CITY, TAIWAN R. O. C.)

江蘇省昆山市蓬朗昆嘉高科技工業區郭澤路 (GUO-ZE ROAD, KUNJIA HI-TECH INDUSTRIAL PARK, KUN-SHAN, JIANG-SU, CHINA)

中國·江蘇省·宿遷市·泗洪縣·經濟開發區杭州路南側·建設北路東側 (THE SOUTH HANGZHOU ROAD AND THE EAST JIANSHE ROAD·ECONOMIC DEVELOPMENT ZONE·SIHONG COUNTY·SUQIANCITY·JIANGSU PROVINCE·P,R·CHINA)

測試部位敘述 (Test Part Description)

No.1 : 整體混測 (MIXED ALL PARTS)

測試結果 (Test Results)

測試項目 (Test Items)	測試方法 (Method)	單位 (Unit)	MDL	結果 (Result)
				No.1
鎘 (Cd) (Cadmium (Cd)) (CAS No.: 7440-43-9)	參考IEC 62321-5: 2013 · 以感應耦合電漿發射光譜儀分析。(With reference to IEC 62321-5: 2013, analysis was performed by ICP-OES.)	mg/kg	2	n.d.
鉛 (Pb) (Lead (Pb)) (CAS No.: 7439-92-1)	參考IEC 62321-5: 2013 · 以感應耦合電漿發射光譜儀分析。(With reference to IEC 62321-5: 2013, analysis was performed by ICP-OES.)	mg/kg	2	n.d.
汞 (Hg) (Mercury (Hg)) (CAS No.: 7439-97-6)	參考IEC 62321-4: 2013+ AMD1: 2017 · 以感應耦合電漿發射光譜儀分析。(With reference to IEC 62321-4: 2013+ AMD1: 2017, analysis was performed by ICP-OES.)	mg/kg	2	n.d.
六價鉻 Cr(VI) (Hexavalent Chromium Cr(VI)) (CAS No.: 18540-29-9)	參考IEC 62321-7-2: 2017 · 以紫外光-可見光分光光度計分析。(With reference to IEC 62321-7-2: 2017, analysis was performed by UV-VIS.)	mg/kg	8	n.d.

This document is issued by the Company subject to its General Conditions of Service printed overleaf, available on request or accessible at <https://www.sgs.com.tw/terms-of-service> and, for electronic format documents, subject to Terms and Conditions for Electronic Documents at <https://www.sgs.com.tw/terms-of-service>. Attention is drawn to the limitation of liability, indemnification and jurisdiction issues defined therein. Any holder of this document is advised that information contained hereon reflects the Company's findings at the time of its intervention only and within the limits of client's instruction, if any. The Company's sole responsibility is to its Client and this document does not exonerate parties to a transaction from exercising all their rights and obligations under the transaction documents. This document cannot be reproduced, except in full, without prior written approval of the Company. Any unauthorized alteration, forgery or falsification of the content or appearance of this document is unlawful and offenders may be prosecuted to the fullest extent of the law. Unless otherwise stated the results shown in this test report refer only to the sample(s) tested.



測試報告

Test Report

號碼(No.): ETR21C00682

日期(Date): 10-Dec-2021

頁數(Page): 3 of 15

西北臺慶科技股份有限公司 (TAI-TECH ADVANCED ELECTRONICS CO., LTD.)

臺慶精密電子 (昆山) 有限公司 (TAI-TECH ADVANCED ELECTRONICS (KUN-SHAN) CO., LTD.)

慶邦電子元器件 (泗洪) 有限公司 (TAIPAQ ELECTRONICS (SI-HONG) CO., LTD.)

桃園市楊梅區幼獅工業區幼四路1號 (NO. 1, YOU 4TH ROAD, YOUTH INDUSTRIAL DISTRICT, YANG-MEI, TAO-YUAN CITY, TAIWAN R. O. C.)

江蘇省昆山市鐘朗昆嘉高科技工業區郭澤路 (GUO-ZE ROAD, KUNJIA HI-TECH INDUSTRIAL PARK, KUN-SHAN, JIANG-SU, CHINA)

中國 · 江蘇省 · 宿遷市 · 泗洪縣 · 經濟開發區杭州路南側 · 建設北路東側 (THE SOUTH HANGZHOU ROAD AND THE EAST JIANSHE ROAD · ECONOMIC DEVELOPMENT ZONE · SIHONG COUNTY · SUQIANCITY · JIANGSU PROVINCE · P,R · CHINA)

測試項目 (Test Items)	測試方法 (Method)	單位 (Unit)	MDL	結果 (Result)
				No.1
一溴聯苯 (Monobromobiphenyl)	參考IEC 62321-6: 2015 · 以氣相層析儀/質譜儀分析 · (With reference to IEC 62321-6: 2015, analysis was performed by GC/MS.)	mg/kg	5	n.d.
二溴聯苯 (Dibromobiphenyl)		mg/kg	5	n.d.
三溴聯苯 (Tribromobiphenyl)		mg/kg	5	n.d.
四溴聯苯 (Tetrabromobiphenyl)		mg/kg	5	n.d.
五溴聯苯 (Pentabromobiphenyl)		mg/kg	5	n.d.
六溴聯苯 (Hexabromobiphenyl)		mg/kg	5	n.d.
七溴聯苯 (Heptabromobiphenyl)		mg/kg	5	n.d.
八溴聯苯 (Octabromobiphenyl)		mg/kg	5	n.d.
九溴聯苯 (Nonabromobiphenyl)		mg/kg	5	n.d.
十溴聯苯 (Decabromobiphenyl)		mg/kg	5	n.d.
多溴聯苯總和 (Sum of PBBs)		mg/kg	-	n.d.
一溴聯苯醚 (Monobromodiphenyl ether)		mg/kg	5	n.d.
二溴聯苯醚 (Dibromodiphenyl ether)		mg/kg	5	n.d.
三溴聯苯醚 (Tribromodiphenyl ether)		mg/kg	5	n.d.
四溴聯苯醚 (Tetrabromodiphenyl ether)		mg/kg	5	n.d.
五溴聯苯醚 (Pentabromodiphenyl ether)		mg/kg	5	n.d.
六溴聯苯醚 (Hexabromodiphenyl ether)		mg/kg	5	n.d.
七溴聯苯醚 (Heptabromodiphenyl ether)		mg/kg	5	n.d.
八溴聯苯醚 (Octabromodiphenyl ether)		mg/kg	5	n.d.
九溴聯苯醚 (Nonabromodiphenyl ether)		mg/kg	5	n.d.
十溴聯苯醚 (Decabromodiphenyl ether)		mg/kg	5	n.d.
多溴聯苯醚總和 (Sum of PBDEs)		mg/kg	-	n.d.

This document is issued by the Company subject to its General Conditions of Service printed overleaf, available on request or accessible at <https://www.sgs.com.tw/terms-of-service> and, for electronic format documents, subject to Terms and Conditions for Electronic Documents at <https://www.sgs.com.tw/terms-of-service>. Attention is drawn to the limitation of liability, indemnification and jurisdiction issues defined therein. Any holder of this document is advised that information contained hereon reflects the Company's findings at the time of its intervention only and within the limits of client's instruction, if any. The Company's sole responsibility is to its Client and this document does not exonerate parties to a transaction from exercising all their rights and obligations under the transaction documents. This document cannot be reproduced, except in full, without prior written approval of the Company. Any unauthorized alteration, forgery or falsification of the content or appearance of this document is unlawful and offenders may be prosecuted to the fullest extent of the law. Unless otherwise stated the results shown in this test report refer only to the sample(s) tested.



測試報告

Test Report

號碼(No.): ETR21C00682

日期(Date): 10-Dec-2021

頁數(Page): 4 of 15

西北臺慶科技股份有限公司 (TAI-TECH ADVANCED ELECTRONICS CO., LTD.)

臺慶精密電子 (昆山) 有限公司 (TAI-TECH ADVANCED ELECTRONICS (KUN-SHAN) CO., LTD.)

慶邦電子元器件 (泗洪) 有限公司 (TAIPAQ ELECTRONICS (SI-HONG) CO., LTD.)

桃園市楊梅區幼獅工業區幼四路1號 (NO. 1, YOU 4TH ROAD, YOUTH INDUSTRIAL DISTRICT, YANG-MEI, TAO-YUAN CITY, TAIWAN R. O. C.)

江蘇省昆山市蓬朗昆嘉高科技工業區郭澤路 (GUO-ZE ROAD, KUNJIA HI-TECH INDUSTRIAL PARK, KUN-SHAN, JIANG-SU, CHINA)

中國 · 江蘇省 · 宿遷市 · 泗洪縣 · 經濟開發區杭州路南側 · 建設北路東側 (THE SOUTH HANGZHOU ROAD AND THE EAST JIANSHE ROAD · ECONOMIC DEVELOPMENT ZONE · SIHONG COUNTY · SUQIANCITY · JIANGSU PROVINCE · P.R · CHINA)

測試項目 (Test Items)	測試方法 (Method)	單位 (Unit)	MDL	結果 (Result)
				No.1
鄰苯二甲酸丁苯甲酯 (BBP) (Butyl benzyl phthalate (BBP)) (CAS No.: 85-68-7)	參考IEC 62321-8: 2017 · 以氣相層析儀/質譜儀分析 · (With reference to IEC 62321-8: 2017, analysis was performed by GC/MS.)	mg/kg	50	n.d.
鄰苯二甲酸二丁酯 (DBP) (Dibutyl phthalate (DBP)) (CAS No.: 84-74-2)		mg/kg	50	n.d.
鄰苯二甲酸二(2-乙基己基)酯 (DEHP) (Di-(2-ethylhexyl) phthalate (DEHP)) (CAS No.: 117-81-7)		mg/kg	50	n.d.
鄰苯二甲酸二異丁酯 (DIBP) (Diisobutyl phthalate (DIBP)) (CAS No.: 84-69-5)		mg/kg	50	n.d.
鄰苯二甲酸二異癸酯 (DIDP) (Diisodecyl phthalate (DIDP)) (CAS No.: 26761-40-0, 68515-49-1)		mg/kg	50	n.d.
鄰苯二甲酸二異壬酯 (DINP) (Diisononyl phthalate (DINP)) (CAS No.: 28553-12-0, 68515-48-0)		mg/kg	50	n.d.
鄰苯二甲酸二正辛酯 (DNOP) (Di-n-octyl phthalate (DNOP)) (CAS No.: 117-84-0)		mg/kg	50	n.d.
鄰苯二甲酸二正戊酯 (DNPP) (Di-n-pentyl phthalate (DNPP)) (CAS No.: 131-18-0)		mg/kg	50	n.d.
鄰苯二甲酸二正己酯 (DNHP) (Di-n-hexyl phthalate (DNHP)) (CAS No.: 84-75-3)		mg/kg	50	n.d.

This document is issued by the Company subject to its General Conditions of Service printed overleaf, available on request or accessible at <https://www.sgs.com.tw/terms-of-service> and, for electronic format documents, subject to Terms and Conditions for Electronic Documents at <https://www.sgs.com.tw/terms-of-service>. Attention is drawn to the limitation of liability, indemnification and jurisdiction issues defined therein. Any holder of this document is advised that information contained hereon reflects the Company's findings at the time of its intervention only and within the limits of client's instruction, if any. The Company's sole responsibility is to its Client and this document does not exonerate parties to a transaction from exercising all their rights and obligations under the transaction documents. This document cannot be reproduced, except in full, without prior written approval of the Company. Any unauthorized alteration, forgery or falsification of the content or appearance of this document is unlawful and offenders may be prosecuted to the fullest extent of the law. Unless otherwise stated the results shown in this test report refer only to the sample(s) tested.



測試報告

Test Report

號碼(No.): ETR21C00682

日期(Date): 10-Dec-2021

頁數(Page): 5 of 15

西北臺慶科技股份有限公司 (TAI-TECH ADVANCED ELECTRONICS CO., LTD.)

臺慶精密電子 (昆山) 有限公司 (TAI-TECH ADVANCED ELECTRONICS (KUN-SHAN) CO., LTD.)

慶邦電子元器件 (泗洪) 有限公司 (TAIPAQ ELECTRONICS (SI-HONG) CO., LTD.)

桃園市楊梅區幼獅工業區幼四路1號 (NO. 1, YOU 4TH ROAD, YOUTH INDUSTRIAL DISTRICT, YANG-MEI, TAO-YUAN CITY, TAIWAN R. O. C.)

江蘇省昆山市蓬朗區嘉高科技工業區郭澤路 (GUO-ZE ROAD, KUNJIA HI-TECH INDUSTRIAL PARK, KUN-SHAN, JIANG-SU, CHINA)

中國 · 江蘇省 · 宿遷市 · 泗洪縣 · 經濟開發區杭州路南側 · 建設北路東側 (THE SOUTH HANGZHOU ROAD AND THE EAST JIANSHE ROAD · ECONOMIC DEVELOPMENT ZONE · SIHONG COUNTY · SUQIANCITY · JIANGSU PROVINCE · P.R · CHINA)

測試項目 (Test Items)	測試方法 (Method)	單位 (Unit)	MDL	結果 (Result)
				No.1
六溴環十二烷及所有主要被辨別出的異構物(HBCDD) (α- HBCDD, β- HBCDD, γ- HBCDD) (Hexabromocyclododecane (HBCDD) and all major diastereoisomers identified (α- HBCDD, β- HBCDD, γ- HBCDD)) (CAS No.: 25637-99-4, 3194-55-6 (134237-51-7, 134237-50-6, 134237-52-8))	參考IEC 62321-9: 2021 · 以氣相層析儀/質譜儀分析 · (With reference to IEC 62321-9: 2021, analysis was performed by GC/MS.)	mg/kg	20	n.d.
氟 (F) (Fluorine (F)) (CAS No.: 14762-94-8)	參考BS EN 14582: 2016 · 以離子層析儀分析 · (With reference to BS EN 14582: 2016, analysis was performed by IC.)	mg/kg	50	n.d.
氯 (Cl) (Chlorine (Cl)) (CAS No.: 22537-15-1)		mg/kg	50	n.d.
溴 (Br) (Bromine (Br)) (CAS No.: 10097-32-2)		mg/kg	50	n.d.
碘 (I) (Iodine (I)) (CAS No.: 14362-44-8)		mg/kg	50	n.d.
全氟辛烷磺酸及其鹽類 (PFOS and its salts) (CAS No.: 1763-23-1 and its salts)	參考CEN/TS 15968: 2010 · 以液相層析串聯質譜儀分析 · (With reference to CEN/TS 15968: 2010, analysis was performed by LC/MS/MS.)	mg/kg	0.01	n.d.
全氟辛酸及其鹽類 (PFOA and its salts) (CAS No.: 335-67-1 and its salts)	參考CEN/TS 15968: 2010 · 以液相層析串聯質譜儀分析 · (With reference to CEN/TS 15968: 2010, analysis was performed by LC/MS/MS.)	mg/kg	0.01	n.d.

This document is issued by the Company subject to its General Conditions of Service printed overleaf, available on request or accessible at <https://www.sgs.com.tw/terms-of-service> and, for electronic format documents, subject to Terms and Conditions for Electronic Documents at <https://www.sgs.com.tw/terms-of-service>. Attention is drawn to the limitation of liability, indemnification and jurisdiction issues defined therein. Any holder of this document is advised that information contained hereon reflects the Company's findings at the time of its intervention only and within the limits of client's instruction, if any. The Company's sole responsibility is to its Client and this document does not exonerate parties to a transaction from exercising all their rights and obligations under the transaction documents. This document cannot be reproduced, except in full, without prior written approval of the Company. Any unauthorized alteration, forgery or falsification of the content or appearance of this document is unlawful and offenders may be prosecuted to the fullest extent of the law. Unless otherwise stated the results shown in this test report refer only to the sample(s) tested.

SGS Taiwan Ltd. 台灣檢驗科技股份有限公司

新北市五股區新北產業園區五權七路 25 號 t+886(02)2299 3939 f+886(02)2299 3237
25, Wu Chyuan 7th Road, New Taipei Industrial Park, Wu Ku District, New Taipei City, Taiwan

Member of the SGS Group



測試報告

Test Report

號碼(No.): ETR21C00682

日期(Date): 10-Dec-2021

頁數(Page): 6 of 15

西北臺慶科技股份有限公司 (TAI-TECH ADVANCED ELECTRONICS CO., LTD.)

臺慶精密電子(昆山)有限公司 (TAI-TECH ADVANCED ELECTRONICS (KUN-SHAN) CO., LTD.)

慶邦電子元器件(泗洪)有限公司 (TAIPAQ ELECTRONICS (SI-HONG) CO., LTD.)

桃園市楊梅區幼獅工業區幼四路1號 (NO. 1, YOU 4TH ROAD, YOUTH INDUSTRIAL DISTRICT, YANG-MEI, TAO-YUAN CITY, TAIWAN R. O. C.)

江蘇省昆山市鐘朗昆嘉高科技工業區郭澤路 (GUO-ZE ROAD, KUNJIA HI-TECH INDUSTRIAL PARK, KUN-SHAN, JIANG-SU, CHINA)

中國·江蘇省·宿遷市·泗洪縣·經濟開發區杭州路南側·建設北路東側 (THE SOUTH HANGZHOU ROAD AND THE EAST JIANSHE ROAD · ECONOMIC DEVELOPMENT ZONE · SIHONG COUNTY · SUQIANCITY · JIANGSU PROVINCE · P.R · CHINA)

測試項目 (Test Items)	測試方法 (Method)	單位 (Unit)	MDL	結果 (Result)
				No.1
聚氯乙烯 (Polyvinyl chloride) (PVC)	參考ASTM E1252: 2013 · 以傅立葉轉換紅外線光譜儀及焰色法分析。(With reference to ASTM E1252: 2013, analysis was performed by FT-IR and Flame Test.)	**	-	Negative
銻 (Sb) (Antimony (Sb)) (CAS No.: 7440-36-0)	參考US EPA 3052: 1996 · 以感應耦合電漿發射光譜儀分析。(With reference to US EPA 3052: 1996, analysis was performed by ICP-OES.)	mg/kg	2	n.d.
鈹 (Be) (Beryllium (Be)) (CAS No.: 7440-41-7)		mg/kg	2	n.d.
砷 (As) (Arsenic (As)) (CAS No.: 7440-38-2)		mg/kg	2	n.d.

備註(Note) :

1. mg/kg = ppm ; 0.1wt% = 1000ppm
2. MDL = Method Detection Limit (方法偵測極限值)
3. n.d. = Not Detected (未檢出) ; 小於MDL / Less than MDL
4. "-" = Not Regulated (無規格值)
5. ** = Qualitative analysis (No Unit) 定性分析(無單位)
6. Negative = Undetectable 陰性(未偵測到); Positive = Detectable 陽性(已偵測到)
7. 全氟辛烷磺酸及其鹽類包含 (PFOS and its salts including) :
CAS No.: 29081-56-9, 2795-39-3, 29457-72-5, 70225-14-8, 56773-42-3, 251099-16-8, 307-35-7.
8. 全氟辛酸及其鹽類包含 (PFOA and its salts including) :
CAS No.: 3825-26-1, 335-95-5, 2395-00-8, 335-93-3, 335-66-0.
9. 樣品的測試是基於申請人要求混合測試 · 報告中的混合測試結果不代表其中個別單一材質的含量。

The sample(s) was/were analyzed on behalf of the applicant as mixing sample in one testing. The above result(s) was/were only given as the informality value.

This document is issued by the Company subject to its General Conditions of Service printed overleaf, available on request or accessible at <https://www.sgs.com.tw/terms-of-service> and, for electronic format documents, subject to Terms and Conditions for Electronic Documents at <https://www.sgs.com.tw/terms-of-service>. Attention is drawn to the limitation of liability, indemnification and jurisdiction issues defined therein. Any holder of this document is advised that information contained hereon reflects the Company's findings at the time of its intervention only and within the limits of client's instruction, if any. The Company's sole responsibility is to its Client and this document does not exonerate parties to a transaction from exercising all their rights and obligations under the transaction documents. This document cannot be reproduced, except in full, without prior written approval of the Company. Any unauthorized alteration, forgery or falsification of the content or appearance of this document is unlawful and offenders may be prosecuted to the fullest extent of the law. Unless otherwise stated the results shown in this test report refer only to the sample(s) tested.

測試報告 Test Report

號碼(No.): ETR21C00682

日期(Date): 10-Dec-2021

頁數(Page): 7 of 15

西北臺慶科技股份有限公司 (TAI-TECH ADVANCED ELECTRONICS CO., LTD.)

臺慶精密電子 (昆山) 有限公司 (TAI-TECH ADVANCED ELECTRONICS (KUN-SHAN) CO., LTD.)

慶邦電子元件 (泗洪) 有限公司 (TAIPAQ ELECTRONICS (SI-HONG) CO., LTD.)

桃園市楊梅區幼獅工業區幼四路1號 (NO. 1, YOU 4TH ROAD, YOUTH INDUSTRIAL DISTRICT, YANG-MEI, TAO-YUAN CITY, TAIWAN R. O. C.)

江蘇省昆山市蓬朗昆嘉高科技工業區郭澤路 (GUO-ZE ROAD, KUNJIA HI-TECH INDUSTRIAL PARK, KUN-SHAN, JIANG-SU, CHINA)

中國 · 江蘇省 · 宿遷市 · 泗洪縣 · 經濟開發區杭州路南側 · 建設北路東側 (THE SOUTH HANGZHOU ROAD AND THE EAST JIANSHE ROAD · ECONOMIC DEVELOPMENT ZONE · SIHONG COUNTY · SUQIANCITY · JIANGSU PROVINCE · P.R · CHINA)

重金屬流程圖 / Analytical flow chart of Heavy Metal

根據以下的流程圖之條件，樣品已完全溶解。(六價鉻測試方法除外)

These samples were dissolved totally by pre-conditioning method according to below flow chart.

(Cr⁶⁺ test method excluded)

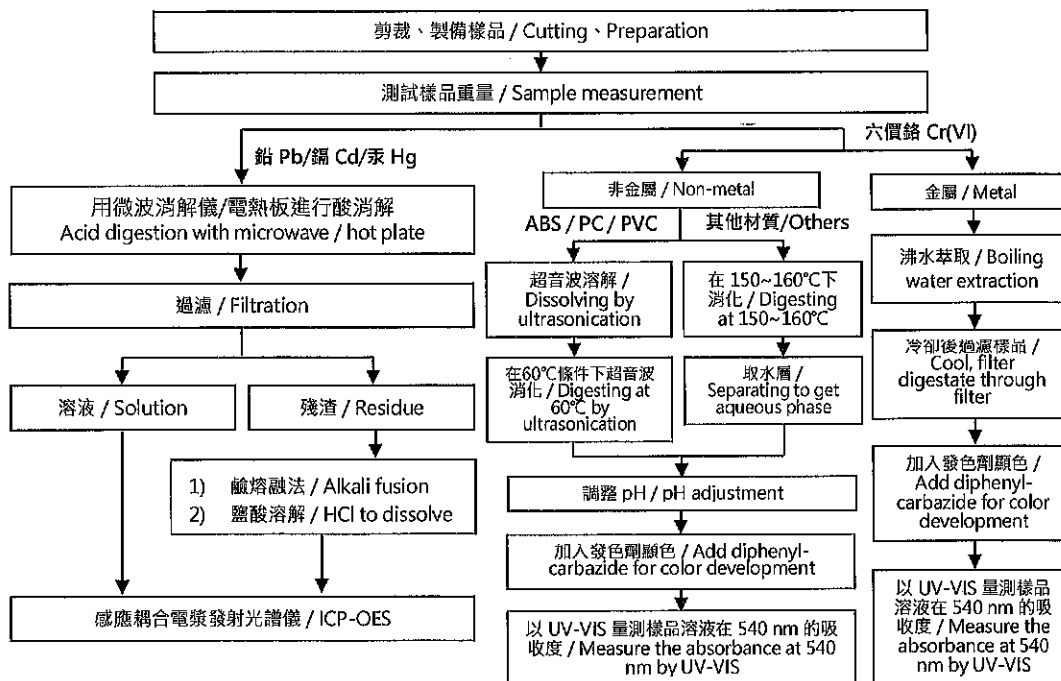

This document is issued by the Company subject to its General Conditions of Service printed overleaf, available on request or accessible at <https://www.sgs.com.tw/terms-of-service> and, for electronic format documents, subject to Terms and Conditions for Electronic Documents at <https://www.sgs.com.tw/terms-of-service>. Attention is drawn to the limitation of liability, indemnification and jurisdiction issues defined therein. Any holder of this document is advised that information contained hereon reflects the Company's findings at the time of its intervention only and within the limits of client's instruction, if any. The Company's sole responsibility is to its Client and this document does not exonerate parties to a transaction from exercising all their rights and obligations under the transaction documents. This document cannot be reproduced, except in full, without prior written approval of the Company. Any unauthorized alteration, forgery or falsification of the content or appearance of this document is unlawful and offenders may be prosecuted to the fullest extent of the law. Unless otherwise stated the results shown in this test report refer only to the sample(s) tested.



測試報告

Test Report

號碼(No.): ETR21C00682

日期(Date): 10-Dec-2021

頁數(Page): 8 of 15

西北臺慶科技股份有限公司 (TAI-TECH ADVANCED ELECTRONICS CO., LTD.)

臺慶精密電子(昆山)有限公司 (TAI-TECH ADVANCED ELECTRONICS (KUN-SHAN) CO., LTD.)

慶邦電子元器件(泗洪)有限公司 (TAIPAQ ELECTRONICS (SI-HONG) CO., LTD.)

桃園市楊梅區幼獅工業區幼四路1號 (NO. 1, YOU 4TH ROAD, YOUTH INDUSTRIAL DISTRICT, YANG-MEI, TAO-YUAN CITY, TAIWAN R. O. C.)

江蘇省昆山市鐘朗昆嘉高科技工業區郭澤路 (GUO-ZE ROAD, KUNJIA HI-TECH INDUSTRIAL PARK, KUN-SHAN, JIANG-SU, CHINA)

中國·江蘇省·宿遷市·泗洪縣·經濟開發區杭州路南側·建設北路東側 (THE SOUTH HANGZHOU ROAD AND THE EAST JIANSHE ROAD · ECONOMIC DEVELOPMENT ZONE · SIHONG COUNTY · SUQIANCITY · JIANGSU PROVINCE · P,R · CHINA)

多溴聯苯/多溴聯苯醚分析流程圖 / Analytical flow chart - PBBs/PBDEs

初次測試程序 / First testing process ———→
選擇性篩檢程序 / Optional screen process ······→
確認程序 / Confirmation process - - - - -→

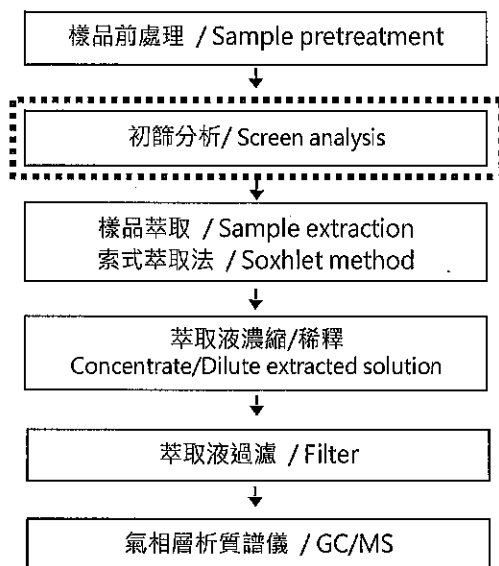

This document is issued by the Company subject to its General Conditions of Service printed overleaf, available on request or accessible at <https://www.sgs.com.tw/terms-of-service> and, for electronic format documents, subject to Terms and Conditions for Electronic Documents at <https://www.sgs.com.tw/terms-of-service>. Attention is drawn to the limitation of liability, indemnification and jurisdiction issues defined therein. Any holder of this document is advised that information contained hereon reflects the Company's findings at the time of its intervention only and within the limits of client's instruction, if any. The Company's sole responsibility is to its Client and this document does not exonerate parties to a transaction from exercising all their rights and obligations under the transaction documents. This document cannot be reproduced, except in full, without prior written approval of the Company. Any unauthorized alteration, forgery or falsification of the content or appearance of this document is unlawful and offenders may be prosecuted to the fullest extent of the law. Unless otherwise stated the results shown in this test report refer only to the sample(s) tested.

測試報告 Test Report

號碼(No.): ETR21C00682

日期(Date): 10-Dec-2021

頁數(Page): 9 of 15

西北臺慶科技股份有限公司 (TAI-TECH ADVANCED ELECTRONICS CO., LTD.)

臺慶精密電子 (昆山) 有限公司 (TAI-TECH ADVANCED ELECTRONICS (KUN-SHAN) CO., LTD.)

慶邦電子元器件 (泗洪) 有限公司 (TAIPAQ ELECTRONICS (SI-HONG) CO., LTD.)

桃園市楊梅區幼獅工業區幼四路1號 (NO. 1, YOU 4TH ROAD, YOUTH INDUSTRIAL DISTRICT, YANG-MEI, TAO-YUAN CITY, TAIWAN R. O. C.)

江蘇省昆山市鐘朗昆嘉高科技工業區郭澤路 (GUO-ZE ROAD, KUNJIA HI-TECH INDUSTRIAL PARK, KUN-SHAN, JIANG-SU, CHINA)

中國 · 江蘇省 · 宿遷市 · 泗洪縣 · 經濟開發區杭州路南側 · 建設北路東側 (THE SOUTH HANGZHOU ROAD AND THE EAST JIANSHE ROAD · ECONOMIC DEVELOPMENT ZONE · SIHONG COUNTY · SUQIANCITY · JIANGSU PROVINCE · P,R · CHINA)

可塑劑分析流程圖 / Analytical flow chart - Phthalate

【測試方法/Test method: IEC 62321-8】

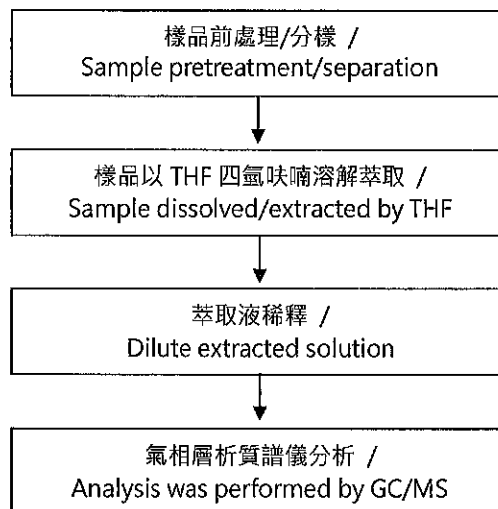

This document is issued by the Company subject to its General Conditions of Service printed overleaf, available on request or accessible at <https://www.sgs.com.tw/terms-of-service> and, for electronic format documents, subject to Terms and Conditions for Electronic Documents at <https://www.sgs.com.tw/terms-of-service>. Attention is drawn to the limitation of liability, indemnification and jurisdiction issues defined therein. Any holder of this document is advised that information contained hereon reflects the Company's findings at the time of its intervention only and within the limits of client's instruction, if any. The Company's sole responsibility is to its Client and this document does not exonerate parties to a transaction from exercising all their rights and obligations under the transaction documents. This document cannot be reproduced, except in full, without prior written approval of the Company. Any unauthorized alteration, forgery or falsification of the content or appearance of this document is unlawful and offenders may be prosecuted to the fullest extent of the law. Unless otherwise stated the results shown in this test report refer only to the sample(s) tested.



測試報告

Test Report

號碼(No.): ETR21C00682

日期(Date): 10-Dec-2021

頁數(Page): 10 of 15

西北臺慶科技股份有限公司 (TAI-TECH ADVANCED ELECTRONICS CO., LTD.)

臺慶精密電子(昆山)有限公司 (TAI-TECH ADVANCED ELECTRONICS (KUN-SHAN) CO., LTD.)

慶邦電子元器件(泗洪)有限公司 (TAIPAQ ELECTRONICS (SI-HONG) CO., LTD.)

桃園市楊梅區幼獅工業區幼四路1號 (NO. 1, YOU 4TH ROAD, YOUTH INDUSTRIAL DISTRICT, YANG-MEI, TAO-YUAN CITY, TAIWAN R. O. C.)

江蘇省昆山市蓬朗昆嘉高科技工業區郭澤路 (GUO-ZE ROAD, KUNJIA HI-TECH INDUSTRIAL PARK, KUN-SHAN, JIANG-SU, CHINA)

中國·江蘇省·宿遷市·泗洪縣·經濟開發區杭州路南側·建設北路東側 (THE SOUTH HANGZHOU ROAD AND THE EAST JIANSHE ROAD · ECONOMIC DEVELOPMENT ZONE · SIHONG COUNTY · SUQIANCITY · JIANGSU PROVINCE · P,R · CHINA)

六溴環十二烷分析流程圖 / Analytical flow chart - HBCDD

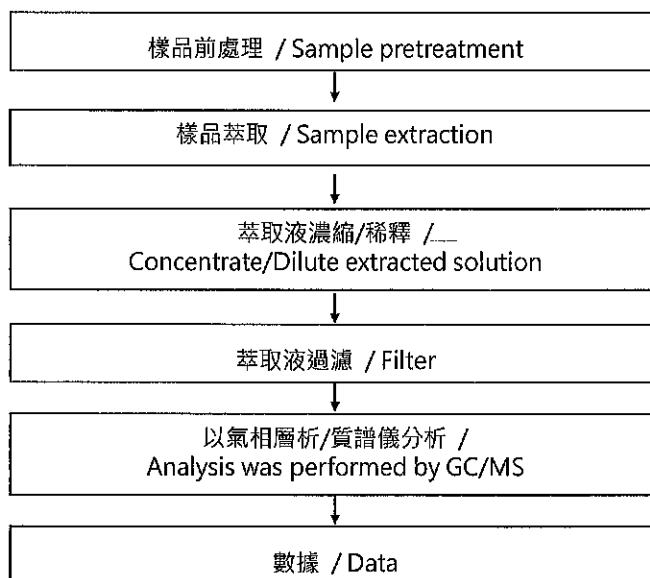

This document is issued by the Company subject to its General Conditions of Service printed overleaf, available on request or accessible at <https://www.sgs.com.tw/terms-of-service> and, for electronic format documents, subject to Terms and Conditions for Electronic Documents at <https://www.sgs.com.tw/terms-of-service>. Attention is drawn to the limitation of liability, indemnification and jurisdiction issues defined therein. Any holder of this document is advised that information contained hereon reflects the Company's findings at the time of its intervention only and within the limits of client's instruction, if any. The Company's sole responsibility is to its Client and this document does not exonerate parties to a transaction from exercising all their rights and obligations under the transaction documents. This document cannot be reproduced, except in full, without prior written approval of the Company. Any unauthorized alteration, forgery or falsification of the content or appearance of this document is unlawful and offenders may be prosecuted to the fullest extent of the law. Unless otherwise stated the results shown in this test report refer only to the sample(s) tested.

測試報告

Test Report

號碼(No.): ETR21C00682

日期(Date): 10-Dec-2021

頁數(Page): 11 of 15

西北臺慶科技股份有限公司 (TAI-TECH ADVANCED ELECTRONICS CO., LTD.)

臺慶精密電子 (昆山) 有限公司 (TAI-TECH ADVANCED ELECTRONICS (KUN-SHAN) CO., LTD.)

慶邦電子元器件 (泗洪) 有限公司 (TAIPAQ ELECTRONICS (SI-HONG) CO., LTD.)

桃園市楊梅區幼獅工業區幼四路1號 (NO. 1, YOU 4TH ROAD, YOUTH INDUSTRIAL DISTRICT, YANG-MEI, TAO-YUAN CITY, TAIWAN R. O. C.)

江蘇省昆山市鐘朗昆嘉高科技工業區郭澤路 (GUO-ZE ROAD, KUNJIA HI-TECH INDUSTRIAL PARK, KUN-SHAN, JIANG-SU, CHINA)

中國 · 江蘇省 · 宿遷市 · 泗洪縣 · 經濟開發區杭州路南側 · 建設北路東側 (THE SOUTH HANGZHOU ROAD AND THE EAST JIANSHE ROAD · ECONOMIC DEVELOPMENT ZONE · SIHONG COUNTY · SUQIANCITY · JIANGSU PROVINCE · P,R · CHINA)

鹵素分析流程圖 / Analytical flow chart - Halogen

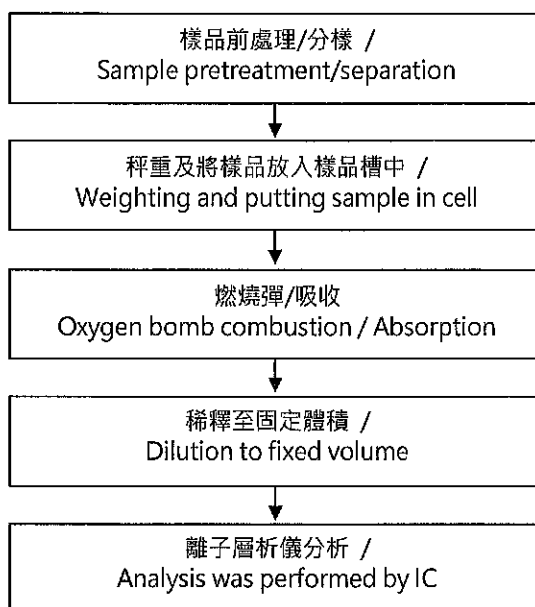

This document is issued by the Company subject to its General Conditions of Service printed overleaf, available on request or accessible at <https://www.sgs.com.tw/terms-of-service> and, for electronic format documents, subject to Terms and Conditions for Electronic Documents at <https://www.sgs.com.tw/terms-of-service>. Attention is drawn to the limitation of liability, indemnification and jurisdiction issues defined therein. Any holder of this document is advised that information contained hereon reflects the Company's findings at the time of its intervention only and within the limits of client's instruction, if any. The Company's sole responsibility is to its Client and this document does not exonerate parties to a transaction from exercising all their rights and obligations under the transaction documents. This document cannot be reproduced, except in full, without prior written approval of the Company. Any unauthorized alteration, forgery or falsification of the content or appearance of this document is unlawful and offenders may be prosecuted to the fullest extent of the law. Unless otherwise stated the results shown in this test report refer only to the sample(s) tested.

測試報告

Test Report

號碼(No.): ETR21C00682

日期(Date): 10-Dec-2021

頁數(Page): 12 of 15

西北臺慶科技股份有限公司 (TAI-TECH ADVANCED ELECTRONICS CO., LTD.)

臺慶精密電子(昆山)有限公司 (TAI-TECH ADVANCED ELECTRONICS (KUN-SHAN) CO., LTD.)

慶邦電子元件(泗洪)有限公司 (TAIPAQ ELECTRONICS (SI-HONG) CO., LTD.)

桃園市楊梅區幼獅工業區幼四路1號 (NO. 1, YOU 4TH ROAD, YOUTH INDUSTRIAL DISTRICT, YANG-MEI, TAO-YUAN CITY, TAIWAN R. O. C.)

江蘇省昆山市蓬朗昆嘉高科技工業區郭澤路 (GUO-ZE ROAD, KUNJIA HI-TECH INDUSTRIAL PARK, KUN-SHAN, JIANG-SU, CHINA)

中國·江蘇省·宿遷市·泗洪縣·經濟開發區杭州路南側·建設北路東側 (THE SOUTH HANGZHOU ROAD AND THE EAST JIANSHE ROAD · ECONOMIC DEVELOPMENT ZONE · SIHONG COUNTY · SUQIANCITY · JIANGSU PROVINCE · P,R · CHINA)

全氟化合物(包含全氟辛酸/全氟辛酸磺酸/其相關化合物等等)分析流程圖 / Analytical flow chart – PFAS (including PFOA/PFOS/its related compound, etc.)

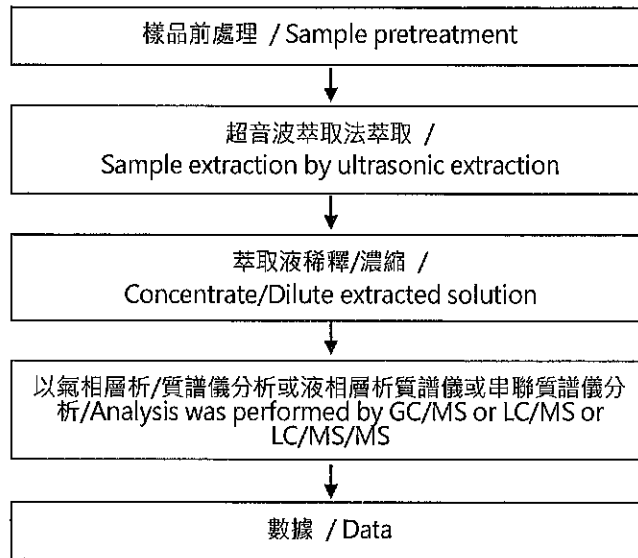

This document is issued by the Company subject to its General Conditions of Service printed overleaf, available on request or accessible at <https://www.sgs.com.tw/terms-of-service> and, for electronic format documents, subject to Terms and Conditions for Electronic Documents at <https://www.sgs.com.tw/terms-of-service>. Attention is drawn to the limitation of liability, indemnification and jurisdiction issues defined therein. Any holder of this document is advised that information contained hereon reflects the Company's findings at the time of its intervention only and within the limits of client's instruction, if any. The Company's sole responsibility is to its Client and this document does not exonerate parties to a transaction from exercising all their rights and obligations under the transaction documents. This document cannot be reproduced, except in full, without prior written approval of the Company. Any unauthorized alteration, forgery or falsification of the content or appearance of this document is unlawful and offenders may be prosecuted to the fullest extent of the law. Unless otherwise stated the results shown in this test report refer only to the sample(s) tested.



測試報告 Test Report

號碼(No.): ETR21C00682

日期(Date): 10-Dec-2021

頁數(Page): 13 of 15

西北臺慶科技股份有限公司 (TAI-TECH ADVANCED ELECTRONICS CO., LTD.)

臺慶精密電子 (昆山) 有限公司 (TAI-TECH ADVANCED ELECTRONICS (KUN-SHAN) CO., LTD.)

慶邦電子元器件 (泗洪) 有限公司 (TAIPAQ ELECTRONICS (SI-HONG) CO., LTD.)

桃園市楊梅區幼獅工業區幼四路1號 (NO. 1, YOU 4TH ROAD, YOUTH INDUSTRIAL DISTRICT, YANG-MEI, TAO-YUAN CITY, TAIWAN R. O. C.)

江蘇省昆山市蓬朗區嘉高科技工業區郭澤路 (GUO-ZE ROAD, KUNJIA HI-TECH INDUSTRIAL PARK, KUN-SHAN, JIANG-SU, CHINA)

中國 · 江蘇省 · 宿遷市 · 泗洪縣 · 經濟開發區杭州路南側 · 建設北路東側 (THE SOUTH HANGZHOU ROAD AND THE EAST JIANSHE ROAD · ECONOMIC DEVELOPMENT ZONE · SIHONG COUNTY · SUQIANCITY · JIANGSU PROVINCE · P,R · CHINA)

聚氯乙烯物質判定分析流程圖 / Analysis flow chart - PVC

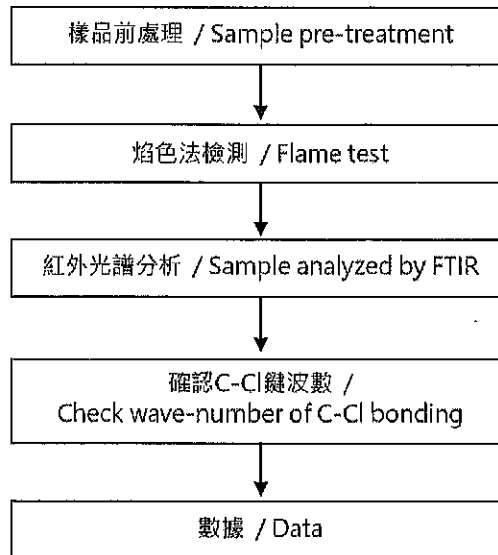

This document is issued by the Company subject to its General Conditions of Service printed overleaf, available on request or accessible at <https://www.sgs.com.tw/terms-of-service> and, for electronic format documents, subject to Terms and Conditions for Electronic Documents at <https://www.sgs.com.tw/terms-of-service>. Attention is drawn to the limitation of liability, indemnification and jurisdiction issues defined therein. Any holder of this document is advised that information contained hereon reflects the Company's findings at the time of its intervention only and within the limits of client's instruction, if any. The Company's sole responsibility is to its Client and this document does not exonerate parties to a transaction from exercising all their rights and obligations under the transaction documents. This document cannot be reproduced, except in full, without prior written approval of the Company. Any unauthorized alteration, forgery or falsification of the content or appearance of this document is unlawful and offenders may be prosecuted to the fullest extent of the law. Unless otherwise stated the results shown in this test report refer only to the sample(s) tested.



測試報告

Test Report

號碼(No.): ETR21C00682

日期(Date): 10-Dec-2021

頁數(Page): 14 of 15

西北臺慶科技股份有限公司 (TAI-TECH ADVANCED ELECTRONICS CO., LTD.)

臺慶精密電子 (昆山) 有限公司 (TAI-TECH ADVANCED ELECTRONICS (KUN-SHAN) CO., LTD.)

慶邦電子元件 (泗洪) 有限公司 (TAIPAQ ELECTRONICS (SI-HONG) CO., LTD.)

桃園市楊梅區幼獅工業區幼四路1號 (NO. 1, YOU 4TH ROAD, YOUTH INDUSTRIAL DISTRICT, YANG-MEI, TAO-YUAN CITY, TAIWAN R. O. C.)

江蘇省昆山市蓬朗昆嘉高科技工業區郭澤路 (GUO-ZE ROAD, KUNJIA HI-TECH INDUSTRIAL PARK, KUN-SHAN, JIANG-SU, CHINA)

中國·江蘇省·宿遷市·泗洪縣·經濟開發區杭州路南側·建設北路東側 (THE SOUTH HANGZHOU ROAD AND THE EAST JIANSHE ROAD·ECONOMIC DEVELOPMENT ZONE·SIHONG COUNTY·SUQIANCITY·JIANGSU PROVINCE·P,R·CHINA)

元素(含重金屬)分析流程圖 / Analytical flow chart of Elements (Heavy metal included)

根據以下的流程圖之條件·樣品已完全溶解。

These samples were dissolved totally by pre-conditioning method according to below flow chart.

【參考方法/Reference method : US EPA 3051A · US EPA 3052】

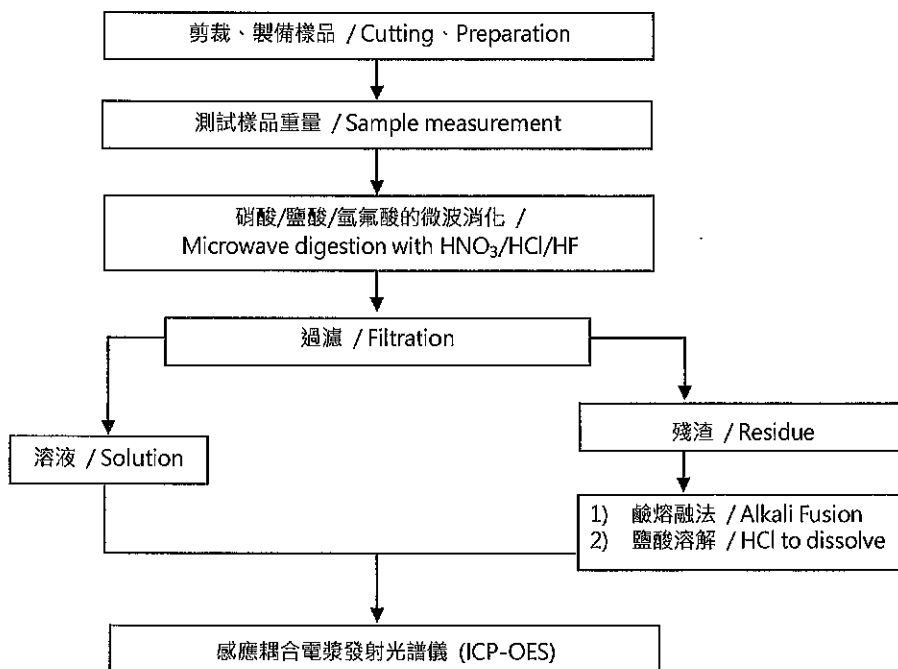

* US EPA 3051A 方法未添加氫氟酸 / US EPA 3051A method does not add HF.

This document is issued by the Company subject to its General Conditions of Service printed overleaf, available on request or accessible at <https://www.sgs.com.tw/terms-of-service> and, for electronic format documents, subject to Terms and Conditions for Electronic Documents at <https://www.sgs.com.tw/terms-of-service>. Attention is drawn to the limitation of liability, indemnification and Jurisdiction issues defined therein. Any holder of this document is advised that information contained hereon reflects the Company's findings at the time of its intervention only and within the limits of client's instruction, if any. The Company's sole responsibility is to its Client and this document does not exonerate parties to a transaction from exercising all their rights and obligations under the transaction documents. This document cannot be reproduced, except in full, without prior written approval of the Company. Any unauthorized alteration, forgery or falsification of the content or appearance of this document is unlawful and offenders may be prosecuted to the fullest extent of the law. Unless otherwise stated the results shown in this test report refer only to the sample(s) tested.

測試報告

Test Report

號碼(No.): ETR21C00682

日期(Date): 10-Dec-2021

頁數(Page): 15 of 15

西北臺慶科技股份有限公司 (TAI-TECH ADVANCED ELECTRONICS CO., LTD.)

臺慶精密電子 (昆山) 有限公司 (TAI-TECH ADVANCED ELECTRONICS (KUN-SHAN) CO., LTD.)

慶邦電子元器件 (泗洪) 有限公司 (TAIPAQ ELECTRONICS (SI-HONG) CO., LTD.)

桃園市楊梅區幼獅工業區幼四路1號 (NO. 1, YOU 4TH ROAD, YOUTH INDUSTRIAL DISTRICT, YANG-MEI, TAO-YUAN CITY, TAIWAN R. O. C.)

江蘇省昆山市鐘朗昆嘉高科技工業區郭澤路 (GUO-ZE ROAD, KUNJIA HI-TECH INDUSTRIAL PARK, KUN-SHAN, JIANG-SU, CHINA)

中國·江蘇省·宿遷市·泗洪縣·經濟開發區杭州路南側·建設北路東側 (THE SOUTH HANGZHOU ROAD AND THE EAST JIANSHE ROAD · ECONOMIC DEVELOPMENT ZONE · SIHONG COUNTY · SUQIANCITY · JIANGSU PROVINCE · P.R · CHINA)

* 照片中如有箭頭標示·則表示為實際檢測之樣品/部位.*

(The tested sample / part is marked by an arrow if it's shown on the photo.)

ETR21C00682

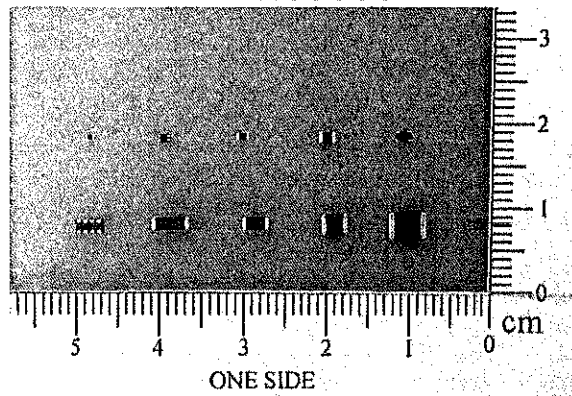

ETR21C00682

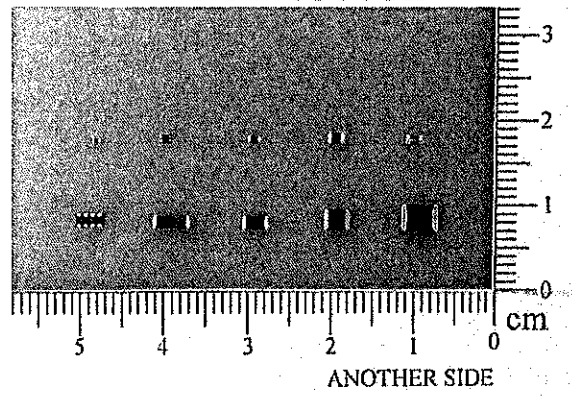

** 報告結尾 (End of Report) **

This document is issued by the Company subject to its General Conditions of Service printed overleaf, available on request or accessible at <https://www.sgs.com.tw/terms-of-service> and, for electronic format documents, subject to Terms and Conditions for Electronic Documents at <https://www.sgs.com.tw/terms-of-service>. Attention is drawn to the limitation of liability, indemnification and jurisdiction issues defined therein. Any holder of this document is advised that information contained hereon reflects the Company's findings at the time of its intervention only and within the limits of client's instruction, if any. The Company's sole responsibility is to its Client and this document does not exonerate parties to a transaction from exercising all their rights and obligations under the transaction documents. This document cannot be reproduced, except in full, without prior written approval of the Company. Any unauthorized alteration, forgery or falsification of the content or appearance of this document is unlawful and offenders may be prosecuted to the fullest extent of the law. Unless otherwise stated the results shown in this test report refer only to the sample(s) tested.

单击下面可查看定价，库存，交付和生命周期等信息

[>>TAI-TECH\(台庆\)](#)