

Applicable for automotive exterior light

3014 Series Top View LED

STAPE1LZ

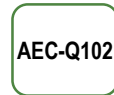

Product Brief

Description

- This Amber Colored surface-mount LED comes in standard package dimension. Package size: 3.0×1.4×0.52mm
- It has a substrate made up of a molded plastic reflector sitting on top of a lead frame.
- The die is attached within the reflector cavity and the cavity is encapsulated by silicone.
- The package design coupled with careful selection of component materials allow these products to perform with high reliability.

Features and Benefits

- SMD epoxy package
- High reliability by EMC
- ESD class 3B
- Viewing angle 120°
- RoHS compliant

Key Applications

- Automotive Exterior Lighting

Table of Contents

Index	
• Product Brief	1
• Table of Contents	2
• Performance Characteristics	3
• Characteristics Graph	5
• Color Bin Structure	11
• Mechanical Dimensions	13
• Reflow Soldering Characteristics	14
• Reel Packaging & Emitter Tape	15
• Product Nomenclature	17
• Handling of Silicone Resin for LEDs	18
• Precaution For Use	19
• Company Information	21

Performance Characteristics

Table 1. Electro Optical Characteristics, $I_F=140mA$, $T_a=25^{\circ}C$, RH30%

Parameter	Symbol	Value			Unit
		Min	Typ	Max	
Forward Voltage [1]	V_F	2.75	3.15	3.50	V
Reverse Voltage	V_R ($I_R=5mA$)		0.8	1.3	V
Luminous Flux [1][2]	Φ_V	32.0	36.5	47.5	lm
Color Chromaticity Coordinates [1][3]	CIE x		0.571		
	CIE y		0.416		
Viewing Angle [4]	$2\theta_{1/2}$	-	120	-	deg.
Electrical Thermal resistance	$R_{th JS}$ el	-	23	28	K / W
Real Thermal resistance	$R_{th JS}$ $real$	-	32	40	K / W

Notes :

[1] Tolerance : VF : $\pm 0.1V$, LF : $\pm 7\%$, X,Y : ± 0.005

[2] The luminous flux was measured at the peak of the spatial pattern which may not be aligned with the mechanical axis of the LED package.

[3] Correlated Color is derived from the CIE 1931 Chromaticity diagram.

[4] $\theta_{1/2}$ is the off-axis where the luminous intensity is 1/2 of the peak intensity

[5] Thermal resistance = Rth JS : Junction/solder point . Rth max is based on statistic values

※ Not applicable for reverse operation

Performance Characteristics

Table 2. Absolute Maximum Ratings ($T_a=25^{\circ}\text{C}$)

Parameter	Symbol	Value	Unit
Power Dissipation	P_d	875	mW
DC Forward Current	I_F	250	mA
Peak Forward Current (1/10 Duty, $f=1\text{kHz}$, $T_j=25^{\circ}\text{C}$)	I_{FM}	280	mA
Operating Temperature	T_{opr}	-40 ~ +125	$^{\circ}\text{C}$
Storage Temperature	T_{stg}	-40 ~ +125	$^{\circ}\text{C}$
Junction Temperature	$T_j \text{ max}$	150	$^{\circ}\text{C}$
Soldering Temperature	T_{sld}	Reflow Soldering : 260 $^{\circ}\text{C}$ for 10sec. Hand Soldering : 315 $^{\circ}\text{C}$ for 4sec.	
ESD (HBM) ($R=1.5\text{k}\Omega$, $C=100\text{pF}$) ⁽¹⁾		Class 3B (EIA/JESD22-A114)	

Notes :

(1) ESD protection device is included

- LED's properties might be different from suggested values like above and below tables if operation condition will be exceeded our parameter range. Care is to be taken that power dissipation does not exceed the absolute maximum rating of the product.
- All measurements were made under the standardized environment of Seoul Semiconductor.

Characteristics Graph

Fig 1. Color Spectrum, $I_F = 140\text{mA}$, $T_a = 25^\circ\text{C}$

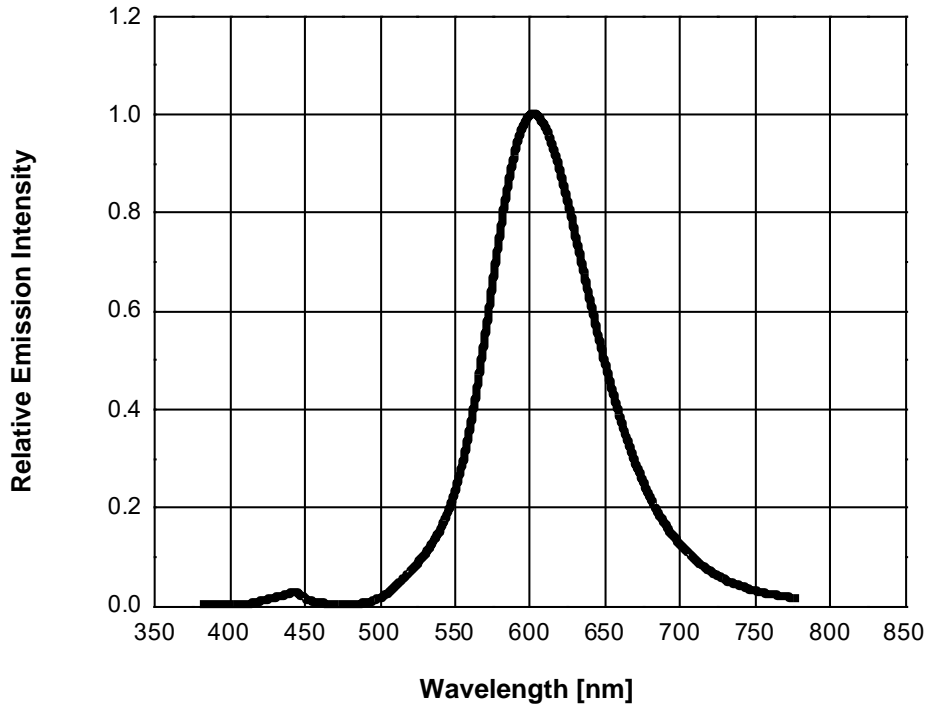
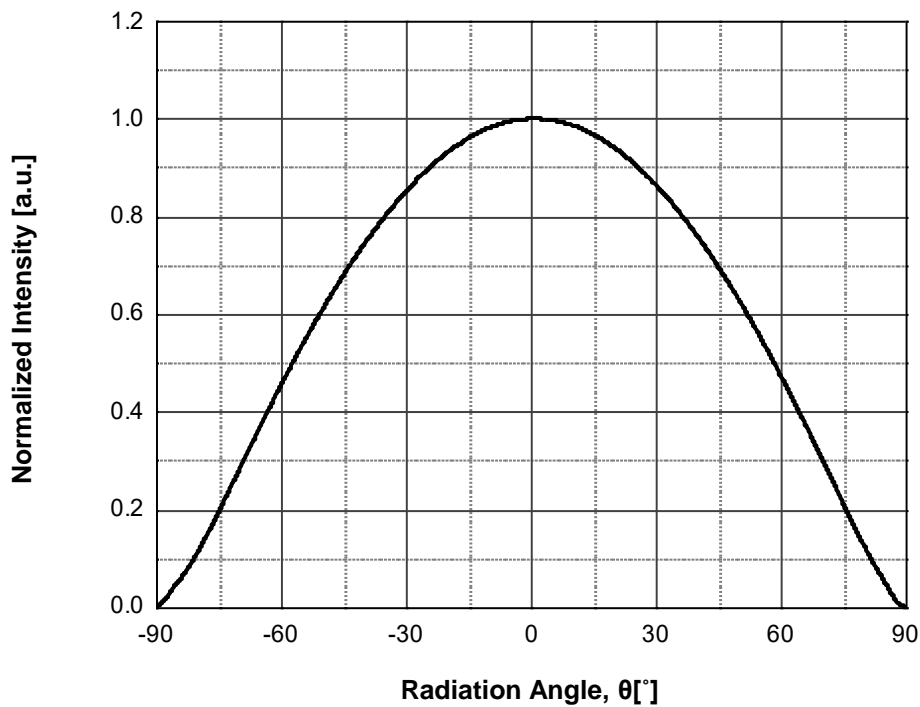

Fig 2. Viewing Angle Distribution, $I_F = 140\text{mA}$



Characteristics Graph

Fig 3. Forward Voltage vs. Forward Current, $T_a = 25^\circ\text{C}$

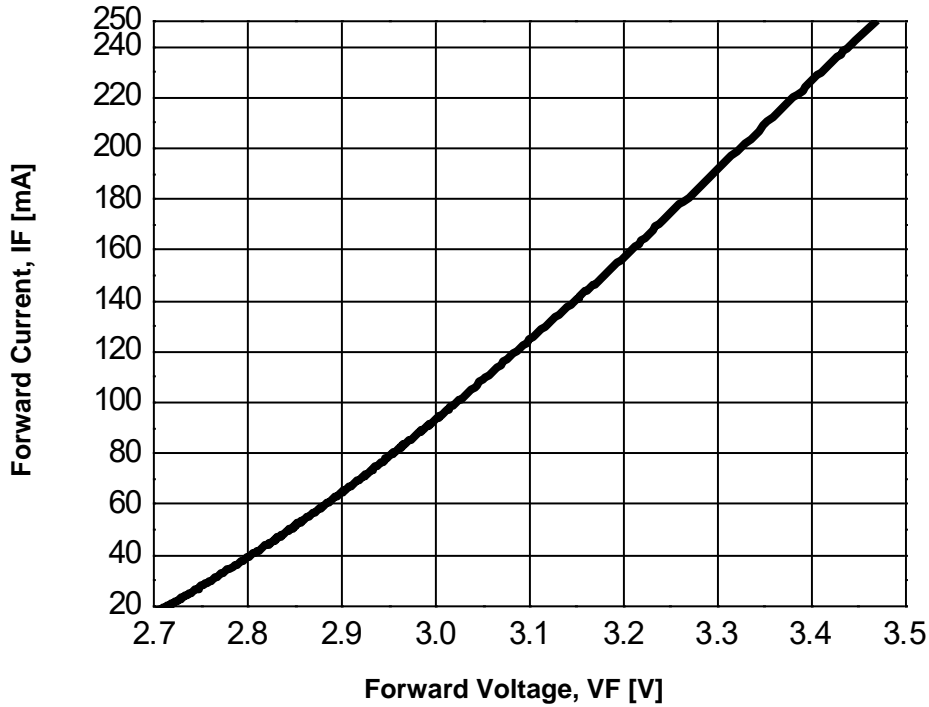
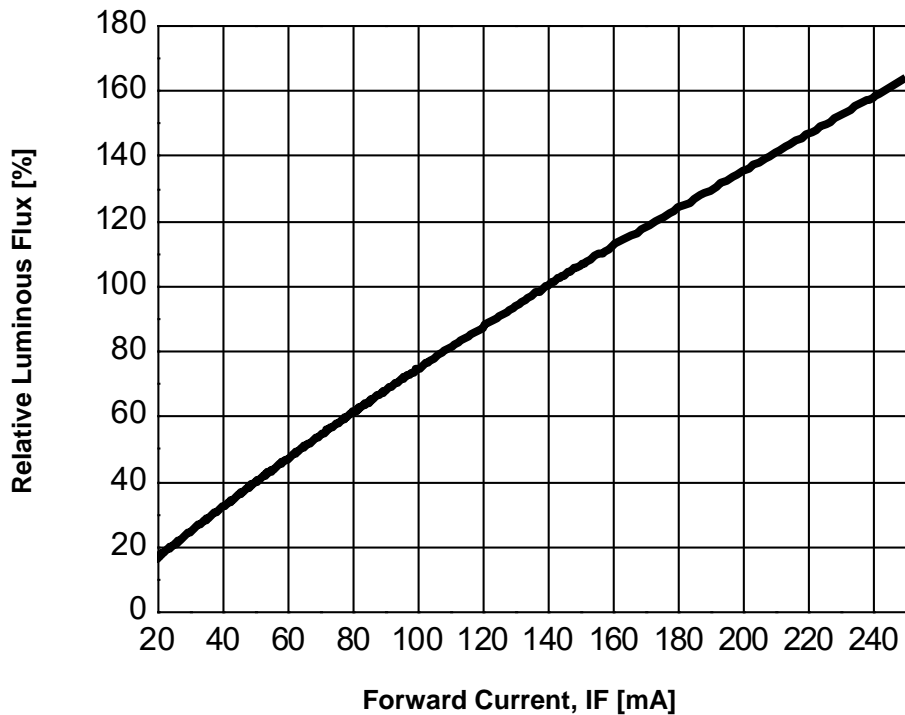
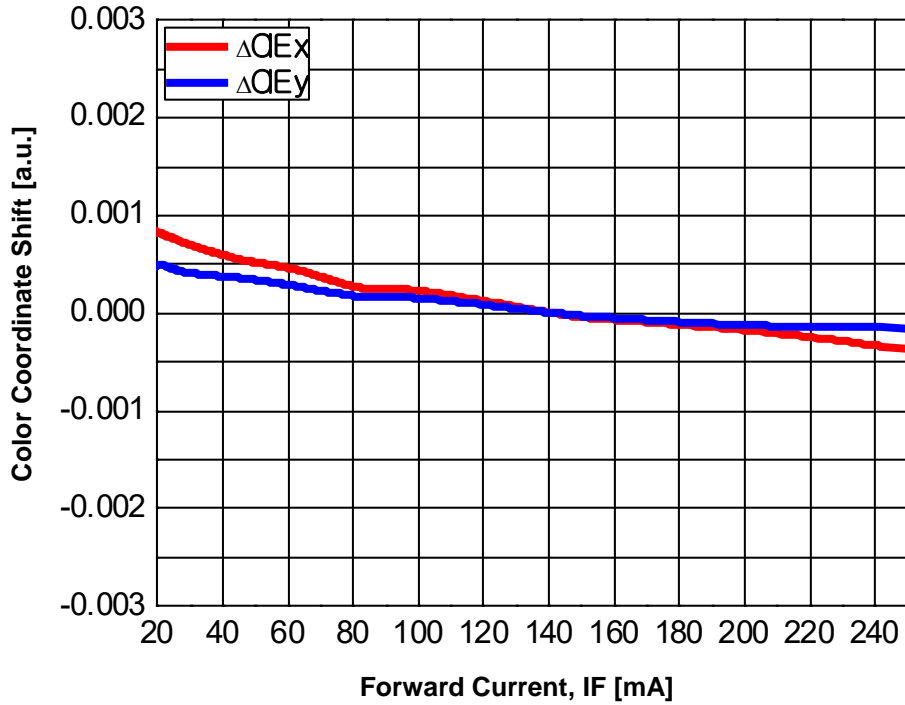

Fig 4. Forward Current vs. Relative Luminous Flux, $T_a = 25^\circ\text{C}$



Characteristics Graph

Fig 5. Forward Current vs. Color Coordinate Shift , $T_a = 25^\circ\text{C}$



Characteristics Graph

Fig 6. Junction Temperature vs. Relative Luminous Flux, $I_F = 140\text{mA}$

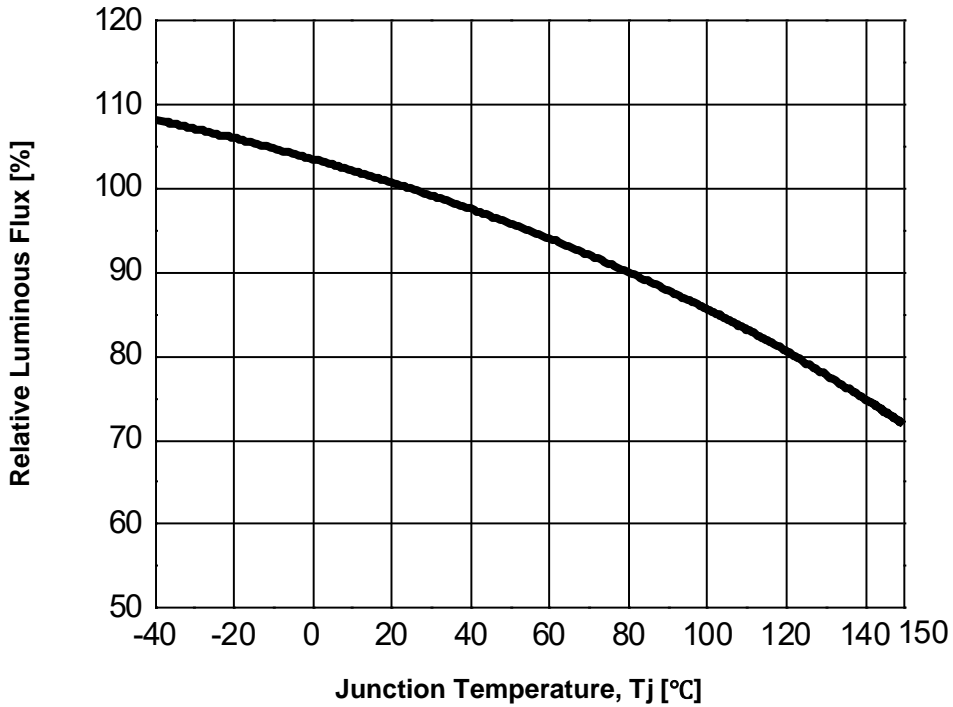
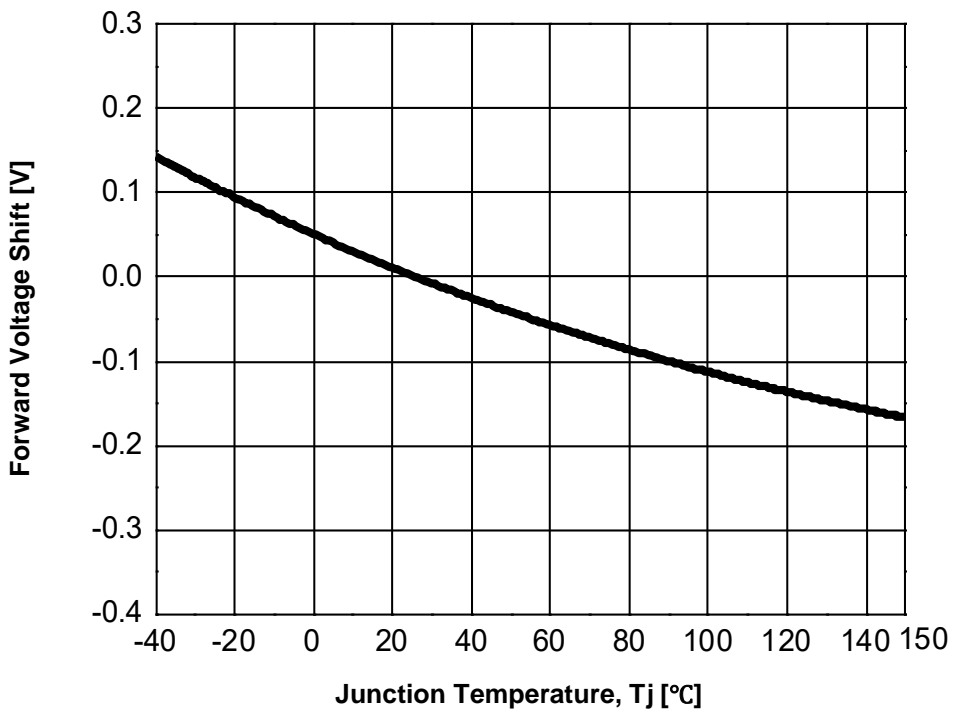
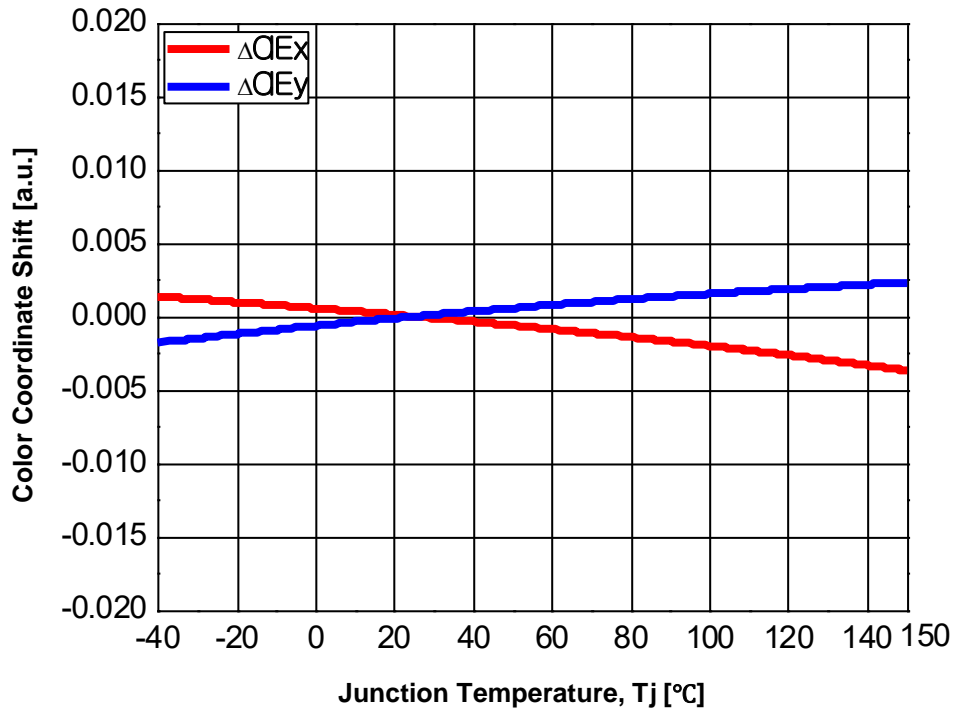

Fig 7. Junction Temperature vs. Forward Voltage shift, $I_F = 140\text{mA}$



Characteristics Graph

Fig 8. Junction Temperature vs. Color Coordinate Shift, $I_F = 140\text{mA}$



Characteristics Graph

Fig 9. Maximum Allowable Forward Current vs Solder Temperature

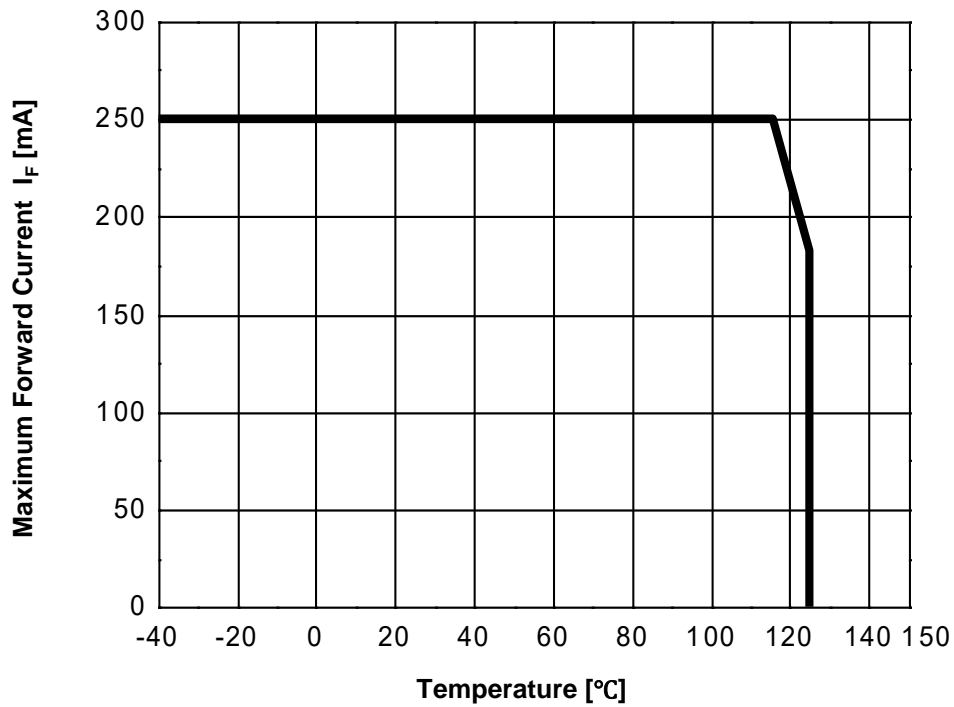

Color Bin Structure

Table 3. Bin Code description, $T_a=25^{\circ}\text{C}$, $I_F = 140\text{mA}$

Part Number	Luminous Flux (lm)			Color Chromaticity Coordinate	Typical Forward Voltage (V)		
	Bin Code	Min.	Max.		Bin Code	Min.	Max.
STAPE1LZ	Q1	32.0	36.5	Refer to Next Page	G	2.75	3.00
	Q2	36.5	41.5		H	3.00	3.25
	R1	41.5	47.5		I	3.25	3.50

 Available Ranks

※ Bin Code Description can be changed before mass production.

Color Bin Structure

CIE Chromaticity Diagram, $T_a=25^\circ\text{C}$, $I_F = 140\text{mA}$

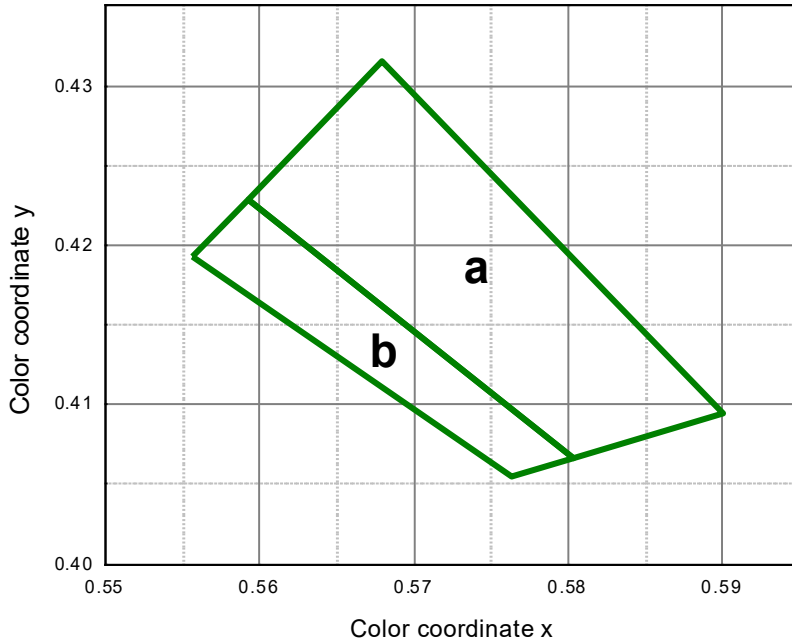

RANK	x1	y1	x2	y2
	x3	y3	x4	y4
a	0.5593	0.4228	0.5804	0.4066
	0.5901	0.4094	0.5680	0.4315
b	0.5557	0.4192	0.5763	0.4054
	0.5804	0.4066	0.5593	0.4228

Mechanical Dimensions

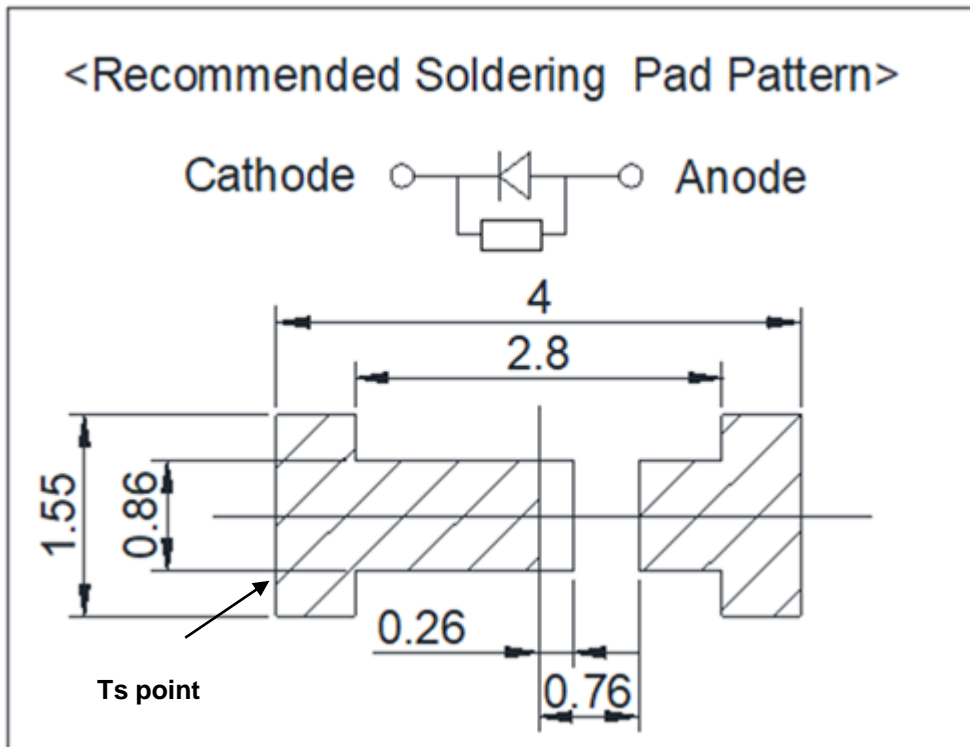
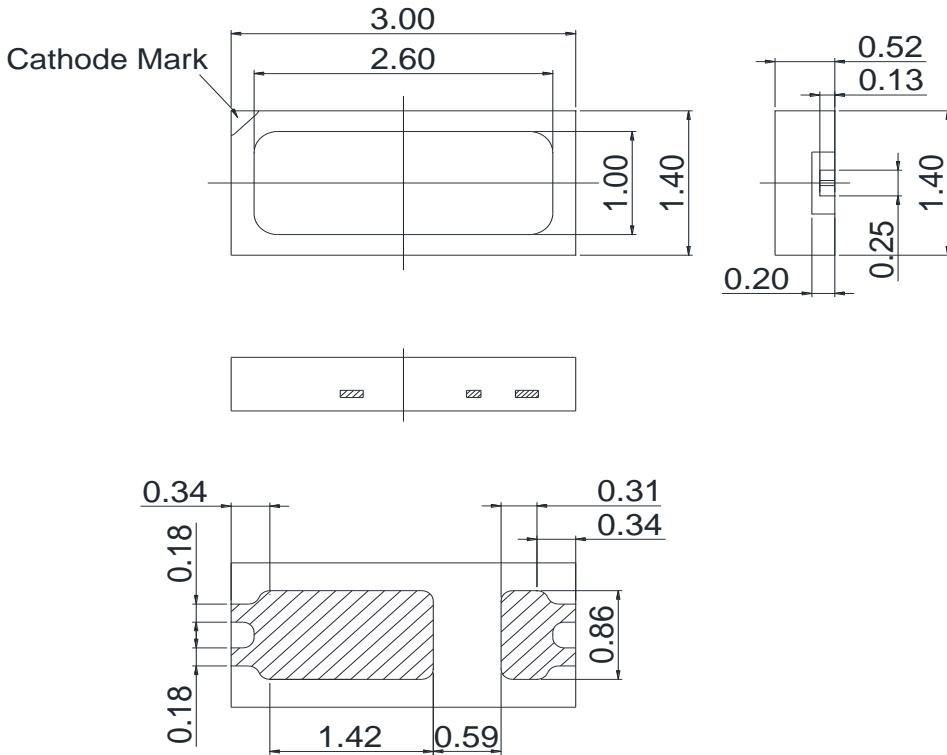

*Tolerance: ± 0.1 , Unit: mm

Reflow Soldering Characteristics

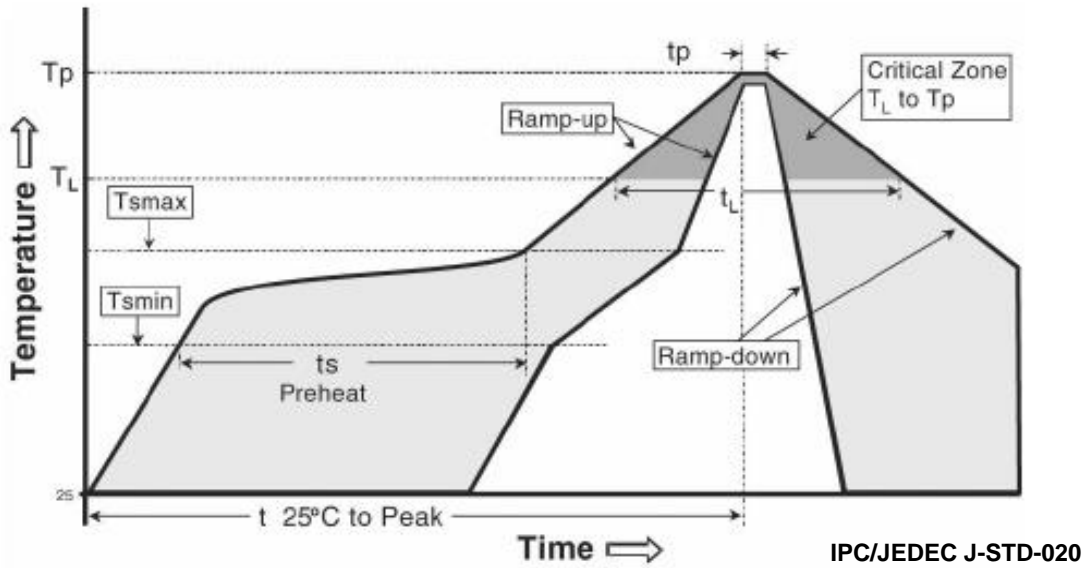

Profile Feature	Sn-Pb Eutectic Assembly	Pb-Free Assembly
Average ramp-up rate (T _{max} to T _p)	3° C/second max.	3° C/second max.
Preheat - Temperature Min (T _{min}) - Temperature Max (T _{max}) - Time (T _{min} to T _{max}) (t _s)	100 °C 150 °C 60-120 seconds	150 °C 200 °C 60-180 seconds
Time maintained above: - Temperature (T _L) - Time (t _L)	183 °C 60-150 seconds	217 °C 60-150 seconds
Peak Temperature (T _p)	215°C	260°C
Time within 5°C of actual Peak Temperature (t _p) ²	10-30 seconds	20-40 seconds
Ramp-down Rate	6 °C/second max.	6 °C/second max.
Time 25°C to Peak Temperature	6 minutes max.	8 minutes max.

Caution

- (1) Reflow soldering is recommended not to be done more than two times. In the case of more than 24 hours passed soldering after first, LEDs will be damaged.
- (2) Repairs should not be done after the LEDs have been soldered. When repair is unavoidable, suitable tools must be used.
- (3) Die slug is to be soldered.
- (4) When soldering, do not put stress on the LEDs during heating.
- (5) After soldering, do not warp the circuit board.

Emitter Tape & Reel Packaging

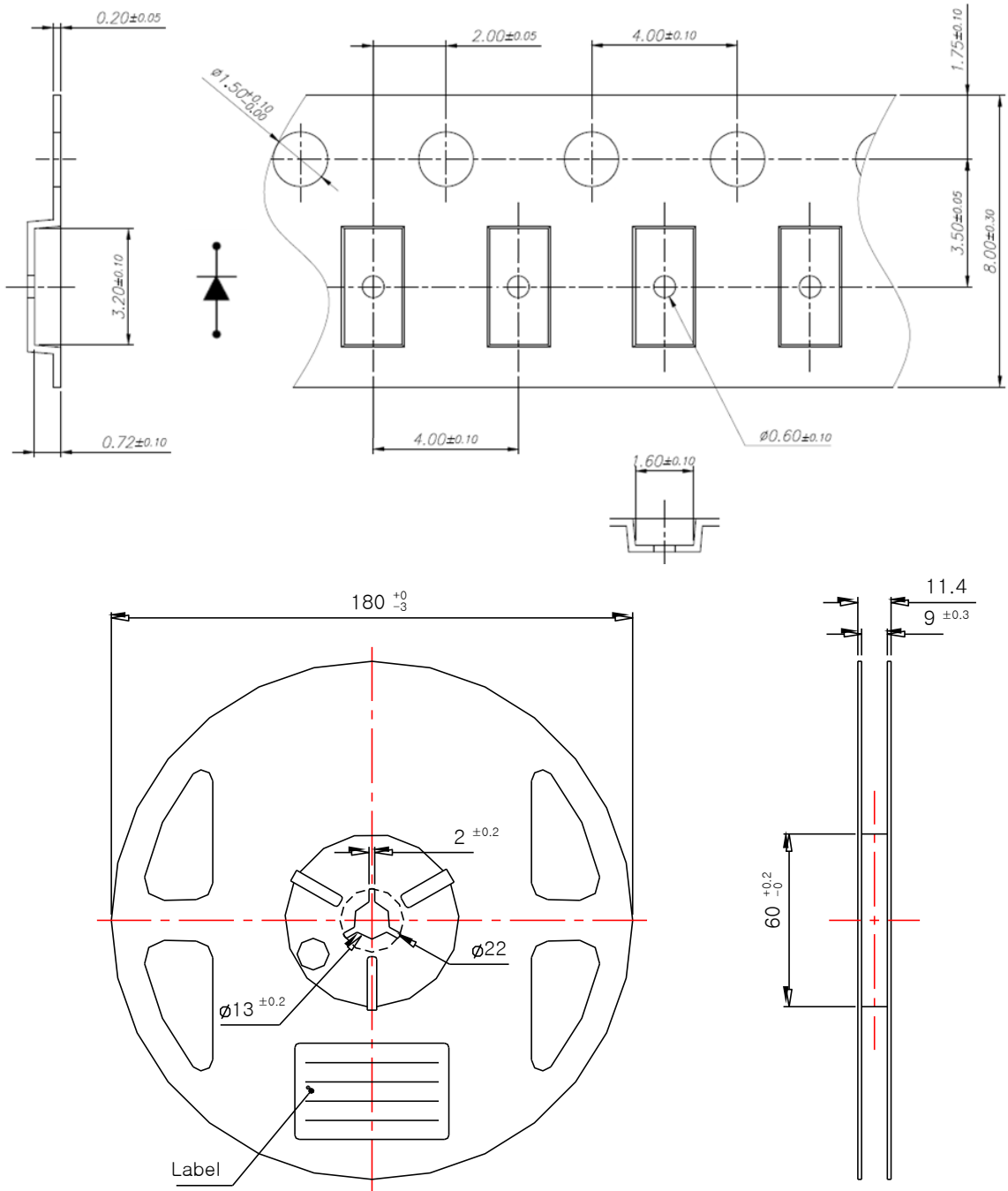

- (1) Quantity : 5000pcs/Reel
- (2) Cumulative Tolerance : Cumulative Tolerance/10 pitches to be $\pm 0.2\text{mm}$
- (3) Adhesion Strength of Cover Tape : Adhesion strength to be 0.1-0.7N when the cover tape is turned off from the carrier tape at the angle of 10° to the carrier tape
- (4) Package : P/N, Manufacturing data Code No. and quantity to be indicated on a damp proof Package

Emitter Tape & Reel Packaging

Reel

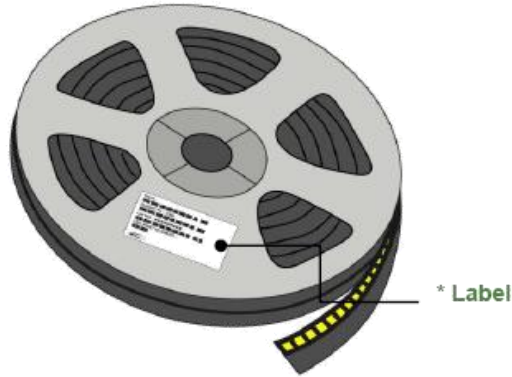

Aluminum Bag



* Label

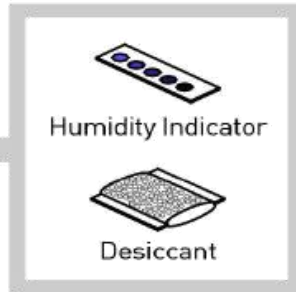
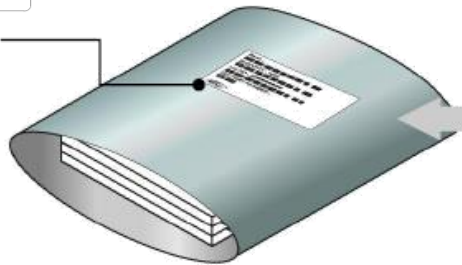

Outer Box

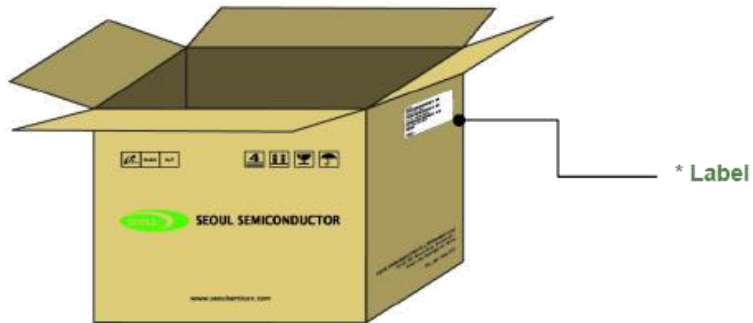

Product Nomenclature

Table 4. Part Numbering System : X₁X₂X₃X₄X₅X₆X₇X₈

Part Number Code	Description	Part Number	Value
X ₁	Company	S	SSC
X ₂	Package Type	T	Top View LED
X ₃ X ₄	Color Specification	AP	PC-Amber
X ₅	Package series	E	3014 series
X ₆	Chip No	1	1 Chip
X ₇	Characteristic code	L	0.5W
X ₈	Revision	Z	-

Table 5. Lot Numbering System : Y₁Y₂Y₃Y₄Y₅Y₆Y₇Y₈Y₉Y₁₀-Y₁₁Y₁₂Y₁₃Y₁₄Y₁₅Y₁₆Y₁₇

Lot Number Code	Description	Lot Number	Value
Y ₁ Y ₂	Year		
Y ₃	Month		
Y ₄ Y ₅	Day		
Y ₆	Top View LED series		
Y ₇ Y ₈ Y ₉ Y ₁₀	Mass order		
Y ₁₁ Y ₁₂ Y ₁₃ Y ₁₄ Y ₁₅ Y ₁₆ Y ₁₇	Internal Number		

Handling of Silicone Resin for LEDs

(1) During processing, mechanical stress on the surface should be minimized as much as possible. Sharp objects of all types should not be used to pierce the sealing compound.



(2) In general, LEDs should only be handled from the side. By the way, this also applies to LEDs without a silicone sealant, since the surface can also become scratched.

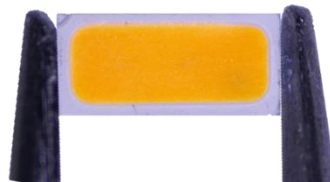

(3) When populating boards in SMT production, there are basically no restrictions regarding the form of the pick and place nozzle, except that mechanical pressure on the surface of the resin must be prevented. This is assured by choosing a pick and place nozzle which is larger than the LED's reflector area.

(4) Silicone differs from materials conventionally used for the manufacturing of LEDs. These conditions must be considered during the handling of such devices. Compared to standard encapsulants, silicone is generally softer, and the surface is more likely to attract dust.

As mentioned previously, the increased sensitivity to dust requires special care during processing. In cases where a minimal level of dirt and dust particles cannot be guaranteed, a suitable cleaning solution must be applied to the surface after the soldering of components.

(5) Seoul Semiconductor suggests using isopropyl alcohol for cleaning. In case other solvents are used, it must be assured that these solvents do not dissolve the package or resin. Ultrasonic cleaning is not recommended. Ultrasonic cleaning may cause damage to the LED.

(6) Please do not mold this product into another resin (epoxy, urethane, etc) and do not handle this product with acid or sulfur material in sealed space.

Precaution for Use

(1) Storage

To avoid the moisture penetration, we recommend storing LEDs in a dry box with a desiccant . The recommended storage temperature range is 5°C to 30°C and a maximum humidity of RH50%.

(2) Use Precaution after Opening the Packaging

Use proper SMD techniques when the LED is to be soldered dipped as separation of the lens may affect the light output efficiency.

Pay attention to the following:

a. Recommend conditions after opening the package

- Sealing / Temperature : 5 ~ 30°C Humidity : less than RH60%

b. If the package has been opened more than 1 year (MSL 2) or the color of

the desiccant changes, components should be dried for 10-24hr at 65±5°C

(3) Do not apply mechanical force or excess vibration during the cooling process to normal temperature after soldering.

(4) Do not rapidly cool device after soldering.

(5) Components should not be mounted on warped (non coplanar) portion of PCB.

(6) Radioactive exposure is not considered for the products listed here in.

(7) Gallium arsenide is used in some of the products listed in this publication. These products are dangerous if they are burned or shredded in the process of disposal. It is also dangerous to drink the liquid or inhale the gas generated by such products when chemically disposed of.

(8) This device should not be used in any type of fluid such as water, oil, organic solvent and etc. When washing is required, IPA (Isopropyl Alcohol) should be used.

(9) When the LEDs are in operation the maximum current should be decided after measuring the package temperature.

(10) LEDs must be stored in a clean environment. We recommend LEDs store in nitrogen-filled container.

(11) The appearance and specifications of the product may be modified for improvement without notice.

(12) Long time exposure of sunlight or occasional UV exposure will cause lens discoloration.

Precaution for Use

(13) VOCs (Volatile organic compounds) emitted from materials used in the construction of fixtures can penetrate silicone encapsulants of LEDs and discolor when exposed to heat and photonic energy. The result can be a significant loss of light output from the fixture. Knowledge of the properties of the materials selected to be used in the construction of fixtures can help prevent these issues.

(14) The slug is electrically isolated.

(15) Attaching LEDs, do not use adhesives that outgas organic vapor.

(16) The driving circuit must be designed to allow forward voltage only when it is ON or OFF. If the reverse voltage is applied to LED, migration can be generated resulting in LED damage.

(17) LEDs are sensitive to Electro-Static Discharge (ESD) and Electrical Over Stress (EOS). Below is a list of suggestions that Seoul Semiconductor purposes to minimize these effects.

a. ESD (Electro Static Discharge)

Electrostatic discharge (ESD) is defined as the release of static electricity when two objects come into contact. While most ESD events are considered harmless, it can be an expensive problem in many industrial environments during production and storage. The damage from ESD to LEDs may cause the product to demonstrate unusual characteristics such as:

- Increase in reverse leakage current lowered turn-on voltage
- Abnormal emissions from the LED at low current

The following recommendations are suggested to help minimize the potential for an ESD event. One or more recommended work area suggestions:

- Ionizing fan setup
- ESD table/shelf mat made of conductive materials
- ESD safe storage containers

One or more personnel suggestion options:

- Antistatic wrist-strap
- Antistatic material shoes
- Antistatic clothes

Environmental controls:

- Humidity control (ESD gets worse in a dry environment)



Company Information

Published by

Seoul Semiconductor © 2021 All Rights Reserved.

Company Information

Seoul Semiconductor (www.SeoulSemicon.com) manufactures and packages a wide selection of light emitting diodes (LEDs) for the automotive, general illumination/lighting, Home appliance, signage and back lighting markets. The company is the world's fifth largest LED supplier, holding more than 10,000 patents globally, while offering a wide range of LED technology and production capacity in areas such as "nPola", "Acrich", the world's first commercially produced AC LED, and "Acrich MJT - Multi-Junction Technology" a proprietary family of high-voltage LEDs.

The company's broad product portfolio includes a wide array of package and device choices such as Acrich and Acirch2, high-brightness LEDs, mid-power LEDs, side-view LEDs, and through-hole type LEDs as well as custom modules, displays, and sensors.

Legal Disclaimer

Information in this document is provided in connection with Seoul Semiconductor products. With respect to any examples or hints given herein, any typical values stated herein and/or any information regarding the application of the device, Seoul Semiconductor hereby disclaims any and all warranties and liabilities of any kind, including without limitation, warranties of non-infringement of intellectual property rights of any third party. The appearance and specifications of the product can be changed to improve the quality and/or performance without notice.